

This Owner's Manual is provided and hosted by [Appliance Factory Parts](#).

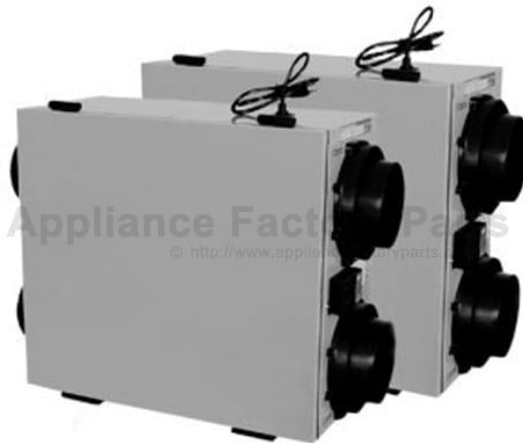

GENERAL 8160 Owner's Manual

[Shop genuine replacement parts for GENERAL 8160](#)



[Find Your GENERAL HVAC Parts - Select From 4 Models](#)

----- Manual continues below -----

GENERAL Aire

Fresh Indoor Air Quality

INSTALLATION GUIDE

Horizontal series

HRV MODEL 8160 and MODEL 8220

ERV MODEL 3160 and MODEL 3220

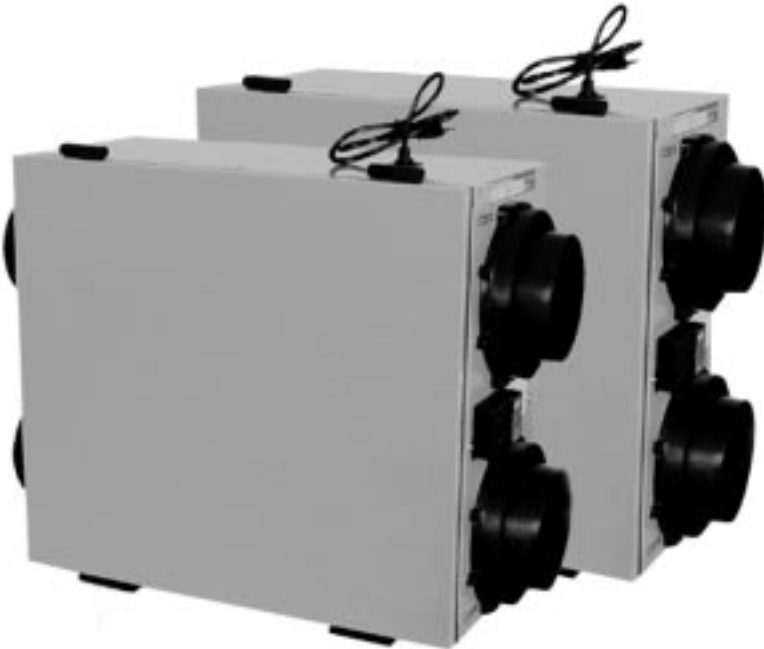

INSTALLATION GUIDE



Peace of Mind

All GeneralAire products are backed by the best limited warranty in the industry, for your peace of mind.

You benefit from a lifetime warranty on the core, a 10-year warranty (5 years + 5 years prorated) on our ventilation motors, a 5-year warranty on the enthalpic core, and a 5-year warranty on all other components. So you can breathe easy.

About Us

GeneralAire offers you a complete range of products designed to improve indoor air quality, and that provides a wide selection of accessories to facilitate installation.

Our vision – To offer a complete range of GeneralAire products that satisfy environmental concerns.

Whether your needs involve ventilation, purification, humidification or filtration, GeneralAire has the customized solution for you, with its range of quality products backed by the best warranty in the industry.

Installation

INFORMATION FOR INSTALLERS	PAGE
1. Ventilation needs	3
2. Types of installation	3
3. GeneralAire HRV/ERV systems	6
4. Finding a suitable installation area for the HRV or ERV	6
5. Installation of the HRV/ERV	7
6. Rigid duct	7
7. Insulated flex from unit to outside wall	8
8. Condensation drain line	9
9. Devoted electric receptacle	10
10. Outside fresh air and exhaust air hoods	11
11. Fresh air and exhaust air grilles	12
12. Benefits of the Duotrol™ system	13
13. Balancing the unit	14

Functions and Controls

INFORMATION FOR HOME OWNERS AND INSTALLERS	PAGE
14. Controls and wiring	15

Technical Information

INFORMATION FOR HOME OWNERS AND INSTALLERS	PAGE
15. Troubleshooting	19
16. Wiring diagram	20
17. Maintenance	21
18. Specification and technical information	22

1. Ventilation Needs

Determine your ventilation needs installation

How much fresh air do I need? Good air quality is based in part on the capacity of the home's ventilation system.

Usually, the HRV's or ERV's capacity is measured in CFM (cubic feet per minute) or L/s (Liters per seconds) of fresh air being distributed in the living space. The room count calculation or the air change per hour method shows you how to determine your ventilation needs.

Independent system installation



This application uses a devoted duct system for the supply and the exhausting of stale air accumulated in the home.

It is recommended to install fresh air grilles in all bedrooms and living areas. Exhaust the stale air from the bathroom, kitchen and laundry room.

A. Room count calculation

LIVING SPACE	Number of Rooms	CFM (L/s)	CFM Required
Master Bedroom	_____	x 20 cfm (10 L/s)=	_____
With Basement	_____	x 20 cfm (10 L/s)=	_____
Without Basement	_____		_____
Single Bedroom	_____	x 10 cfm (5 L/s)=	_____
Living Room	_____	x 10 cfm (5 L/s)=	_____
Dinning Room	_____	x 10 cfm (5 L/s)=	_____
Family Room	_____	x 10 cfm (5 L/s)=	_____
Recreation Room	_____	x 10 cfm (5 L/s)=	_____
Other	_____		_____
<hr/>			
Kitchen	_____	x 10 cfm (5 L/s)=	_____
Bathroom	_____	x 10 cfm (5 L/s)=	_____
Laundry Room	_____	x 10 cfm (5 L/s)=	_____
Utility Room	_____	x 10 cfm (5 L/s)=	_____

TOTAL ventilation requirement (add last column)=

1 CFM = 0.47189 L/s
1 L/s = 3.6 m³/hr

B. Air change per hour method

TOTAL cu ft x 0.35 per hr = total

Take total and divide by 60 to get CFM

Example: 25' x 40' house with basement
 1,000 sq. ft. x 8' high x 2 (1st floor + basement) = 16,000 cu. ft.
 16,000 cu. ft. x 0.35 ACH = 5,600 cu. ft.
 5,600 cu. ft./60 minutes = 93 CFM
93 CFM is your ventilation need

2. Types of Installation

Independent System

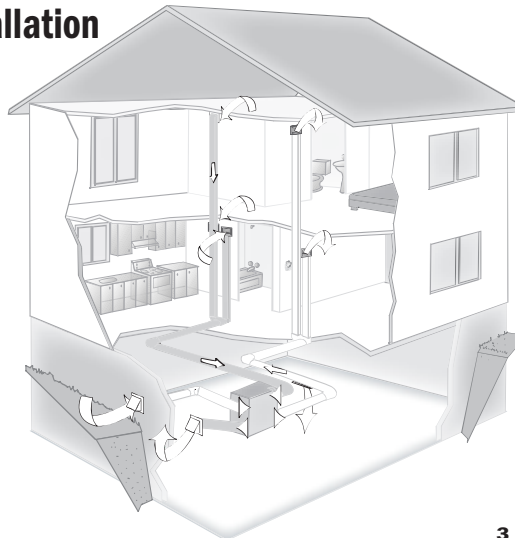

2. Types of Installation (continued)



Exhaust at the source and supply in the return installation

This application uses a devoted duct system for the exhausting of stale air accumulated in the home. The fresh air is dumped into the return air duct and is distributed thru the home by the existing supply air ductwork of the forced air system.

Make sure when using this application that your fresh air duct connection to the forced air system return air duct is at least 3' from the forced air system. You should check with your local code or the forced air system's manufacturer.

There are different practices used to combine HRV or ERV to a forced air system.

Exhaust at the source

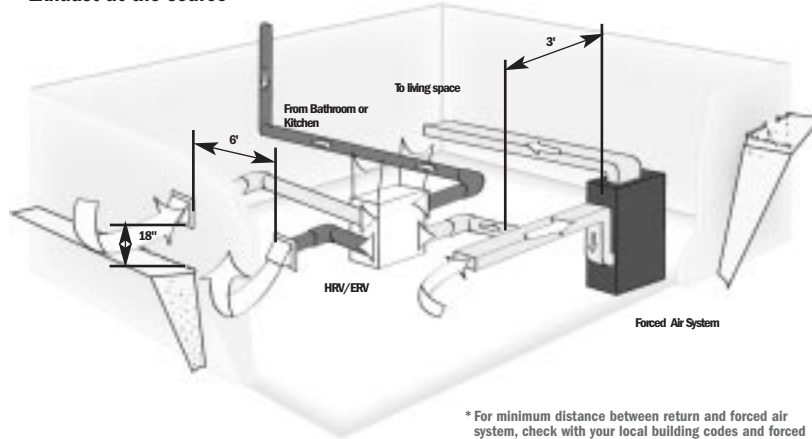

* For minimum distance between return and forced air system, check with your local building codes and forced air system manufacturer.

Indirect Connection - Breathing Tee

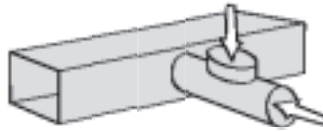

A Breathing Tee is a ventilation air supply duct with an open tee located before the connection to the return air duct. It allows the HRV to function without supply air flow rates being affected by the forced air system's fan speed.

Leaving a gap in the ventilation air supply duct in place of the breather tee is acceptable but not recommended.

Indirect Connection - Return Air Grille

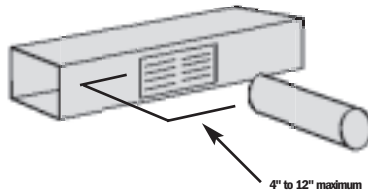

With the return air grille approach, HRV or ERV ventilation supply air is "dumped" near a grille (between 4" and 12") in the return air duct upstream of the recirculation fan.

*See your local code before making an installation.

2. Types of installation (continued)

Exhaust and supply in the return installation



When using this application make sure that there is at least 6' between the fresh air and exhaust air connections of the HRV or ERV in the return air duct.

Supply air from HRV or ERV must be at least 3' from the forced air system. Can be different from a region to an other. You should check with your local code or the forced air system's manufacturer.

Note to installer

Fresh air must always be down-stream from the exhaust air in the return air duct of the forced air system.

Exhaust from the return and supply in supply installation

When using this application make sure that the Supply air from HRV or ERV is at least 3' from the forced air system. Can be different from a region to an other. You should check with your local code or the forced air system's manufacturer.

Exhaust and supply in the return

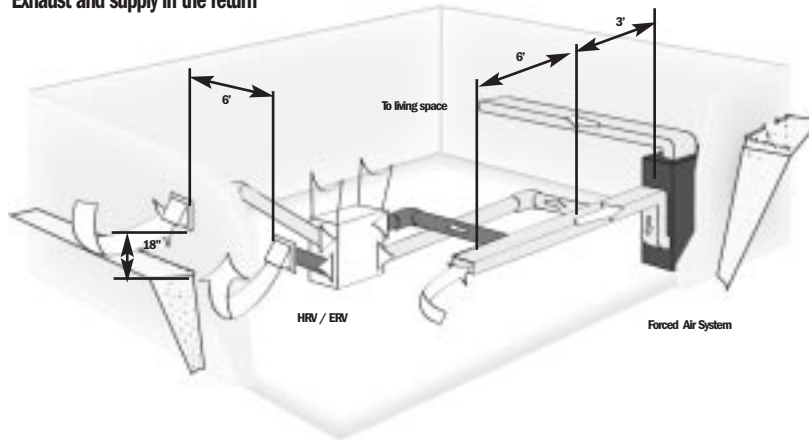

Simplified Connection

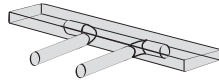

FOR MINIMUM DISTANCE BETWEEN RETURN AND FORCED AIR SYSTEM
Check with your local building codes and force air system manufacturer.

Exhaust from return and supply in supply

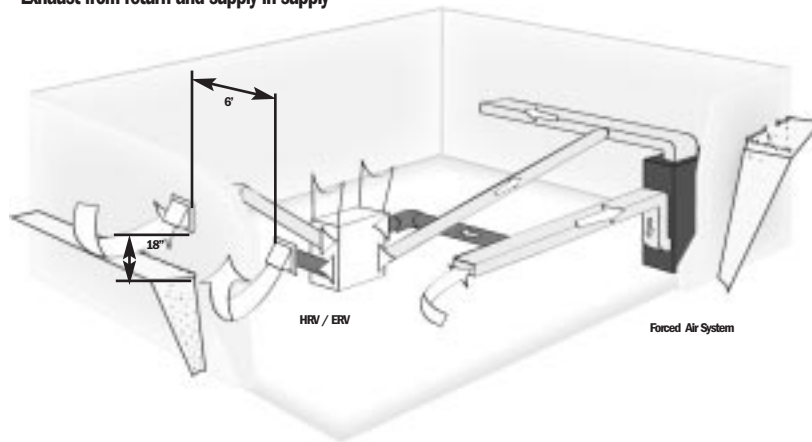

3. GeneralAire HRV/ERV systems

Installation Kit

Included in the installation kit:

- 4 Collars
- 2 Flexible Vinyl Ducts
- 1 Condensation Drain Line
- 1 Drain Adapter with Nut
- 4 Tie Wraps (30")
- 16 screws (#10 x 5/8")
- 4 screws (#10 x 1")
- 4 Washers

TIPS

to installer

Removing the core unit will facilitate your job.



Figure 3.1 Pull out the inserts first then use the straps to lift the unit out of the box.

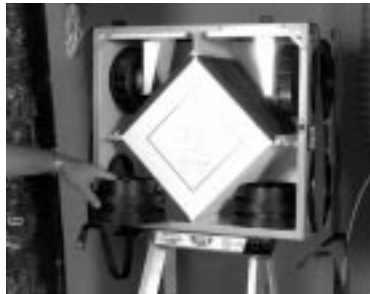

Figure 3.2 Installation kit is shipped inside the unit.



Figure 3.3 Installation kit.

4. Finding a suitable installation area for HRV or ERV

The HRV or ERV units should be installed in a mechanical room or as close to an outside wall as possible. This would assure a short run of insulated flexible duct.

The HRV or ERV unit must always be installed in an area where the air is tempered to avoid freezing of the condensate line. The contractor should install the unit in area that is very accessible to allow the homeowner easy access for maintenance.

It is very important to install an electric receptacle (115v) near the HRV or ERV, a separate circuit breaker is also recommended. You should have access to a condensate drain near the HRV or ERV to avoid the use of condensate pump.

5. Installation of the HRV/ERV

The SPM™ system is supplied with the HRV or ERV to allow one person mounting of unit.

SPM™ attachment system



The entire line of GeneralAire HRV/ERV products is designed for installation by a single person. "Single Person Mounting™" will enable you to save time and effort by offering you a variable attachment system and maximizing your basement space.

TIPS to installer

If unit is not level, improper drainage will occur and could lead to moisture and leakage problems.

TIPS to installer

It is recommended to use approximately 16" of flexible duct (supplied in kit) between the HRV or ERV and your rigid duct (see figure 6.1). The flex duct is mounted the same way to the HRV or ERV as the insulated flex close on step 6 (see figure 6.2).



figure 5.1 Place HRV/ERV on a stepladder.



figure 5.2 Attach your four straps to the floor joist making sure that you attach thru the washers and the grommets.



figure 5.3 Pull on the middle strap and gently push upward on the unit. Then repeat procedure on other side.



figure 5.4 When completing the procedure make sure that the HRV or ERV is leveled.

6. Rigid duct



figure 6.1 Mount flex to HRV/ERV.



figure 6.2 Mount flex to rigid duct.

7. Insulated Flex from Unit to Outside Wall.



ISF™ collar system (Patent Pending Technologies)

Quick and simple to install thanks to our revolutionary "Insert Slide and Fix™" collar system.

The "ISF™" collar system enables you to manipulate duct within your reach and then insert the collar to the HRV/ERV by sliding it in place, for a better and quicker installation.

TIPS to installer

To ensure a better installation and to avoid an undesired bend in the duct, align the duct with the collar before securing over the four hooks.



figure 7.1 ISF™ collar system - removable part.

The installer can now benefit from the ISF™ collar system for its flex duct installation to the unit. Take four collars out of the unit. Insert the flex over the interior flange of the collar. Make sure that flex is pushed all the way, so the four tabs on the collar hook on to the flex. Seal with tie wrap (4 tie wraps supplied with unit). Pull insulation over the interior flange. Pull vapor barrier over outer flange on the collar and seal with duct tape.



figure 7.2 Insert vinyl duct over the hooks and seal with a 30" tie wrap.



figure 7.3 Insert insulation inside the collar.



figure 7.4 Finish by taping the duct on the collar.

Once insulated flex is attached to the collar, slide collar in keeper section, fixed collar to the unit with four screws supplied in installation kit.

Insert the threaded drain adapter thru the bottom of the HRV or ERV and hand tighten the plastic nut supplied with the drain kit.



figure 7.5 Slide collar on the unit.

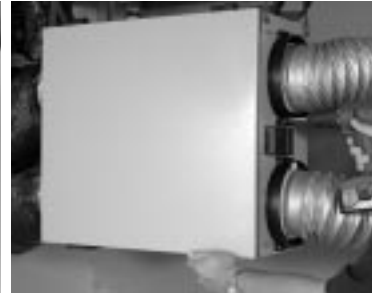

figure 7.6 Fix and secure with two screws supplied.

8. Condensation Drain Line



Sloped Drain Pan drainage system

GeneralAire HRV/ERV units are equipped with an easy-access sloped drain pan.

Excess condensation that might accumulate inside the unit migrate to the centre of the drain pan to be evacuated.



figure 8.1 Hand screw the drain adapter

Insert the threaded drain adapter thru the bottom of the HRV or ERV and hand tighten the plastic nut supplied with the drain kit.

Install the condensate line (10 feet included in drain kit). Insert condensate tubing by pushing clear plastic line over drain adapter. Make condensate trap by looping the clear plastic tubing. This procedure is to avoid foul odor to enter the HRV or ERV.



figure 8.2 Insert condensate line.



figure 8.3 Make a loop in condensate line.



figure 8.4 Use a condensate pump if you don't have access to the floor drain.

9. Devoted Electric Receptacle



figure 9.1 HRV/ERV's Power Cord

Insert the power cord on top of the unit. Press firmly to make sure the power cord is secure.



figure 9.2 Electric Wall Outlet

It is recommended that the HRV or ERV have a devoted receptacle with 115v. It is not recommended to connect unit with an extension cord. If no receptacle is available please call an electrical contractor and have one installed.

10. Outside Fresh Air and Exhaust Air Hoods

TIPS

to installer

To make your installation easier use our double collar to install your flex pipe with the outside hoods (figure 12.2).

TIPS

to installer

We manufacture a wide selection of:

- Insulated flexpipe
- Hoods

TIPS

to installer

Extend the sheet metal sleeve 1.5" inside the home. Attach GeneralAire specialty ISF™ collar to sheet metal sleeve.



figure 10.1 Locating outside hoods.



figure 10.2
Insert vinyl duct over the hooks. Fix the collar on the floor joist.



figure 10.3
Insert insulation inside the collar and finish by taping the vapor barrier on the collar.



figure 10.4 Install outside hoods.

11. Fresh Air and Exhaust Air Grilles

TIPS to installer

Note: It is not recommended to exhaust your clothes dryer, your kitchen exhaust hood or your central vacuum cleaner thru your ventilation system.

Save Time and Space...

with GeneralAire's Stack Head Elbow available to fit your needs. Ask your local distributor for more information on our full range of accessories.

We manufacture a wide selection of:

- Duct
- Stack Head Elbow
- Grilles



figure 11.1 Grille.

It is recommended to install fresh air grilles in all bedrooms and living areas. The exhaust air grilles should be located in the bathrooms, kitchen, laundry room and storage room. Grilles are usually installed 12" from the ceiling.

GeneralAire grilles are recommended for quiet air diffusion (4, 5, 6 and 8 inches are offered).

The grilles combined with our GeneralAire 4" space saving grille adapters (stack head elbow) makes for easy and time saving installation.



figure 11.2 Stack head elbow.



figure 11.3 Insert grille.

It is recommended to exhaust the stale air from the bathroom, kitchen, laundry room and storage room. These areas have been found to be the most pollutant areas in a home.

For the kitchen we recommend the use of GeneralAire's grease filter grilles.

12. Benefits of the Duotrol™ System

Duotrol™ balancing system (Patent Pending Technologies)



Silent and economical... By reducing motor speed to balance the unit, you avoid the noise that would be produced by balancing dampers.

In addition, with this technology the unit will consume less energy.



figure 12.1 Duotrol™ System

GeneralAire's Duotrol™ balancing system (patent pending) is state of the art technology simplified for quick and easy installation for the contractor's peace of mind. The Duotrol™ serves two purposes.

Acts as a mode selector

Intermittent: When the selector switch is in the intermittent position the HRV or ERV will only run when there is a call for ventilation by any control. At that time the unit will run on high speed until the condition is satisfied.

Continuous: When the selector switch is in the continuous position the HRV or ERV will run continuously on low speed except when there is a call for override by any control.

Off: When the selector switch is in the off position the HRV or ERV will not come on even if there's a call for ventilation by any control.

Mode selector

- Intermittent
- Continuous
- Off



Acts as a balancing control (see instructions)

The Duotrol™ lets contractor set speed of the motors for balancing purposes (Exhaust air, Fresh air and Both motors).

INTER.: Selects the exhaust air motor

CONT.: Selects both exhaust and fresh air motors

OFF: Selects the fresh air motor

Balancing control

- Intermittent
- Continuous
- Off



+ Button: Increase the speed of the selected motor.

- Button: Decrease the speed of the selected motor.

- Increase Speed
- Decrease Speed



13. Balancing the unit

TIPS

to installer

As mentioned in the section, the DuoTrol™ System has two different purposes.

1. Mode Selector
2. Balancing Mode

The light indicator shows you in which mode the DuoTrol™ System is in.

 **GREEN LIGHT**
Mode Selector

 **YELLOW LIGHT**
Balancing Mode



figure 13.1 DuoTrol™ System

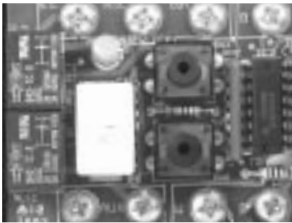

figure 15.6 Selector Switch

Using the Selector Switch to installer

When on Balancing Mode, the Selector Switch allows you to choose the motor you want to set.

Closed DuoTrol Cover

1. INTER (Exhaust Motor)
2. CONT (Both Motors)
3. OFF (Supply Motor)

or

Open DuoTrol Cover

1. UP (Exhaust Motor)
2. MIDDLE (Both Motors)
3. DOWN (Supply Motor)



figure 13.2 Magnehelic Gauge with Air Flow Grid



figure 13.3 Magnehelic Gauge with Air Flow Grid



figure 13.4 Inserting Air flow grid in duct



figure 13.5 Seal Air flow grid in duct with duct tape.

Step 1: Press the (+) and (-) buttons simultaneously until you see the yellow light. Once the indicator light turns yellow you are in balancing mode.

Step 2: When in balancing mode the selector switch becomes the motor selector switch. INTER (Right Motor), CONT (Both Motors) and OFF (Left Motor)

Step 3: Once the total cfm needed is determined, you can start balancing the HRV/ERV. Set your fresh air supply by selecting the "OFF" position on the DuoTrol™. Install your magnehelic gauge and air flow grid in the fresh air duct.

Step 4: Press the (-) button to decrease the cfm or press the (+) button to increase the CFM.

Step 5: Then perform the same operation on the stale air side by selecting the "INTER" position on the DuoTrol™.

Step 6: The "CONT" position will allow you to adjust the cfm on both motors proportionately (if necessary).

Step 7: Once this is completed, you have set the high speed on your HRV/ERV. To lock balancing mode you must press (+) and (-) buttons simultaneously and release. The indicator light will turn green to indicate normal operation mode.

Step 8: Once high speed is set and locked, switch to continuous on the DuoTrol™. By using (+) and (-) buttons set low speed on the HRV/ERV.

Step 9: Select the mode of operation. (Intermittent, Recirculation or Continuous Ventilation)

14. Controls and Wiring

Range of controls



The entire range of GreenThinker™ model controls is offered with features making your ventilation system simple, easy to operate and backed by a 5-year limited warranty.



RD-I model™
DEHUMIDISTAT

Features

- Dehumidistat to select the humidity level

GeneralAire's RD-I model™ allows the homeowner control of the indoor humidity level. RD-I model™ is compatible with the P, F and SHM models™.

The RD-I model™ is a two wires connection. On the Duotrol™ System and the RD-I model™ use R and G terminal connections on the lower right hand side of the control board.



figure 14.1 RD-I model™

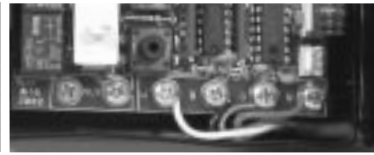

figure 14.2 Duotrol™



RD-II model™
DEHUMIDISTAT

Features

- Dehumidistat to select the humidity level
- Speed Control (Off, Normal and Reduced)
- Light On Override

GeneralAire's RD-II model™ allows the homeowner control of the indoor humidity level by selecting the humidity percentage and fan range (off, normal and reduced).

RANGE		
RANGE OFF NORMAL REDUCED	OFF : NORMAL : REDUCED :	This function allows the HRV or ERV to be shut off by the remote dehumidistat. This function allows the HRV or ERV to operate on balanced low speed. This function allows the HRV or ERV to operate on lower speed, continuous and override.
DEMAND		
	Light indicator	Shows homeowner when HRV or ERV is on override by switching on a display light on the remote dehumidistat or any other control.



figure 14.3 RD-II model™



figure 14.4 Duotrol™

14. Controls and Wiring (continued)



RD-III model™
DEHUMIDISTAT PROFESSIONAL

Features

- Dehumidistat to select the humidity level
- Speed Control (Off, Normal and Reduced)
- Mode Control (Intermittent and Continuous Ventilation)
- Light On Override

GeneralAire's RD-III model™ allows the homeowner control of the indoor humidity level by offering three selections of operation. The controller allows the homeowner to select humidity percentage, fan speed and operation mode.

MODE		Allows the homeowner to select intermittent or continuous on the Professional model and recalculation on the Deluxe model.
<div style="border: 1px solid black; padding: 2px; display: inline-block; text-align: center;"> MODE INTERM RECIRC CONT </div>	Intermittent:	Allows HRV or ERV to run only when there is a call for ventilation.
	Recirculation:	Allows HRV or ERV to run continuously on low speed.
	Continuous:	* See RD-1 and RD-2 for other functions



figure 14.5 RD-III model™

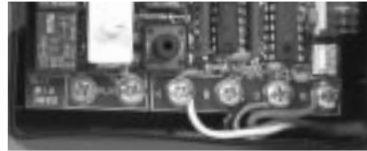

figure 14.6 Duotrol™

The above controller have four wires connection. On the Duotrol™ System and RD-III model™ use R, G, B and W terminal connections on the lower right hand side of the control board.

GeneralAire's RD-IV model™ allows the homeowner control of the indoor humidity level by offering four selections of operation. The controller allows the homeowner to select the humidity percentage, fan speed, operation mode and cycles per hour.

14. Controls and Wiring (continued)



RD-IV model™
DEHUMIDISTAT PROFESSIONAL

Features

- Dehumidistat to select the humidity level
- Speed Control (Off, Normal and Reduced)
- Mode Control (Intermittent and Continuous Ventilation)
- Cycles per hour (0/0, 20/40 and 30/30)
- Light On Override
- Maintenance Light Reminder

GeneralAire's RD-IV model™ allows the homeowner control of the indoor humidity level by offering four selections of operation. The controller allows the homeowner to select the humidity percentage, fan speed, operation mode and cycles per hour.

CYCLES		Allows the homeowner to select cycles per hour
CYCLES / HOUR 	0	Normal operation mode
	20/40	20 minutes on high speed and 40 minutes on previously set mode of operation
	30/30	30 minutes on high speed and 30 minutes on previously set mode of operation
MAINTENANCE		
	Light indicator:	Shows homeowner when HRV or ERV needs to be maintain.

* See RD-1 and RD-2 for other functions

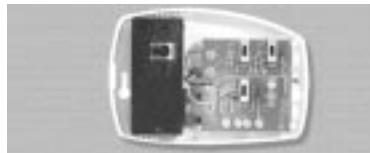

figure 14.7 RD-4P and RD-4D model™



figure 14.8 Duotrol™

The above controller have four wires connection. On the Duotrol™ System and RD-IV model™ use R, G, B and W terminal connections on the lower right hand side of the control board.

14. Controls and Wiring (continued)



T-Vmodel™
PUSH-BUTTON TIMER

Feature
· 20/40/60 minutes exchange

GeneralAire's **Vmodel™** allows the homeowner controls of the indoor humidity level in rooms where more humidity is produced (Ex. bathroom and kitchen).

The **Vmodel™** allows the homeowner to override the RD model™ to high speed for a determined length of time (20min, 40min and 60min).

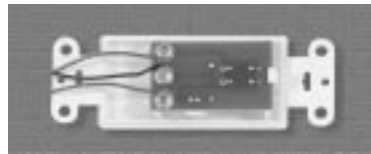
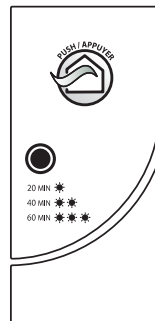

figure 14.9 Vmodel™



figure 14.10 Duotrol™

The **Vmodel™** is a three wires connection. On the low voltage control board use R, G and B terminal connection on the top right hand corner of the board.



To operate:

Press the PUSH button once, the light indicator will blink one time. The unit will operate at high speed for 20 minutes.

Press the indicator light until it blinks twice, the unit will operate at high speed for 40 minutes.

Press the indicator light until it blinks 3 times, the unit will operate at high speed for 60 minutes.

(Pressing the button gives you the first blink.)

15. Troubleshooting



Peace of Mind

Ensure your comfort in the years to come by using GeneralAire systems and accessories to install any ventilation, humidification, purification or filtration product.

Need help? You benefit from certified customer service ready to guide you in the installation or operation of your GeneralAire system.

Call: **1-248-476-5100**

PROBLEMS	SOLUTIONS
<ul style="list-style-type: none"> • HRV or ERV not running 	<ul style="list-style-type: none"> • Verify breaker in electrical box • Verify that dehumidistat or switch on HRV or ERV are activated to supply power to unit. • Unplug HRV or ERV verify if controller is wired correctly to the connection box on the side of the unit. • Verify low voltage box (Duotrol™) on the unit
<ul style="list-style-type: none"> • Air is too dry 	<ul style="list-style-type: none"> • Increase humidity level on dehumidistat. • Switch ventilation mode from continuous to intermittent • Install a GeneralAire humidifier
<ul style="list-style-type: none"> • Air too humid 	<ul style="list-style-type: none"> • Reduce the humidity level on the controller. • Verify if dryer is venting in basement. • Verify if heating wood is stored in basement. • Wait for outside temperature to change. Ex. Summer can be extremely humid. • Verify balancing of the HRV or ERV.

16. Wiring Diagram



Standard Forced Air Interlocking Wiring

A relay is normally used when tying a ventilation system onto forced air distribution system. Our Duotrol System is equipped with an internal relay that will activate the forced air system ventilator when there is a demand from the HRV/ERV. The Duotrol System will activate the INTERLOCK relay during the following modes: Continuous, Override, Recirculation and Defrost. See wiring diagram.

Standard Forced Air Interlock Wiring

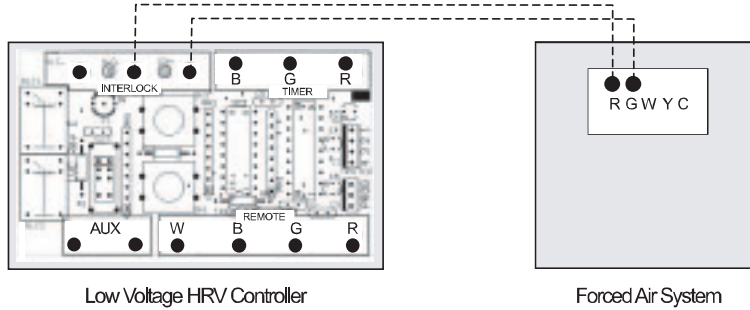

Legend:

----- Field Installed Low Voltage

Alternate Forced Air Interlocking Wiring

Some forced air system thermostat will activate the cooling system when tied using the "Standard forced air interlocking wiring".

If you have identify this type of thermostat you must proceed with the "Alternate forced air wiring".

Alternate Forced Air Interlock Wiring

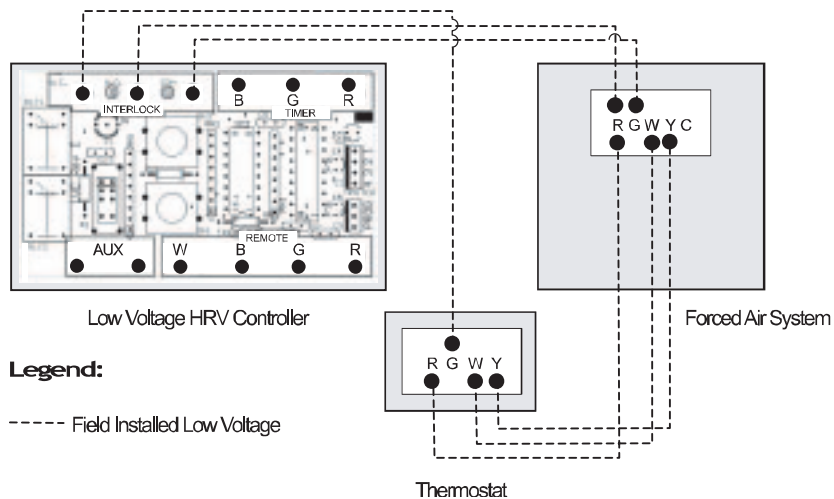

Legend:

----- Field Installed Low Voltage

Locating the Wiring Diagram

to installer

Wiring diagram for the entire line of professional and furnace models are placed on the back of each exhaust motor bracket.

*Before tying the HRV/ERV to a forced air system, always refer to system's manual or manufacturer.

17. Maintenance

FMA™ maintenance system



In order to improve air quality and offer the best possible air quality in your home, GeneralAire has developed one of the first maintenance service systems in the industry. The "Filter Maintenance Adviser™" will remind you by e-mail when the filter of your HRV/ERV system must be replaced, to maximize its performance and efficiency.

For more information call:
1-248-476-5100

When should I Service my HRV/ERV?

service and accessories



HEAT RECOVERY CORE UNIT

Once a year or as needed, vacuum the four surfaces, let soak in warm water for three hours, then spray rinse and let dry.

FILTERS

Four times a year or as needed, vacuum the filters. Replace filters once a year.

INSIDE THE UNIT

Once a year or as needed, clean the interior of the unit (walls and drain pan) with a mild and non abrasive soap. It is recommended to use products that are environmentally-friendly.

ENERGY RECOVERY CORE UNIT

Once a year or as needed, vacuum the four surfaces.

Note

to installer

IMPORTANT : ALWAYS UNPLUG HRV OR ERV DURING SERVICING

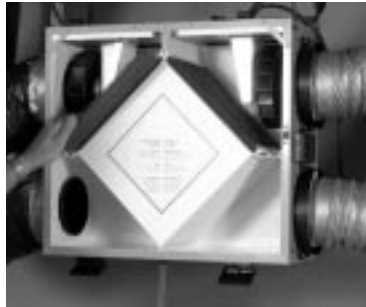

figure 17.1 Slide Out the Filters



figure 17.2 Vacuum the Filters

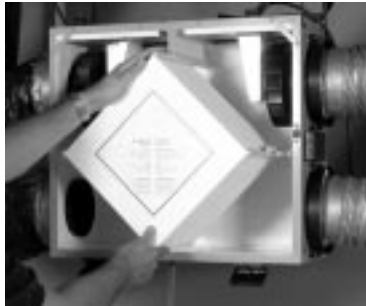

figure 17.3 Slide out the Energy Core



figure 17.4 Wash the Walls of the Unit

18. Specification and Technical Information

Easy Access Door removable top hinge door

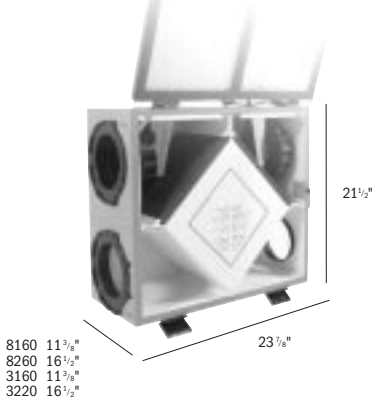

SPECIFICATIONS	8160	8220
Size	23 ^{7/8} " x 21 ^{1/2} " x 11 ^{3/8} "	23 ^{7/8} " x 21 ^{1/2} " x 16 ^{1/2} "
Heat exchanger (L x H x W)	12" x 12" x 10"	12" x 12" x 15"
CFM	30 to 160	50 to 220
Type of heat exchanger	cross-flow	cross-flow
Exchange surface	104 ft ²	150 ft ²
Power consumption	130 W	150 W
Defrost type	Exhaust	Exhaust
Certification	HVI, cCSA _{US}	HVI, cCSA _{US}

SPECIFICATIONS	3160	3220
Size	23 ^{7/8} " x 21 ^{1/2} " x 11 ^{3/8} "	23 ^{7/8} " x 21 ^{1/2} " x 16 ^{1/2} "
Heat exchanger (L x H x W)	12" x 12" x 10"	12" x 12" x 15"
CFM	30 to 160	50 to 220
Type of heat exchanger	cross-flow	cross-flow
Exchange surface	104 ft ²	150 ft ²
Power consumption	130 W	150 W
Defrost type	Exhaust	Exhaust
Certification	cCSA _{US}	cCSA _{US}

Note to installer

All GeneralAire products are backed by the best limited warranty on the market.

GeneralAire reserves the right to modify a product, without prior notice, whether in design, colour or specifications, in order to offer at all times a quality product that is highly competitive.

Please consult local authorities to find out whether the installation of electrical products requires the services of a certified technician or electrician.

Certified Products and Proud Member of These Associations

