

This Owner's Manual is provided and hosted by [Appliance Factory Parts](http://Appliance Factory Parts).



# LG 88120 Owner's Manual

[Shop genuine replacement parts for LG 88120](#)

## DOOR PARTS

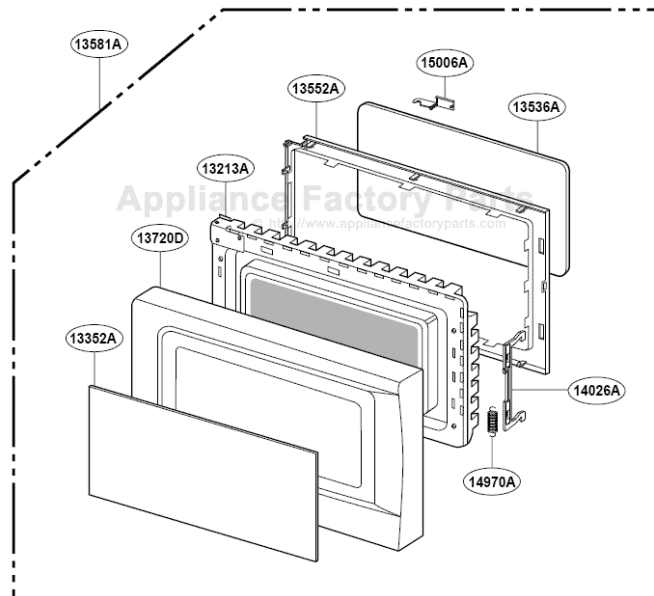

[Find Your LG Microwave Parts - Select From 955 Models](#)

----- Manual continues below -----

# EXPLODED VIEW

## INTRODUCTION

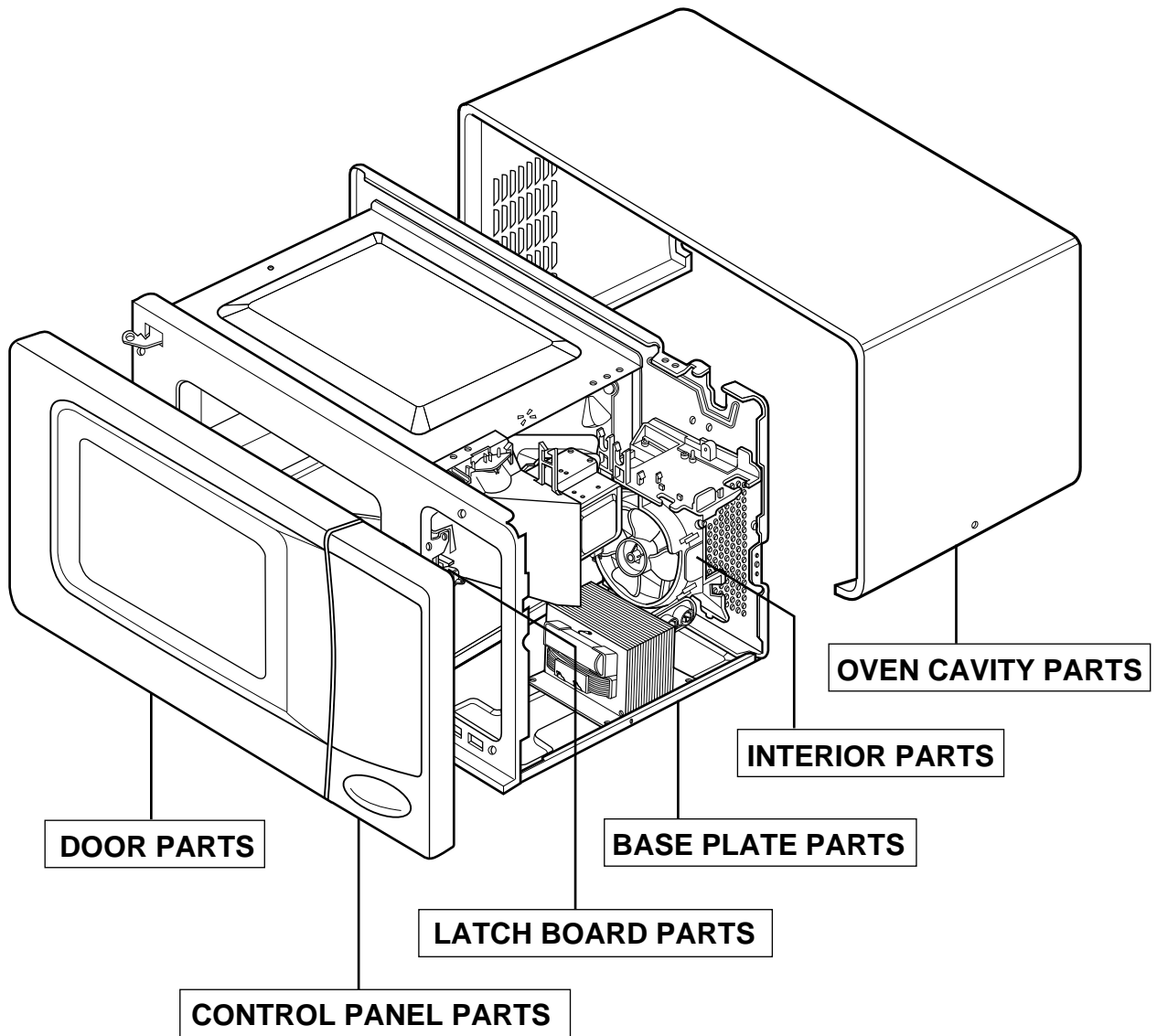

# DOOR PARTS

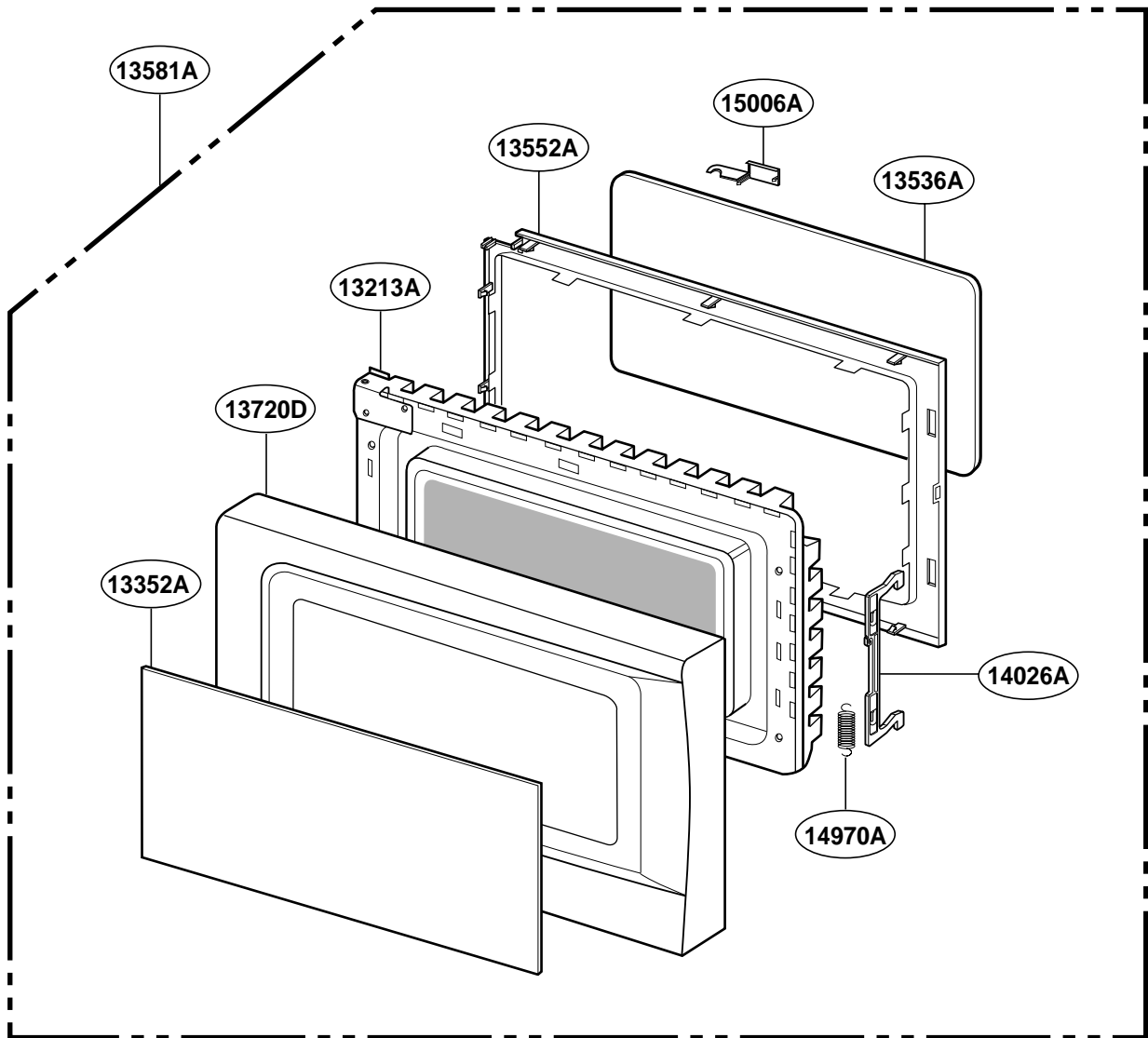

# CONTROLLER PARTS

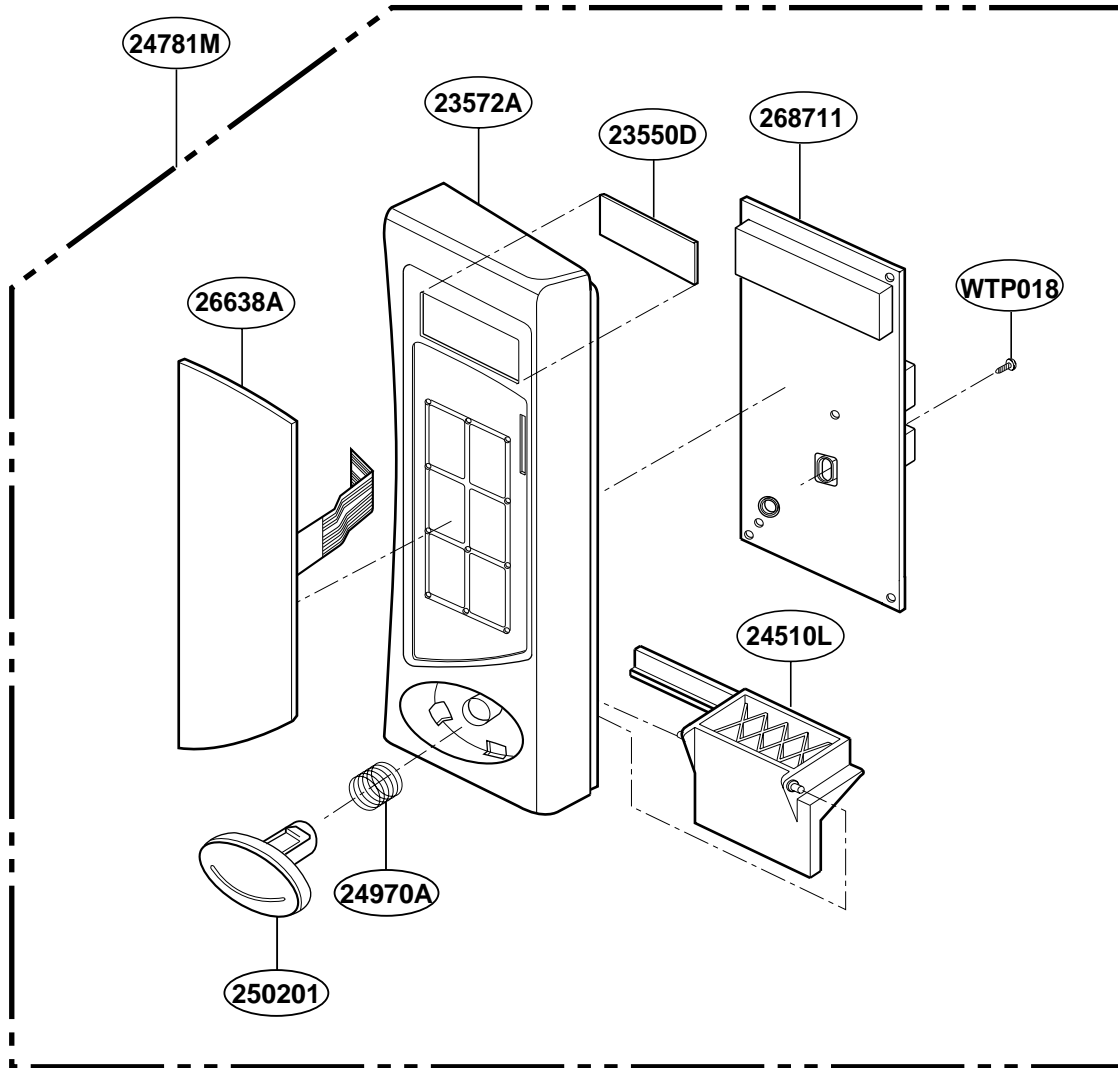

# OVEN CAVITY PARTS

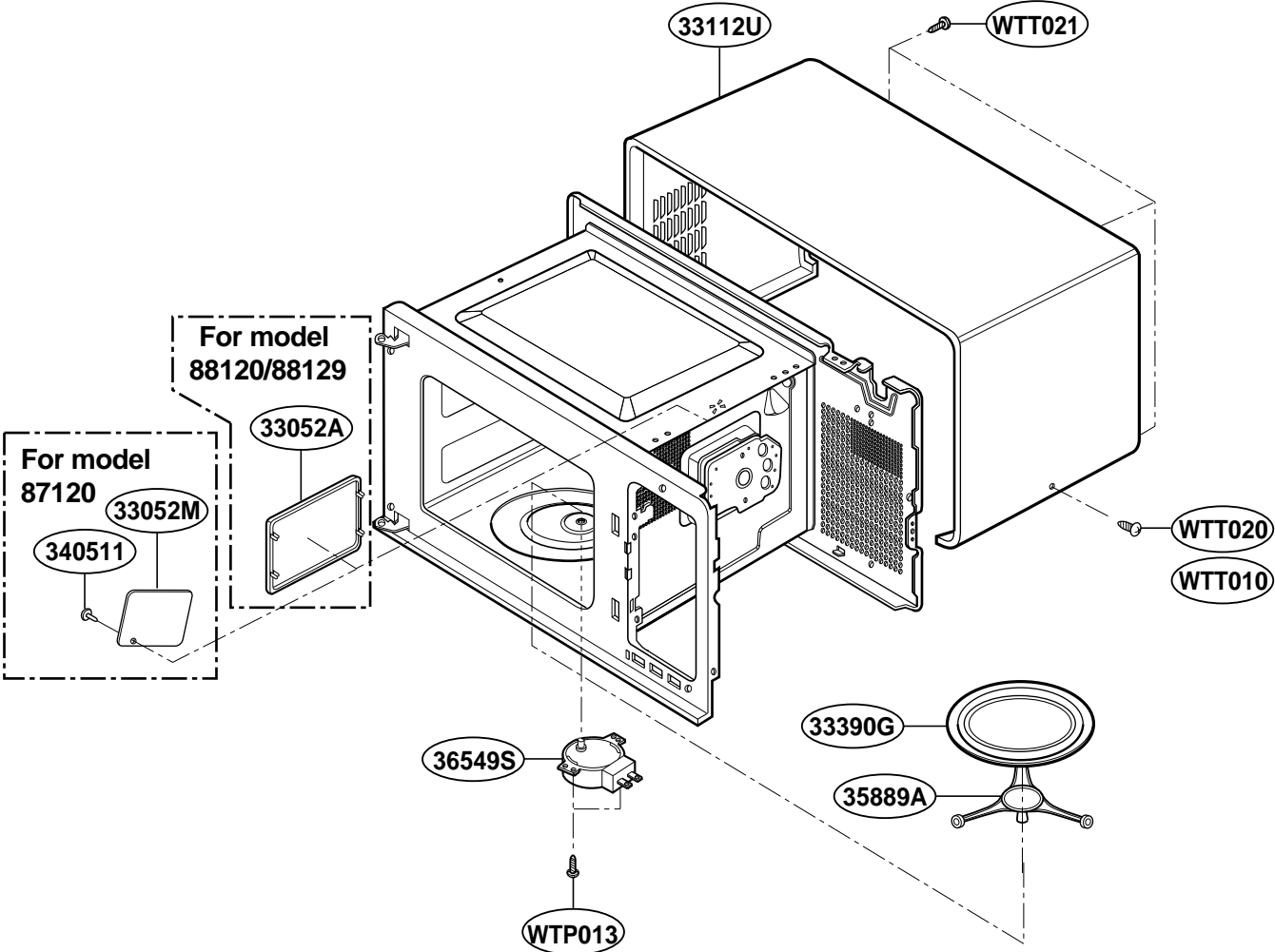

# LATCH BOARD PARTS

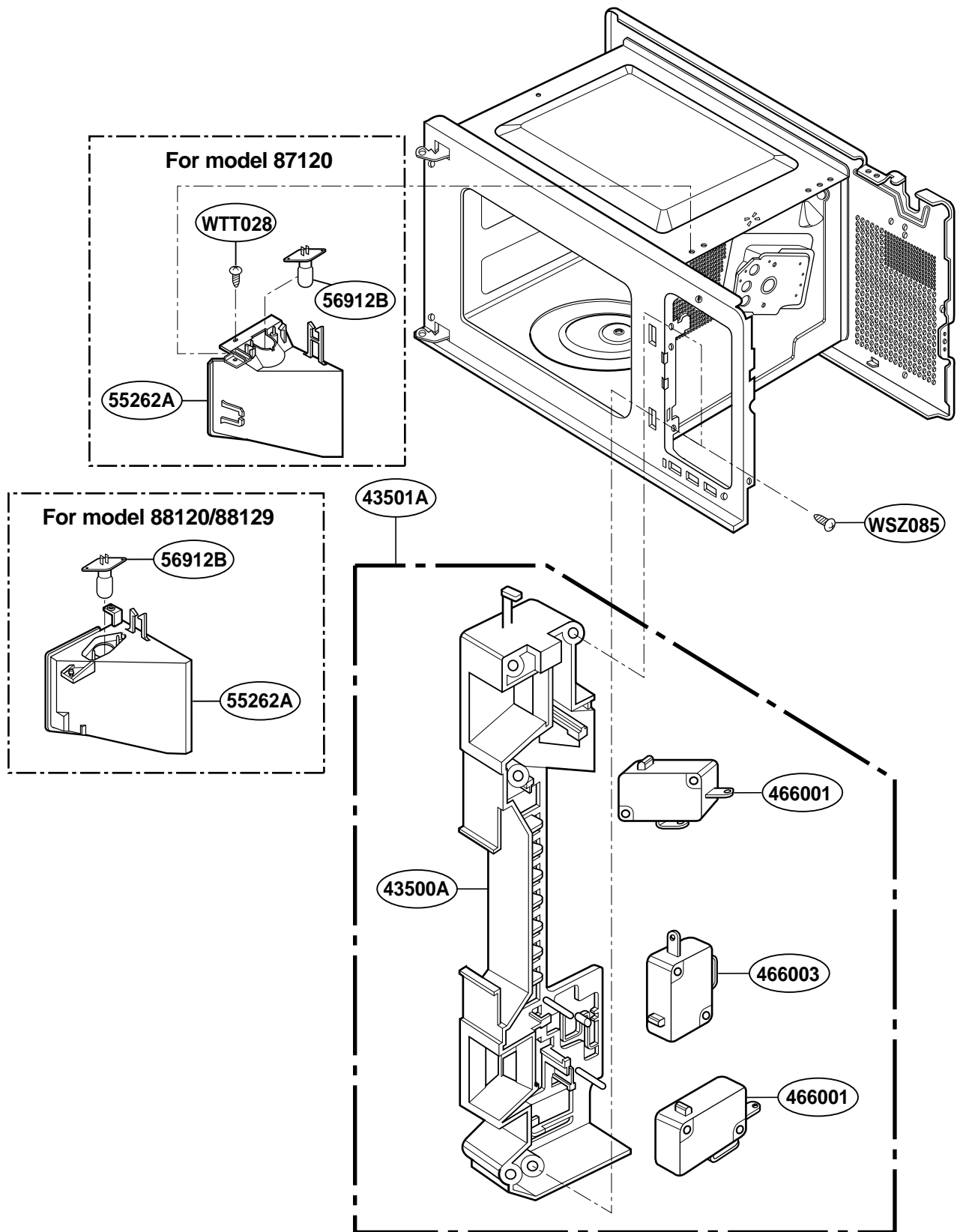

# INTERIOR PARTS

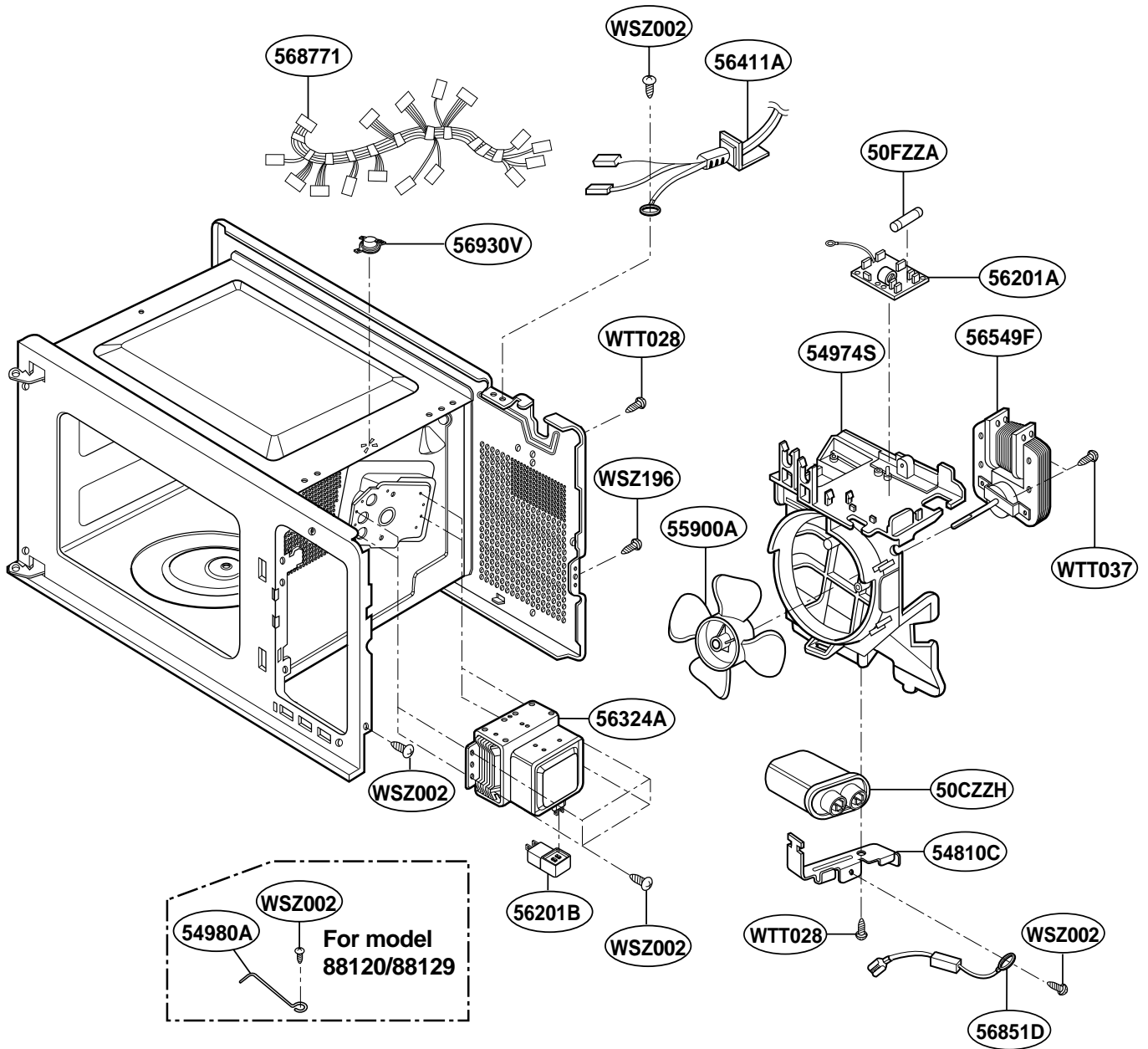

# BASE PLATE PARTS

