

**CAUTION:** Read all instructions carefully before installation.  
Save this Owner's Manual for future reference.



**Model No.  
HD1305 0**

**EMERSON<sup>®</sup>**

***MoistAIR™* HD1305  
Evaporative Console  
Humidifier Owner's Manual**

## Limited Warranty

All products covered by this Owner's Manual are warranted against defects in workmanship and materials for one year from the date of sale except for motors, which are warranted for two years. This warranty does not apply to damage from accident, misuse or alteration nor where the connected voltage is more than 5% above the nameplate voltage, nor to the equipment improperly installed or wired or maintained in violation of this Owner's Manual. No other written or oral warranty applies. No employee, agent, dealer or other person is authorized to give any warranties on behalf of Emerson Electric.

The customer shall be responsible for all costs incurred in the removal or reinstallation and shipping of the product for repairs. Within the limitations of this warranty, inoperative units should be returned, freight prepaid to a local repair service center and we will repair or replace, at our option, at no charge to you with return freight paid by Emerson. It is agreed that such repair or replacement is the exclusive remedy available from Emerson Electric Co. and that **Emerson Is Not Responsible For Damages Of Any Kind, Including Incidental And Consequential Damage.** Some states or provinces do not allow the exclusion or limitation of incidental or consequential damages, so the above exclusion or limitation may not apply to you. The warranty gives you specific legal rights, and you may also have other rights which vary from state to state or province to province.

**Sales receipt required as proof of purchase for warranty claims.**

# GENERAL SAFETY INSTRUCTIONS

## Safety Signal Words

**DANGER:** means if the safety information is not followed someone **will** be seriously injured or killed.

**WARNING:** means if the safety information is not followed someone **could** be seriously injured or killed.

**CAUTION:** means if the safety information is not followed someone **may** be injured.

1. To reduce the risk of fire or shock hazard, plug humidifier directly into a 120V, A.C. electrical outlet. Do not use extension cords.
2. Keep the electric cord out of traffic areas. To reduce the risk of fire hazard, never put the electric cord under rugs, near heat registers, radiators, stoves or heaters.
3. Always unplug the humidifier before moving it, removing the fan assembly section, before cleaning, or whenever the humidifier is not in service.

4. Keep the humidifier clean.
5. Do not put foreign objects inside the humidifier.
6. Never use your humidifier while any part is missing or damaged in any manner.
7. To reduce the risk of electrical hazard or damage to humidifier, do not tilt, jolt or tip humidifier over while unit is running.
8. To reduce the risk of damage to humidifier, unplug humidifier when water bottles are empty or when the humidifier is not in use.
9. To reduce the risk of accidental electrical shock, do not touch the cord or controls with wet hands.
10. Note the warning label shown below.

**WARNING:** To reduce the risk of fire, electric shock, or injury always unplug before filling, servicing or cleaning.

# Know Your Humidifier

Control Panel Cover & Pivoting Lid  
Removed for Clarity

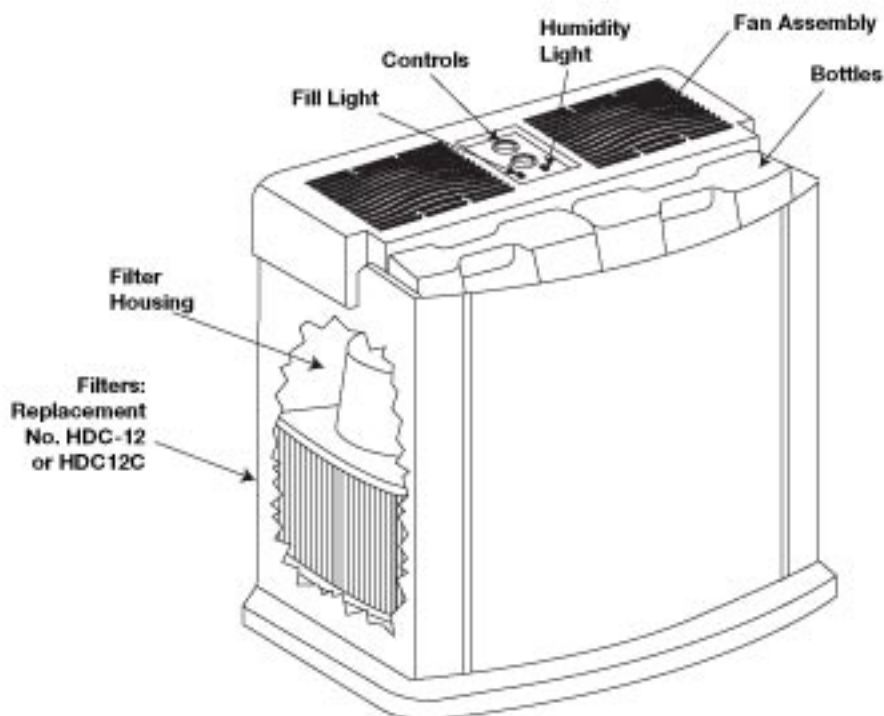

Description	HD1305
Gallon Output/24 hrs.	13
Litre Output / 24 hrs.	49
Capacity of Bottles (U.S. Gallons)	2-3/8 Gallons Each
Capacity of Bottles (Litres)	9 Litres Each
Sq. Ft. Coverage	2,700
Fan Speeds	3
Number of Filters	4 Pack (HDC-12) or (HDC12C)
Fill Light Indicator	Yes
Desired Humidity Indicator	Yes
Auto Humidistat	Yes
Auto Shut Off	Yes
Manual Dryout	Yes (See Page 7)
Controls	Rotary
CUL Listed	Yes
Volts	120 A.C.
Hertz	60
Amps	2.88
Watts	165

\* Based on an area with average insulation and an 8 foot ceiling.

## Humidifier Operations

Your new Emerson humidifier is designed to satisfy home humidity requirements through the principle of evaporation of water into the air.

After water is added to the bottles and positioned in the humidifier, the filters begin to soak up the water and become totally saturated in approximately 30 minutes. Air is drawn in from the rear of the humidifier and through the filters by means of two circulation fans. As air passes through the filters, moisture is absorbed into the air and then released through the top of the humidifier. This moist air is released in the form of vapor. No water droplets will enter the home. All evaporation into the air takes place in the humidifier, which means that the residue left by evaporating water is not passed into the home, but remains in the filter.

**CAUTION:** Use only liquid EPA Registered Bacteriostat available from your local retail store. Under no circumstances should you use water treatment products for Roto belt or Ultrasonic humidifiers.

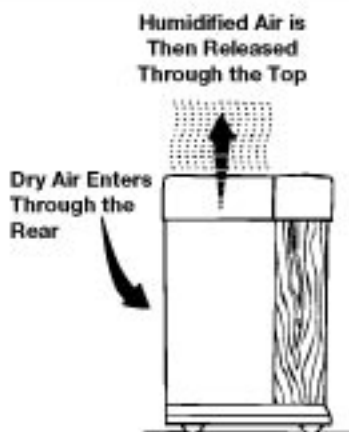

**CAUTION:** Keep your humidifier clean. While humidifiers do not cause colds, some studies suggest that dirty humidifiers can cause cold-like symptoms in some people. To avoid this, clean your humidifier weekly with cleaners specifically recommended for evaporative humidifiers.

## Unpacking & Assembly

Your new Emerson humidifier is completely assembled for you to use. Remove the bag pack containing two plastic caster pads from top of humidifier and retain for future use if required. See Step 1 on page 5 for instructions. Remove the packaging material from

inside your humidifier and follow the instructions of this owner's manual for proper usage. The packaging material is located under the fan assembly. Remove the packaging material and discard.

## Electrical Hook-Up

Locate nearest 120V A.C. wall socket in the location desired, preferably on inside wall. Plug in the electrical cord.

does not fit, contact a qualified electrician to install the proper outlet. Do not change the plug in any way.

**WARNING:** To reduce the risk of fire or shock hazard, do not use extension cords. Humidifier should be plugged directly into a 120V A.C. outlet.

To reduce the risk of electrical shock, this humidifier has a polarized plug (one blade is wider than the other). This plug will fit in a polarized outlet only one way. If the plug does not fit fully in the outlet, reverse plug. If it still

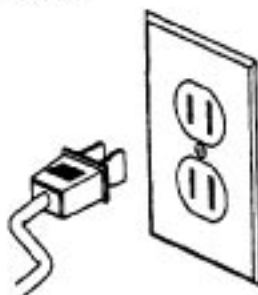

## Location Instructions

**WARNING:** For your own safety, do not use humidifier if any parts are damaged or missing.

### Step 1

Place humidifier on a flat level surface in area of house where humidity is needed most, or one which would likely result in moist air being circulated throughout the house such as near a cold air return. Placing the unit level is very important if the humidifier is located on carpeting.

**NOTE:** This console humidifier contains water bottles. The weight of the bottles in the front of the cabinet may sink the front casters deeper in the carpet. This will keep the water level float forward in the cabinet. The water level float (located at the rear of the cabinet) may not sense the water and the fill light will be on and the unit will not energize. If this happens, the unit will need to be leveled in order for the humidifier to be energized.

To level the humidifier on carpeted surfaces place the included caster pads under the front two casters of the humidifier only. Moist air (humidity) produced will disperse into the whole house, but area closest to unit will have the highest humidity. If the unit is positioned close to a window, condensation may form on the window pane. If this is not appropriate the unit should be repositioned in another location.

**NOTE:** Due to release of cool, moist air from humidifier, it is best to direct air away from home thermostat and hot air registers. It is best to position humidifier next to an inside wall. Hot air registers and cold air from outside walls can affect the efficiencies of the controls. Unit should not be placed where warm air from a hot air register blows directly on unit.

### Step 2

The humidifier should be positioned with the back (cord exit side), at least 2 inches away from the wall. Air needs to enter through louvers in the back of the cabinet in order for the humidifier to operate at peak efficiency.

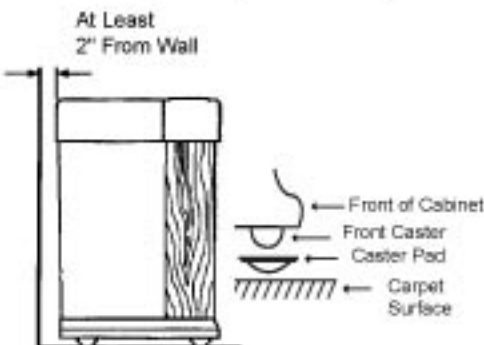

**NOTE:** If positioning on carpet, place caster pads under front casters only to level (if necessary).

## Water Fill

**WARNING:** To reduce the risk of shock, always unplug humidifier before filling, cleaning, or servicing.

**WARNING:** To reduce the risk of fire or shock hazard, do not pour or spill water into control or motor area. Close the control cover. If controls get wet, let them dry completely and have unit checked by authorized service personnel before plugging in.

This humidifier is designed to be used with the two water bottles that are located under the pivoting lid.

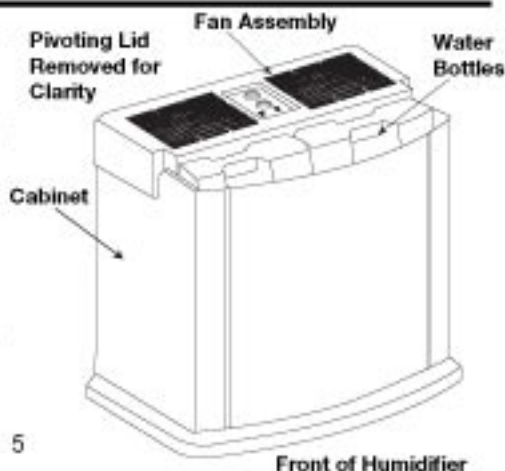

## Water Fill (continued)

Open the pivoting lid of the humidifier. Remove the water bottles, by lifting them straight up and out of the cabinet.

Notice the water bottles are designed as right and left hand units. Position them in the correct location so the humidifier can function properly. The water bottles should rest in the front of the cabinet. Each "E-Z-Fill Side-Cap" must be facing the rear of the unit.

Each water bottle is designed with an "E-Z-Fill Side-Cap" that is easily removable. Remove the "E-Z-Fill Side-Cap" on the side of the water bottle by twisting counterclockwise. Each bottle will hold 2-3/8 gallons (9 litres) of water.

Place the opening of the water bottle under a water faucet (the bottle should fit under a four-inch clearance faucet). Fill with cold water. If necessary, add recommended amount of EPA registered liquid bacteriostat. Do not add solid debris as this could make the valve leak. Install the "E-Z-Fill Side-Cap" by twisting clockwise. Hand tighten only.

**Check for possible leaks by performing the following:**

1. Grasp bottle handle and hold the bottle upright over a sink.
2. Press up on valve cap plunger for about one second to let out a little water.
3. Release the plunger.
4. Listen for air bubbles. Look for leaks around "E-Z-Fill Side-Cap".
5. If you hear air bubbles or see leaks, retighten "E-Z-Fill Side-Cap" and repeat steps 1-4.

**NOTE: Repeat for other bottle. If either fill cap leaks, water may overflow and leak out of the rear vents of the cabinet.**

Wipe off excess water from the bottle. Position the water bottle back into the unit. Grasp the water bottle handle, and lower into the cabinet until the bottle sits on pads at bottom of cabinet. The "E-Z-Fill Side-Cap" must be facing the rear of the cabinet. When positioned properly, the plunger will open and water will flow into the cabinet. The water level will automatically remain at approximately 1/2" until the bottles are empty.

The unit is now ready for operation.

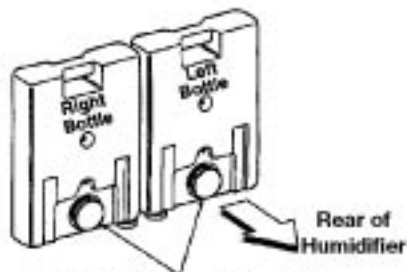

"E-Z-Fill Side-Cap" Should Always Face Rear

Turn Counterclockwise to Remove Cap

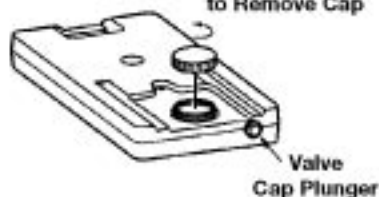

Pivoting Lid Removed for Clarity

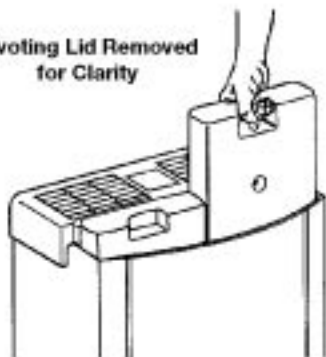



## Operating Humidifier Controls

The operating controls of your Emerson evaporative humidifier are located on the top center of the humidifier. The controls are found under the smoked cover, located between the air circulating fans. Lift the control cover by placing your finger in the round cutout and lifting. The cover will stay open. Now you can clearly see the control area. Familiarize yourself with the controls and reference the diagram of the control area for the correct naming used within this manual.

### To Operate the Controls

#### Humidity Control:



Adjust the amount of humidity depending on your needs. The humidifier will turn on and off as required to maintain level of humidity selected. A medium setting (half way between  and ) is recommended, but there are times when a low or high amount of humidity may be preferred. For constant operation of humidifier, turning the control all the way clockwise allows for the maximum amount of humidity to be evaporated into the air continuously.

**IMPORTANT:** Water damage may result if condensation starts to form on windows or walls. Humidity Control setting should be lowered until condensation no longer forms.

#### Green Humidity Light

When the selected humidity level is met, the fans will shut off and the green "Desired Humidity" light will illuminate. When more humidity is called for, the fans will turn on and the light will go out.

#### Air Flow Control

The unit is adjusted from OFF "  " to high "  " with a three speed rotary control.

The higher the air flow speed, the more water is evaporated and released into the air. Low speed "  " is the quietest and is provided for conditions that may not require as high an evaporation rate.

#### Fill Light

When the unit has a small amount of water left in it, the amber fill light  will come on and the unit will automatically shut off.

NOTE: This humidifier is designed so the right bottle as viewed from front empties first. For maximum run time between fills, let both bottles empty completely before refilling.

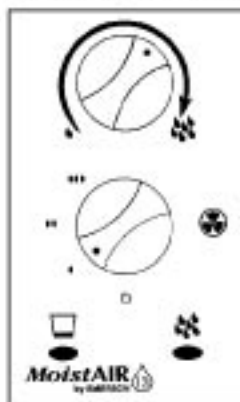

#### Manual Dryout

At the end of the humidification season or if you do not plan to run the humidifier for one week or more, you can override the automatic shutoff function to completely dry the humidifier cabinet out.

To do this, simply slide the float retainer located at the back of the humidifier cabinet to the top position of the slot it is located in. This will hold the float in an upward position and the fans will run until you turn the power off.

NOTE: Be sure to position float retainer to the normal operating mode (lowest position in slot) for normal operation.

Below is a diagram of the slot the float retainer is located in at the back of the cabinet.



## Using Your Humidifier



### Step 1

Be sure unit is full of water and plugged in.

### Step 2

Set air flow control  to desired setting.

### Step 3

Set Humidity Control  to medium position (half way between  and )

**NOTE:** Humidifier should operate with humidity control on the recommended medium setting. If it does not, the humidity is at a relatively high level. To test the unit under this condition, turn Humidity Control all the way clockwise and unit should begin to operate. After the unit has been tested, set Humidity Control to about medium or desired level.

Allow 24 to 48 hours for humidifier to adjust.

If humidity level in home is sufficient, the humidifier will only operate with Humidity Control turned all the way clockwise.

**IMPORTANT:** Water damage may result if condensation starts to form on windows or walls. Humidity Control setting should be lowered until condensation no longer forms.

### Step 4

If humidifier stops running and the amber Fill Light  is not illuminated, the green desired humidity light will illuminate. This means the humidity level is at the normal requirements for that setting or it is adjusting to the home conditions. The table below shows recommended indoor humidity levels. The figure below shows approximate relative humidity percentages which correspond to the various settings of the Humidity Control.

When Outdoor Temperature is:	Recommended Indoor Relative Humidity is:
-10°F	20%
0°F	25%
10°F	30%
20°F & above	35%

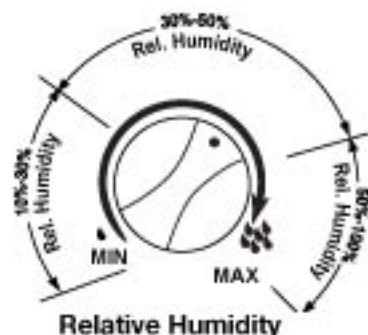

## Operating Tips for Best Performance

1. Position the humidifier at least 2 inches from any wall and away from any heat registers.
2. Do not restrict airflow from entering or exiting the humidifier.
3. Use liquid EPA Registered Bacteriostat to retard bacteria growth that may cause odors and may be harmful to your health.
4. Regular cleaning as instructed in "Cleaning Your Humidifier" section of this manual is recommended.
5. Replace the evaporative wicking filters at least once per humidification season or more depending on water conditions in your area.



## Replacement and Care of Filters

**WARNING:** To reduce the risk of shock or injury from moving parts, always unplug humidifier before removing or replacing any parts.

**CAUTION:** To help retard bacteria growth and keep maximum efficiency, the filters should be replaced at least once a season, or more often under hard water conditions. Use Emerson HDC-12 (or HDC12C in Canada) recommended replacement filter.

All filters may be rinsed in clear water only. Take care not to damage paper.

To replace the evaporative wicking filters in your Emerson humidifier, follow the instructions below.

1. Unplug humidifier, and proceed to clean. Before removing the filters, we recommend moving the humidifier to an area where floor coverings are not susceptible to water damage, i.e. kitchen or bath areas.
2. Open the pivoting lid and remove water bottles and set aside. Grasp the fan assembly front center and rear center. Lift off and set aside on a clean flat surface. The filter assemblies are now accessible.
3. Lift filter housings out of cabinet and place where you may work on them comfortably. With a soft, absorbent cloth, remove any remaining water or loose mineral deposits not trapped in the filter from the humidifier cabinet.
4. To open filter housing for easy access to filters
  - a. Deflect the two spring tabs on top of filter housing. Lift top cover off of the filter housing and set aside.
  - b. Remove the two filters and dispose of properly. Clean internal parts of humidifier per the "Cleaning Your Humidifier" section of your owner's manual.

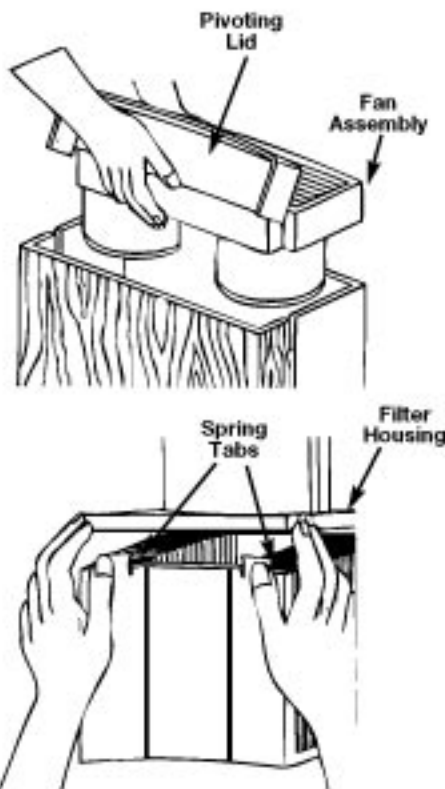

## Replacement and Care of Filters (continued)

- c. Install new filters in the filter housing track with the glue beads of the wicking pad to the inside of the filter housing.
- d. Return the top cover of the filter housing by installing the cover over the fixed tabs on the rear of the lower filter housing and pivoting the cover down over the top of the filters. Snap the cover over the two spring tabs.
- e. Replace the filter housing in the cabinet. **Note:** There is a front and back orientation. To position the filter housings correctly:
  - Be sure that spring tabs of filter housings are towards front of cabinet.
  - Align the lower portion of the filter assembly over the six ribs, located at the bottom rear of the humidifier cabinet.
- f. Position fan assembly onto the cabinet. Make sure the fan venturi (lowest cylinder section below the fan) is placed inside the filter housing.
- g. Replace water bottles.
- h. Close the pivoting lid on the fan assembly.
- i. The unit is ready for use or to be stored away for the next season.

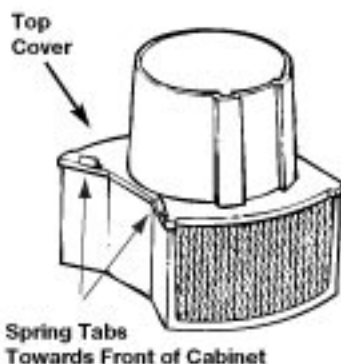
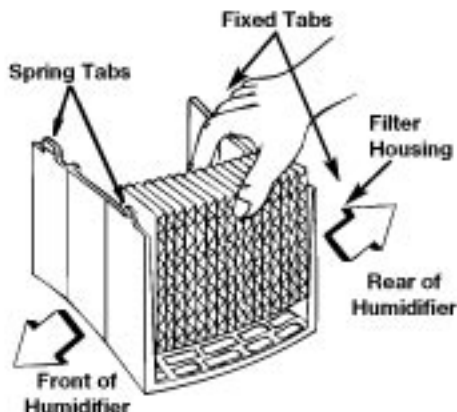

**NOTE:** For correct operation of the filter housing assembly, filters must be fully contained inside the flange of the top cover.

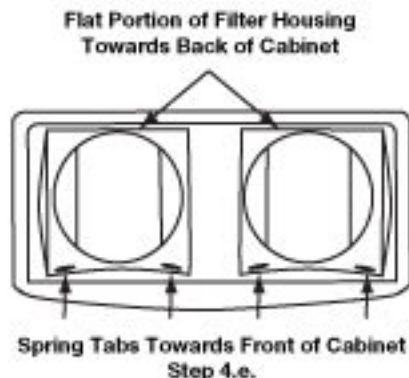

## Cleaning Your Humidifier

**CAUTION:** To reduce the risk of injury, fire or damage to humidifier, use only cleaners specifically recommended for humidifiers. Never use flammable, combustible or poisonous materials to clean your humidifier. To reduce the risk of scalds and damage to humidifier, never put hot water in humidifier.

**CAUTION:** Local water purity may vary from area to area and under certain conditions water impurities and airborne bacteria may promote the growth of microorganisms in the reservoir of a humidifier.

To retard bacteria growth that may cause odors and be harmful to your health, use only Emerson replacement filters. We also recommend using an EPA registered liquid bacteriostat, and cleaners specifically recommended for evaporative humidifiers available at your local retail store.

**NOTE:** if it is necessary to use an approved bacteriostat, follow the directions correctly. The bottles of this unit will hold 2-3/8 gallons or 9 litres of water each.

### Step 1

To make cleaning easier, the humidifier cabinet should be empty and completely dried out. To accomplish this, use the following method:

- Allow the humidifier to run until the automatic shutoff turns the humidifier "OFF".
- Unplug humidifier

**WARNING:** If humidifier is not unplugged, fan could start after housing is removed.

### Step 2

#### To Remove Parts

- Open the pivoting lid and remove water bottles and set aside. Grasp the fan assembly front center and rear center. Lift

off and set aside on a clean flat surface. The filter housings are now accessible.

- Before removing the internal parts of the humidifier cabinet, we recommend moving the humidifier to an area where floor coverings are not susceptible to water damage, i.e., kitchen or bath area. Lift the filter housing assemblies out of the cabinet and set to the side.
- Remove the water level float from the humidifier cabinet by pinching the float retainer at the back of the cabinet to release it. The cabinet should be empty before cleaning. The cabinet consists of the lower areas of the humidifier where the filters are during normal operation time.
- Empty cabinet of any remaining water.
- Proceed to "Bi-Weekly Maintenance" or "End of Season Maintenance" then continue as described below.
- Remove old filters and dispose of properly as described on page 9 and 10.

### Step 3

Install new filters (use Emerson Replacement Filters) into the location where the old filters were positioned. Install water level float at back of cabinet. Ensure that you slide the float retainer down to the lowest position in slot at back of cabinet. (See diagram of slot below). Install the filter housings with the new filters into the correct location. Position the fan assembly on top of the cabinet and return the humidifier to the desired location for use.

Refill humidifier bottles with fresh cool water. Plug the unit into a 120 volt A.C. power outlet and set the controls per the "Operating Humidifier Controls" section of this manual.

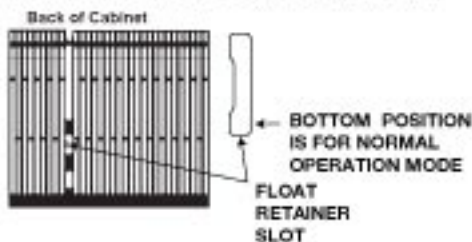

## **Cleaning Your Humidifier (continued)**

---

### **Bi-Weekly Maintenance**

#### **Removing Scale**

1. Fill the humidifier cabinet with one 8 oz. cup of undiluted white vinegar. Let solution stay 20 minutes.
2. Clean all interior surfaces with soft brush. Dampen a soft cloth with undiluted white vinegar and wipe out the humidifier cabinet to remove scale.
3. Rinse thoroughly with clean warm water to remove scale and cleaning solution before disinfecting the humidifier cabinet.
4. Dust the fan assembly and outside surfaces with a soft cloth only.

#### **Disinfecting Humidifier Cabinet and Bottles**

1. Fill humidifier cabinet with 1 teaspoon chlorine bleach in 1 gallon of water. Let solution stay 20 minutes, swishing every few minutes. Wet all surfaces normally exposed to water.

2. Empty humidifier cabinet after 20 minutes. Rinse with water until bleach smell is gone. Allow unit to dry out completely.
3. Water bottles should be cleaned in same manner.

### **End of Season Maintenance**

1. Follow bi-weekly maintenance instructions at end of humidification season.
2. Remove and throw away filters.
3. Let humidifier dry completely before storing. Do not store with water inside cabinet.
4. Store in cool, dry location.
5. Install new filters into a clean humidifier before next season begins.
6. "Bi-Weekly Maintenance" is also recommended if you do not plan to run the humidifier for one week or more.

## Troubleshooting

TROUBLE	PROBABLE CAUSE	REMEDY
Unit will not run and no control panel lights are illuminated.	<ul style="list-style-type: none"><li>No power.</li><li>Speed control in off position.</li></ul>	<ul style="list-style-type: none"><li>Check 120 volt power source.</li><li>Turn speed control clockwise.</li></ul>
Power source OK and fans still not operating.	<ul style="list-style-type: none"><li>Selected humidity level has been established.</li></ul>	<ul style="list-style-type: none"><li>Raise humidistat setting if desired.</li></ul>
Unit will not shut off.	<ul style="list-style-type: none"><li>Float is not free.</li><li>Float retainer positioned in "Manual Dryout" position (top slot at back of cabinet).</li></ul>	<ul style="list-style-type: none"><li>Free float from obstruction</li><li>Slide float retainer down to lowest position in slot at back of cabinet. (See diagram on page 11.)</li></ul>
Slow evaporation of water.	<ul style="list-style-type: none"><li>Dirty filters.</li></ul>	<ul style="list-style-type: none"><li>Change to fresh filters.</li></ul>
Left bottle not emptying and/or Fill indicator turns on before bottles are emptying.	<ul style="list-style-type: none"><li>Right bottle contains water.</li><li>Unit is not set up on a level surface. (Float will not sense water at the rear of the cabinet.)</li></ul>	<ul style="list-style-type: none"><li>The humidifier is designed so the right bottle empties first. Continue to run until fill light comes on.</li><li>Position unit level. (Some carpet padding may allow unit to sit lower in front than rear with additional weight of water bottles in the front of the cabinet.) Install caster pads under front casters. (See owner's manual.)</li></ul>
Neither bottle is emptying.	<ul style="list-style-type: none"><li>Bottle is not seated properly.</li></ul>	<ul style="list-style-type: none"><li>Check the position of bottles. Reposition so that bottle cap plunger (stem) is depressed by post in bottom of cabinet.</li></ul>
Bottles continue to empty.	<ul style="list-style-type: none"><li>Air is entering water bottles.</li></ul>	<ul style="list-style-type: none"><li>Ensure "E-Z-Fill Side-Caps" and valve assembly caps are tight.</li><li>Check for leak in water bottles.</li><li>Ensure gasket for each cap is in place.</li></ul>
A small amount of water in cabinet and fill light is on.	<ul style="list-style-type: none"><li>This is normal.</li></ul>	<ul style="list-style-type: none"><li>Approximately one inch of water remains in the cabinet after unit shuts off. Position float retainer in "Manual Dryout" position to completely dry out. See owner's manual (if applicable).</li></ul>

**CAUTION:** Use only approved EPA Registered liquid bacteriostat available from your local retail store. Use of other water treatment products may damage the filter elements. Under no circumstances should you use water treatment products designed for Rotobelt or Ultrasonic humidifiers.

### FOR TECHNICAL HELP

**If in the USA call 1-800-654-3545**

**If in Canada call 1-888-744-4687**

# Repair Parts

## Parts List for MoistAir Humidifier Model No. HD13050

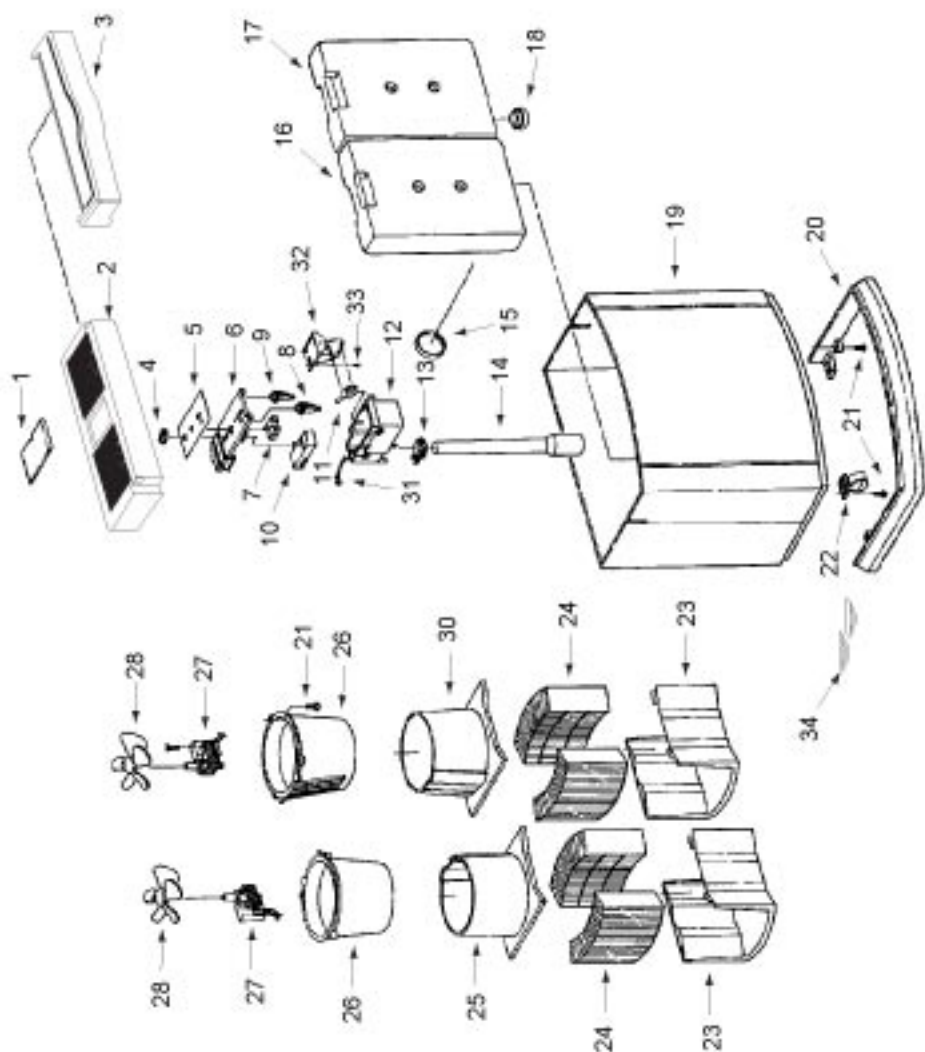

## Parts List for MoistAir Humidifier Model No. HD13050

Always order by part number - Not by key number

Key No.	Part No.	Description
18	509229-1	Cap, Valve Assembly
19	828199-10	Cabinet
20	823726	Rail, Kick
21	*	* Screw, Pan Hd, Ty "AB" #10 x 3/4
22	828515	Caster, Twin Wheel
23	823849	Support, Filter Lower
24	HDC-12 or HDC12C	† Filter, Evaporative (USA) † Filter, Evaporative (Canada)
25	828197	Support, Upper L.H. Filter
26	828534	Support, Motor
27	828115-1	Motor (Includes mounting hardware)
28	822406-1	Fan
30	828196	Support, Upper R.H. Filter
31	824120	Cord w/Plug
32	826367	Retainer, Micro Switch
33	*	* Screw, Pan Hd, Type AB #6 x 3/8
34	828920	Pad, Caster (Two)
-	SP6472	Owner's Manual (not illustrated)

† Stock item - Purchase locally or call 1-800-654-3545 from the USA or 1-866-808-6500 from Canada to order

Key No.	Part No.	Description
1	823884	Cover, Dust
2	829844	Lid, Stationary
3	829841-1	Lid, Pivoting
4	828381	Knob
5	828800	Label, Control
6	826400	Cover, Control
7	823912	Switch, Rotary
8	825858	Light, Fill
9	825859-1	Light, Humidity
10	13805-02	Humidistat
11	823728	Switch, Micro
12	826401	Enclosure, Electronics
13	824101-1	Retainer, Float
14	828200	Float, Water Level
15	824690	"Easy-Fill Side-Cap"
16	828192	Bottle, Left (Includes Key No's 15 & 18)
17	828726	Bottle, Right (Includes Key No's 15 & 18)

\* Standard Hardware item - May be purchased locally.

To order parts call: USA 1-800-654-3545 Canada 1-866-808-6500

---

FOR TECHNICAL HELP, CALL  
(800) 654-3545 FROM USA OR (888) 744-4687 FROM CANADA  
(Please have complete model number)

---

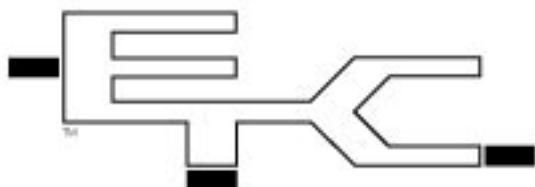

**EMERSON TOOL COMPANY**

**9999 Highway 48**

**Markham, Ontario Canada L3P 3J3**