



**☎ 1-800-243-0000**

24 HOURS A DAY, 7 DAYS A WEEK FOR LG CUSTOMER SERVICE

# Owner's Manual

## Electric and Gas Dryer

**DLE0442W/DLG0452W**

**DLE0442S/DLG0452S**

**DLE0442G/DLG0452G**

**DLE5944WM/DLG5955WM**

**DLE6942W/DLG6952W**

Thank you for buying a LG Dryer.

Please read your manual carefully, as it provides instructions on safe Installation, Use and Maintenance.

Record the Model and Serial Numbers, and retain the manual for future reference.

For more information, visit our website at <http://us.lge.com>

# PRODUCT FEATURES



## OUTSTANDING PERFORMANCE

Not to mention unmatched big capacity, you can benefit from good time efficiency, quiet operation and energy saving system.



## STAINLESS STEEL DRUM

Stainless steel drum doesn't generate any rust by nature so that rust-free drum keeps clothes away from stain all time.



## ARTISTIC DESIGN

Modern front panel look and big crystal-clear glass door make your dryer look stylish.



## DIGITAL FABRIC CARE

Multi-Level temperature control takes better care of your clothes



## EASY OF USE

An entire selection of user-friendly functions make operating the dryer easy.



## USING THE RLM (REMOTE LAUNDRY MONITOR) (DLE5944WM, DLG5955WM)

The RLM monitors status of your washer and/or dryer. You can plug the display unit into any power outlet in your home. The RLM Display Unit can be purchased separately for this dryer.

### What are Sensor Dry and Time Dry?

Your dryer provides sensor drying and time drying programs.

**Sensor Dry** : Dryer senses electronically laundry humidity and it automatically determines operation time based on the dryness of the load and the selected program. At times, you can see sudden increase or decrease on operation time. It happens because a sensor will detect laundry humidity with a certain period. Sudden change on operation time is not a malfunction.

**Time Dry** : Time Dry is that you can set operation time manually to complete drying. Or use Time Dry to have drying performance if clothes are still damp after sensor dry cycle is finished. Time Dry is more effective for heavyweight and bulky items such as king-size bed sheets and thick work clothes.

# TABLE OF CONTENTS

|                                                         |       |
|---------------------------------------------------------|-------|
| PART1. SPECIFICATIONS .....                             | 3     |
| PART2. IMPORTANT WARRANTY AND SAFETY INSTRUCTIONS ..... | 4-6   |
| PART3. INITIAL STEPS FOR INSTALLING YOUR DRYER .....    | 7-12  |
| PART4. ACCESSORIES INSTALLATION .....                   | 13    |
| PART5. ELECTRICAL REQUIREMENTS FOR ELECTRIC DRYER ..... | 14-17 |
| PART6. ELECTRICAL REQUIREMENTS FOR GAS DRYERS .....     | 18    |
| PART7. GAS REQUIREMENTS AND INSTRUCTIONS.....           | 19    |
| PART8. EXHAUST REQUIREMENTS AND MAINTENANCE.....        | 20-21 |
| PART9. OPERATING YOUR DRYER.....                        | 22-27 |
| PART10. TROUBLESHOOTING GUIDE .....                     | 28-30 |
| LG DRYER LIMITED WARRANTY .....                         | 31    |

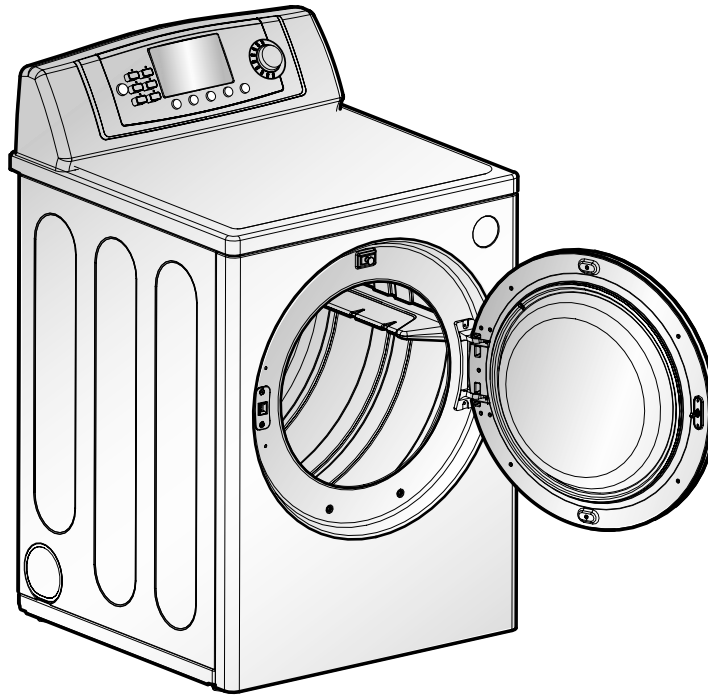

- Type : Electric and Gas Dryer
- Rating : Please refer to the rating label regarding detailed information.
- Size : 27 x 30 x 42.75(inch)
- Capacity : IEC 7.3cu.ft. (22.5 lb)
- Weight : 126 lbs (57.2 kg)

Specifications are subject to change by manufacturer.

■ ACCESSORIES

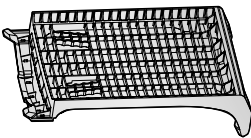

Dryer rack (1 each)

*See page 26 for how to use.*

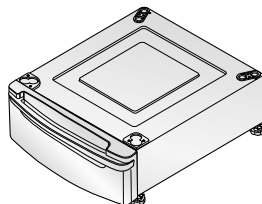

Pedestal (1 each)  
Purchased Separately

*See page 14 for how to use.*



Remote Laundry Monitor  
Purchased Separately  
(DLE5944WM, DLG5955WM)

## SEEKING WARRANTY ASSISTANCE

The Warranty for your Dryer is located at the end of this manual. Warranty Service is available by contacting your nearest LG Service Center. If this product is installed and operated per this manual, LG will repair or replace any parts defective in material or workmanship throughout the Warranty period, beginning the Date of Purchase.

**WARNING!**

For your safety, the recommendations in this manual must be followed. To reduce the risk of fire or explosion, electric shock, or to prevent property damage, personal injury, or death when using your appliance, follow basic precautions, including the following.

**Warranty Restriction:** If the dryer is subjected to other than private family use, all warranty coverage is effective for only 90 days.

You will need the complete Model and Serial Number when requesting Warranty Service. Proof of purchase date is required.

Use the space below to record the model number and serial number of your new LG dryer.

Model No. \_\_\_\_\_

Serial No. \_\_\_\_\_

Date of Purchase \_\_\_\_\_

\* Staple your receipt HERE.

## IMPORTANT SAFETY INSTRUCTIONS

 **WARNING!**

**To help reduce any risk of electric shock, fire, or other personal or property injury when using your dryer, please exercise care and follow basic safety precautions, including the following:**

- 1) Read all instructions before using the appliance.
- 2) Do not dry articles that have come into contact with gasoline, dry-cleaning solvents, or other flammable or explosive substances, as they give off vapors that could ignite or explode.
- 3) Do not allow children to play on or in the appliance. Close supervision of children is necessary when using the appliance.
- 4) Before the appliance is removed from service or discarded, remove the door to the drying compartment.
- 5) Do not reach into the appliance if the drum is moving.
- 6) Do not install or store this appliance where it will be exposed to the weather.
- 7) Do not tamper with controls.
- 8) Do not repair or replace any part of the appliance or attempt any servicing unless specifically recommended in the user-maintenance instructions.
- 9) Do not use heat to dry articles containing foam rubber or similarly textured rubber-like materials.
- 10) Clean lint screen before or after each load.
- 11) Keep area around the exhaust opening and adjacent surrounding areas free from the accumulation of lint, dust, and dirt.
- 12) The interior of the appliance and exhaust duct should be cleaned periodically by qualified service personnel.
- 13) Do not place items exposed to cooking oils in your dryer. Items contaminated with cooking oils may contribute to a chemical reaction that could cause a load to catch fire.
- 14) Do not use fabric softeners or products to eliminate static unless recommended by the manufacturer of the fabric softener or product.

**SAVE THESE INSTRUCTIONS****GROUNDING INSTRUCTIONS**

This appliance must be grounded. In the event of malfunction or breakdown, grounding will reduce the risk of electric shock by providing a path of least resistance for electric current. This appliance is equipped with a cord having an equipment-grounding conductor and a grounding plug. The plug must be plugged into an appropriate outlet that is properly installed and grounded in accordance with all local codes and ordinances.

**WARNING** - Improper connection of the equipment-grounding conductor can result in a risk of electric shock. Check with a qualified electrician or service person if you are in doubt as to whether the appliance is properly grounded.

Do not modify the plug provided with the appliance: if it will not fit the outlet, have a proper outlet installed by a qualified electrician.

This appliance must be connected to a grounded metal, permanent wiring system or an equipment-grounding conductor must be run with the circuit conductors and connected to the equipment-grounding terminal or lead on the appliance.

## WHAT TO DO IF YOU SMELL GAS:

- Do not try to light a match or cigarette, or turn on any gas or electrical appliance.
- Do not touch any electrical switches. Do not use any phone in your building.
- Clear the room, building or area of all occupants.
- Immediately call your gas supplier from a neighbor's phone. Follow the gas supplier's instructions carefully.
- If you cannot reach your gas supplier, call the fire department.

## WARNING

To reduce the risk of fire or explosion, electric shock, property damage, personal injury or death when using this appliance, please follow all instructions and information, including those in this manual and instructions and information provided by your gas supplier, including the following:

- Do not store or use any gasoline, dry-cleaning solvents any other flammable vapors or liquids in the area surrounding this appliance.
- Do not dry anything that has ever had anything flammable on it, even after washing.
- No washer can completely remove oil. Do not dry any articles that have ever had any kind of oil on them, including cooking oil.
- Articles containing foam, rubber, rubber-like materials, plastic or similar materials should be dried on a clothesline or by using an air cycle.
- Failure to follow these instructions can result in fire, death or serious injury.
- A qualified service person or company must perform installation and service of this appliance.

## **WARNING!**

- Keep flammable materials and vapors, such as gasoline, away from dryer.
- Place dryer at least 18 inches above the floor for a garage installation.
- Failure to do so can result in death, explosion or fire.

## California Safe Drinking Water and Toxic Enforcement Act

This act requires the governor of California to publish a list of substances known to the state to cause cancer, birth defects or other reproductive harm and requires businesses to warn customers of potential exposure to such substances.

Gas appliances can cause minor exposure to four of these substances, namely benzene, carbon monoxide, formaldehyde and soot, caused primarily by the incomplete combustion of natural gas or LP fuels.

Properly adjusted dryers will minimize incomplete combustion. Exposure to these substances can be minimized further by properly venting the dryer to the outdoors.

The following instructions will help guide you through the initial steps of setting up your dryer for use. Please note that every section of this manual provides important information regarding the preparation and use of your dryer, and it is important that you review this entire manual before proceeding with any installation or use. More detailed instructions concerning electrical connections, gas connections, and exhaust requirements are provided at other parts of this manual.

**STEP 1 Positioning the Dryer.**

Choose a location with a solid floor for your dryer. Place the dryer at least eighteen inches above the floor for a garage installation. After placing the dryer in the desired location, please make sure that it has the required clearances shown below, and sections on Exhaust and Maintenance requirements. If you are installing your dryer in a manufactured or mobile home, please refer to STEP 9 below for additional instructions.

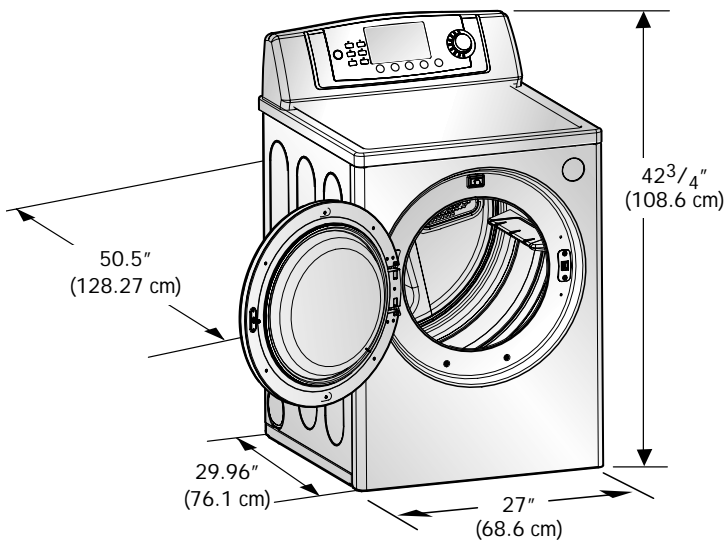

\* Most installations require a minimum 5 1/2 in. (14 cm) clearance behind the dryer for the exhaust vent with elbow.

**Note**

Leveling legs should be secured.  
 All four legs are stably placed on the solid and even floor.  
 If dryer is not level, laundry may not tumble properly and sensor will not detect the accurate humidity information.  
 When adjusting leveling, please be cautious not to have serious injuries on your fingers and toes.

**Certain minimum clearances are required above, behind, and to the sides of the unit, as shown below.** Those required minimum clearances are set forth in the picture below. Please also keep the following instructions in mind when installing in a closet or recessed area:

- Consider allowing additional clearance for installation and servicing.
- Wall, door and floor molding may force additional clearances.
- An additional inch of clearance is recommended to minimize noise transfer .
- Consider space needed for companion appliances.
- For closet installations, the picture below shows the minimum required ventilation openings for the door. A louvered door with comparable ventilation openings is also acceptable.

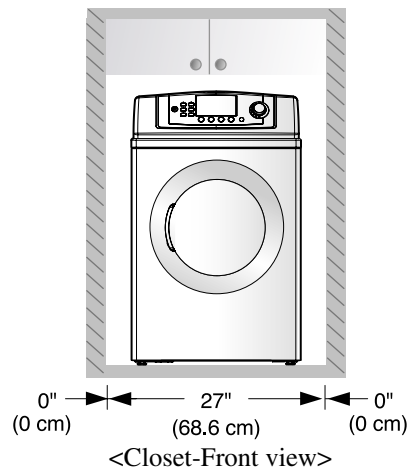
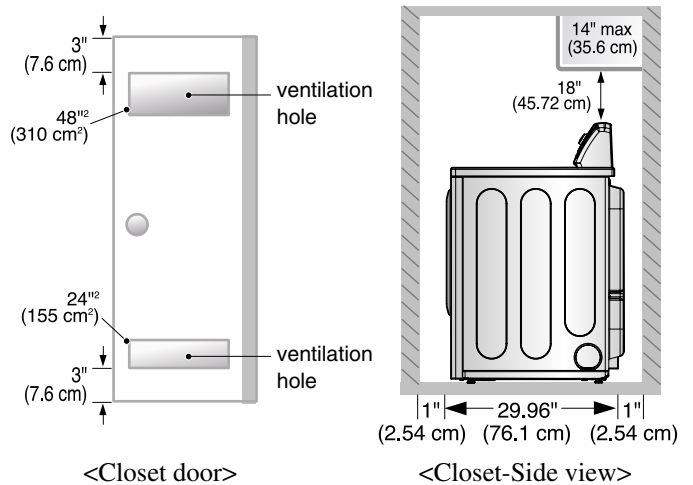

Once in position, adjust the leveling legs of the dryer until it is level from left to right and from front to back. The leveling legs must remain firmly on the floor and the dryer should not rock. The maximum slope of the dryer from left to right or from front to back should not exceed 2.5 cm (1 inch). If the dryer is not level, and if the slope exceeds 2.5 cm (1 inch), a load may not tumble properly and internal sensors may malfunction. Note: Other sections of this manual also provide important information concerning the placement of and clearances for your dryer. Please review this entire manual before proceeding with any installation.

### STEP 2 Procedure for Reversing the Door

The door on your dryer can be installed to open either to the left or the right. Follow these procedures to reverse the direction in which your door opens:

#### Note

Door and latch should be aligned at the center when closed. Otherwise, door is improperly closed and opened.

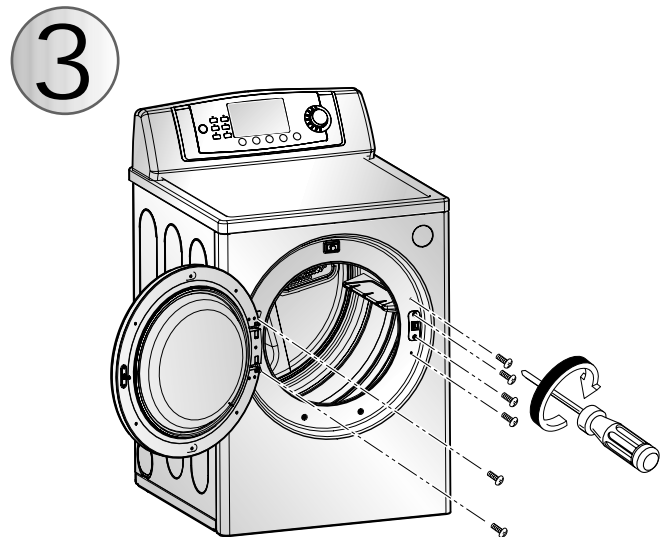
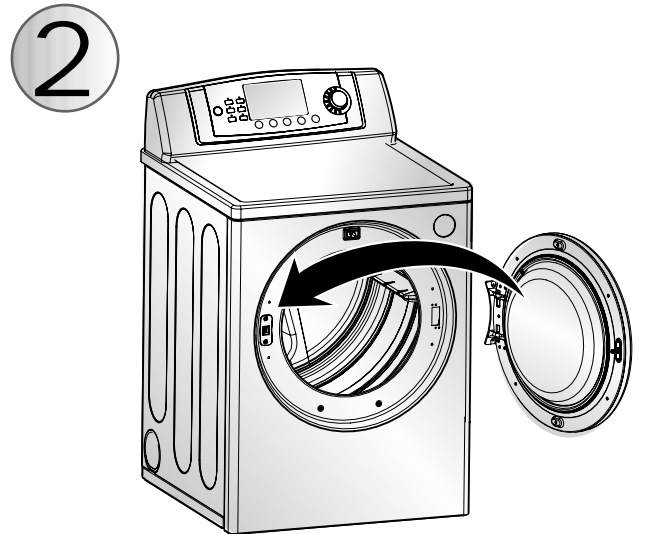



**STEP 3 Connecting the Exhaust and Venting System.**

**⚠ WARNING!**

- Use a heavy metal vent.
- Do not use a plastic vent.
- Do not use a metal foil vent.
- Failure to follow these instructions can result in death or fire.
- Clean old ducts before installing this dryer

**Note**

**Vent end will face to the outside home and improper taping and unstable installation of vent will cause undesirable drying performance.**

In addition to the following warnings, please refer to manual section on Exhaust Requirements and Maintenance. **IMPORTANT:** To reduce the risk of fire, combustion, and gas accumulation, the dryer must be vented to the outdoors. Please follow the instructions (and all others in this manual) very carefully.

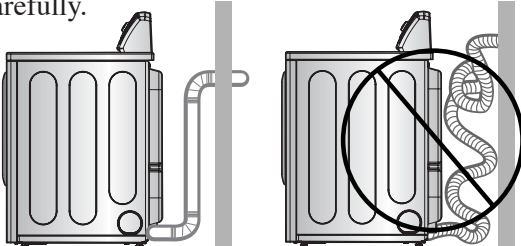

- Do not use thin plastic or foil ducting.
- Rigid or semi-rigid metal ducting is recommended for use as transition ducting between the dryer and the wall. In special installations when it is impossible to make a connection with the above recommendations, then a UL-listed flexible metal transition duct may be used between the dryer and wall connection only. The use of this ducting will affect dry time.
- Position the Dryer such that the exhaust duct run is as short as possible.
- **Clean old ducts before installing this dryer**
- The male end of each section of exhaust duct must point away from the dryer
- Use as few elbow joints as possible.
- Use duct tape on all duct joints
- Insulate ductwork that runs through unheated areas in order to reduce condensation and lint build-up on pipe walls; and
- **PLEASE BE AWARE THAT FAILURE TO EXHAUST THE DRYER CORRECTLY WILL VOID THE DRYER'S WARRANTY.**

**ALTERNATE EXHAUST DIRECTIONS**

1. Remove a screw and exhaust duct.

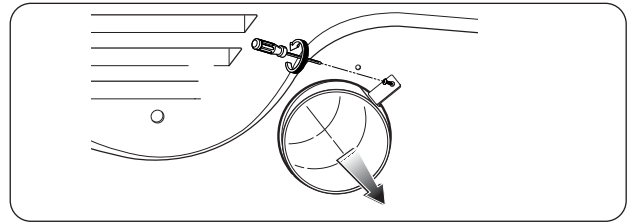

- 2-1. Detach and remove the knockout that matches the desired venting direction (Right side not available on Gas Dryers) ①, ②, ③ the order of work.

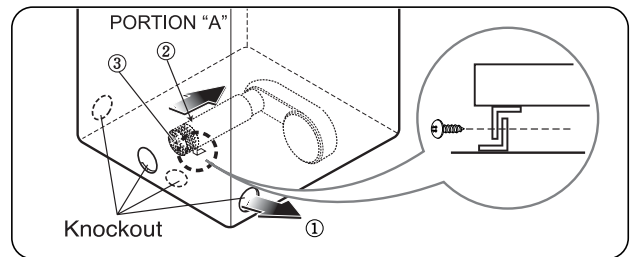

- 2-2. Reconnect the duct to the blower housing and attach the duct to the base. (Duct is a SVC part)

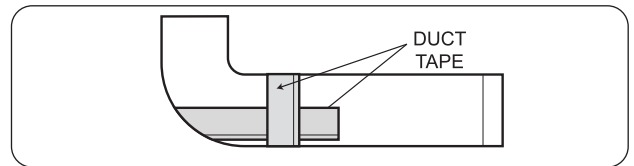

- 3-1. Pre-assemble 4" elbow with 4" duct. Wrap duct tape around joint.

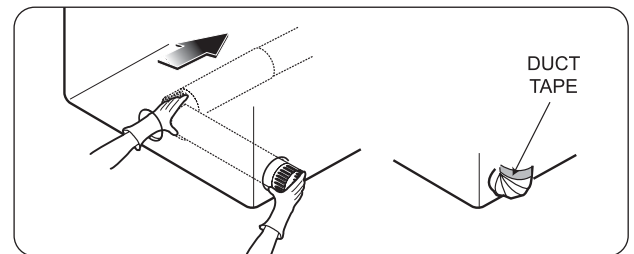

- 3-2. Insert elbow duct assembly first through the side opening and connect the elbow to the internal duct.

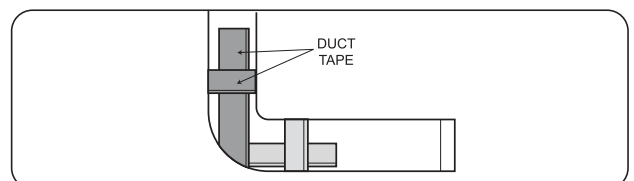

**STEP 4 Connection of Gas Supply**

(Gas dryer only). In addition to the following, please refer to manual section on Gas Requirements and Instructions.

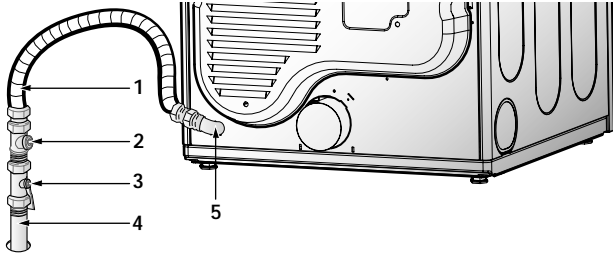

1. New stainless steel flexible connector. Use this type of connector only if allowed by local codes. Use Design AGA Certified Connector.
2. 1/8" NPT Pipe Plug (for checking inlet gas pressure)
3. Equipment Shut-Off Valve- Installed within 6' (1.8 m) of dryer
4. Iron Pipe. Shorter than 20' (6.1 m) Use 3/8" pipe. Longer than 20' (6.1 m) - Use 1/2" pipe.
5. 3/8" N.P.T. Gas Connection

**Note**

Make sure the burner nozzle is proper for the type of gas you are provided with.

For instance, using LPG with LNG nozzle will result in death, fire or explosion. Or using LNG with LPG nozzle will not ignite burner.

If needed, nozzle conversion should be done by a qualified service technician and mark or put the label of the current type of nozzle on the dryer.

1. Confirm that the type of gas available in your laundry room is appropriate for the dryer. The dryer is prepared for Natural Gas with a 3/8" NPT gas connection.
2. Remove the shipping cap from the gas connection at the back of the dryer. Make sure that you don't damage the threads of the gas connection pipe when you remove the shipping cap.
3. Connect the dryer to your laundry room's gas supply using a new flexible stainless steel connector (as noted below, only use a new stainless steel flexible connector if allowed by your local codes).
4. Securely tighten all connections between the dryer and your laundry room's gas supply. Turn on your laundry room's gas supply and check all pipe connections (both internal and external) for gas leaks with a non-corrosive leak detection fluid. Refer to Part 7 (page 20)
5. For LP (Liquefied Petroleum) gas connection, refer to this manual's section entitled Gas Requirements and Instructions.

**STEP 5 Electrical Plug Connections**

Following are several warnings and instructions concerning making the electrical connection for electric dryers. More detailed information concerning the electrical connection is provided at the manual section entitled Electrical Requirements For Electric Dryer and it is important that you thoroughly review that section, and the remainder of this manual, before taking any steps to install or use this dryer.

1. Use only a new U.L. listed No. 10 (copper wire only) three conductor power supply cord kit rated 240 Volts (minimum) 30 Amperes and labeled as suitable for use in a clothes dryer.
2. Four-wire cord is required for manufactured (mobile) home installations and use and where local codes do not allow grounding of this appliance through neutral.
3. Electrical Plug Connections.
4. For additional instruction on connecting the dryer to an electrical power source, please refer to this manual's section on Electrical Requirements and Electric Dryer.

**Note****Burner input requirements**

If your house is located at the elevation up to 10,000 feet.

Adjusting burner input setting is not needed in this elevation because A.G.A certifies this dryer will not have any problem with the B.T.U rating at this altitude.

If your house is at above 10,000 feet, you are required to adjust a four percent(4%) reduction of the burner B.T.U rating indicated on the model/serial rating plate.

**⚠ WARNING!**

- Use a new UL approved 30 amp power supply cord or 10 gauge solid copper wire.
- Use a UL approved strain relief.
- Disconnect power before making electrical connections.
- Connect neutral wire(white or center wire) to center terminal.
- Ground wire(green or bare wire) must be connected to green ground connector.
- Securely tighten all electrical connections
- See installation instructions for complete instructions.
- Failure to do so can result in fire or electrical shock.

**STEP 6 Preparation of the Dryer.**

Prior to the first use of this appliance, use all-purpose cleaning products or a solution of detergent and water, with damp clothes to remove from the inside of the dryer drum/drying compartment any dust or dirt that may have accumulated the inside of the dryer. Plug-in your dryer after reviewing the following parts on your dryer's Electrical Requirements.

**STEP 7 Confirming Heat Source Operation.****Confirming Heat Source in Gas Dryers**

Close the door to the dryer drum/drying compartment and, after completing all steps in this manual for proper installation of this dryer, start the dryer on a heat setting, as described more fully in the operating instructions that accompany the dryer. After the dryer starts, the igniter will glow red and the main burner will ignite.

**Warning:** If all air is not purged from the gas line, the gas igniter may go off before the gas and the main burner have ignited. If this happens, the igniter will re-attempt gas ignition after approximately two minutes.

**Confirming Heat Source in Electric Dryers**

Close the door to the dryer drum/drying compartment and, after completing all steps in this manual for proper installation of this dryer, start the dryer on a heat setting, as described more fully in the operating instructions that accompany the dryer. The exhaust air or the exhaust pipe should be warm after the dryer has been operating for three minutes.

**STEP 8 Dryer Airflow.**

Effective dryer operation requires appropriate dryer airflow. The adequacy of the airflow can be measured by evaluating the static pressure. Static pressure in the exhaust duct can be measured with a manometer, placed on the exhaust duct approximately 2 ft. (60.9 cm) from the dryer. Static pressure in the exhaust duct should not exceed 0.6 inches (1.5 cm). The dryer should be checked with the dryer running with no load.

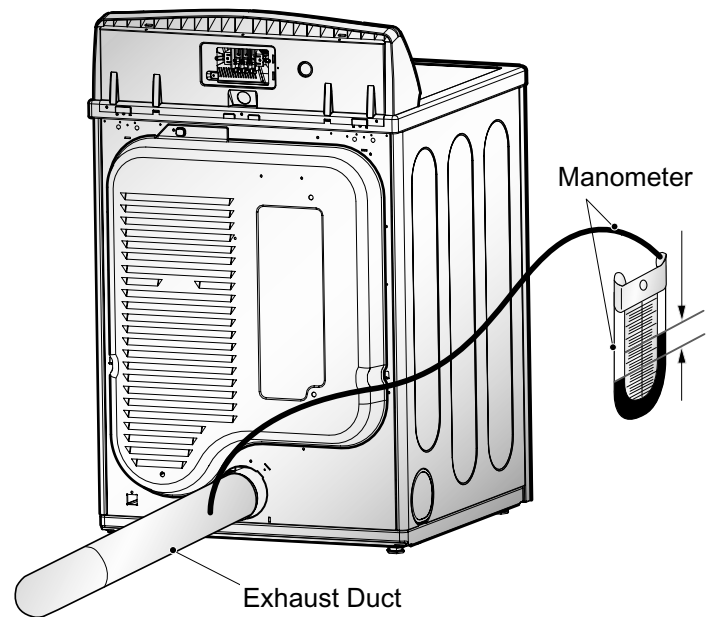
**Measuring Static pressure**

**MAXIMUM STATIC  
PRESSURE IN  
WATER COLUMN**

0.6 inch (1.5 cm)

### STEP 9 Additional Instructions for Installation of Your Dryer in a Manufactured or Mobile Home.

The following instructions are applicable to installations of the dryer in a manufactured or mobile home. Any installation in a manufactured or mobile home must comply with the Manufactured Home Construction and Safety Standards Title 24 CFR, Part 32-80 or Standard CAN/CSA0Z240 MH and local codes and ordinances. If you are uncertain whether your proposed installation will comply with these standards, please contact a service and installation professional for assistance.

The following instructions apply to any installation of the dryer in a manufactured or mobile home:

- 1) The gas dryer must be permanently attached to the floor.
- 2) The electrical connection for an electric dryer must be a 4-wire connection. More detailed information concerning the electrical connection is provided at the manual section entitled Electrical Requirements for Electric Dryer
- 3) To reduce the risk of combustion and fire, the dryer must be vented to the outside.

#### **WARNING!**

DO NOT connect exhaust ducts with metal screws or fasteners that extend into the duct.

- 4) Electric dryers may be vented to the outside using the back, left, right, or bottom panel.
- 5) Gas dryers may be vented to the outside using the back, left, or bottom panel. Gas dryer may not be vented to the outside using the right side panel because of the burner housing.
- 6) The dryer exhaust duct must be affixed securely to the manufactured or mobile home structure, and the exhaust duct must be made of a material that will resist fire and combustion, and it is recommended that you use a rigid or flexible metal pipe.
- 7) DO NOT connect the exhaust duct with any other duct, vent, chimney, or other exhaust duct.
- 8) Make sure the dryer has adequate access to outside fresh air to ensure proper operation. The opening for outside fresh air must be at least 25 in<sup>2</sup> (163 cm<sup>2</sup>).
- 9) It is important that the clearance of the duct from any combustible construction be at least 2 inches (5 cm), and, when venting the dryer to the outdoors, the dryer can be installed with a clearances of 1 inch at the sides and back of the dryer.
- 10) Please be aware that venting materials are not supplied with the dryer. You should obtain the venting materials necessary for proper installation.

#### **WARNING!**

DO NOT vent the exhaust duct under the manufactured or mobile home.

## Pedestal Installation Instructions

**1** Remove pedestal, installation hardware, and instructions from the shipping carton.

**2** Position dryer on top of the pedestal.  
**NOTE :** Because of the weight of the dryer two or more people may be needed.

**NOTE :** If dryer was previously installed, uninstall it as follows:

### A. Uninstalling an electric dryer:

- 1) Unplug the power supply cord,
- 2) Pull the dryer away from the wall enough to loosen the vent clamp. Loosen the clamp and carefully remove the exhaust vent from the dryer exhaust outlet.

### B. Uninstalling a gas dryer:

- 1) Shut off Gas
- 2) Unplug Power Cord
- 3) Disconnect Gas Line from Dryer
- 4) Pull away and loosen vent clamp.  
Disconnect venting.

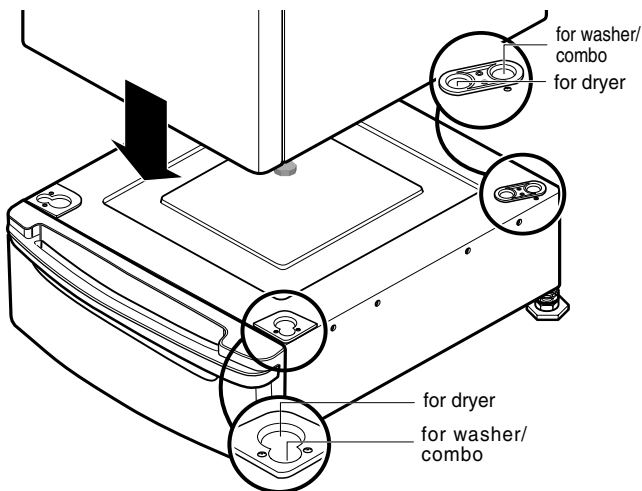

**3** Remove the paper from the bracket.

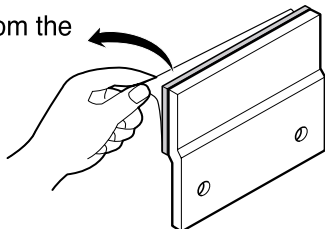

**4** Attach the double-faced tape of the bracket to the dryer as shown so the bent parts of the brackets align with the edge and can be attached to the pedestal with screws.  
**NOTE :** Attach the lower side first.

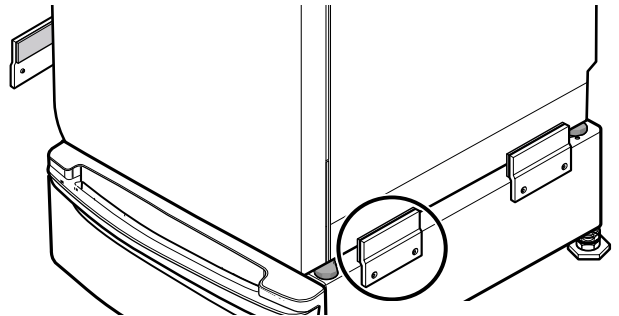

**5** Be sure to press the adhesive parts of the brackets firmly to the appliance.

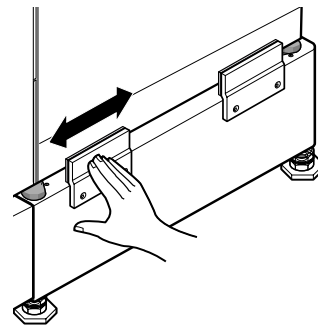

**6** Install the eight (8) screws(supplied) to attach the brackets to the pedestal.

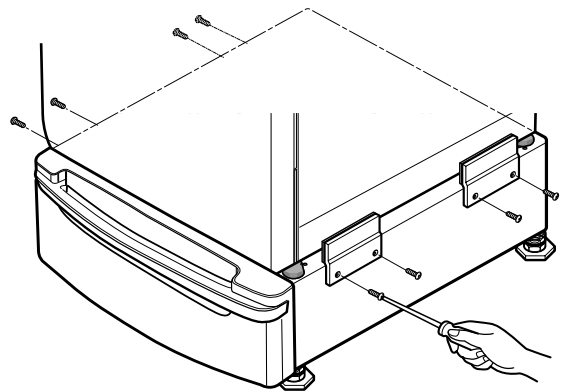

**7** Move the dryer to the desired place.

**NOTE :** The appliance and pedestal assembly must be placed on a solid and level floor for proper operation. Adjust the legs of the appliance and pedestal by turning with a wrench. Then, adjust the lock unit toward the pedestal while holding the pedestal leg using a wrench.

Following are additional instructions regarding electrical connections and requirements for electric dryers.

**⚠ Important Warning:** To help prevent fire, electric shock, serious injury or death, the wiring and grounding must conform to the latest edition of the National Electrical Code, ANSI/NFPA 70 and all applicable local regulations. Please contact a qualified electrician to check your home's wiring and fuses to ensure that your home has adequate electrical power to operate the dryer.

120V/ 208V, 60 Hertz, 3-Wire Installation

120V/ 240V, 60 Hertz, 3-Wire Installation

### Instructions for Grounding of your Electric Dryer:

- a) Please note that the wiring diagram is provided Inside the dryer cabinet.
- b) This dryer must be connected to a grounded metal, permanent wiring system; or an equipment-grounding conductor must be run with the circuit conductors and connected to the equipment-grounding terminal or lead on the dryer.
- c) The dryer has its own terminal block that must be connected to a separate branch, 60 Hertz, single phase circuit, AC (alternating current) circuit, fused at 30 Amperes (the circuit must be fused on both sides of the line). **ELECTRICAL SERVICE FOR THE DRYER SHOULD BE OF MAXIMUM RATE VOLTAGE LISTED ON THE NAMEPLATE. DO NOT CONNECT DRYER TO 110, 115, OR 120 VOLT CIRCUIT.**
- d) If branch circuit to dryer is fifteen feet (4.50 m) or less in length, use U.L. (Underwriters Laboratories) listed No. 10 A.W.G. wire (copper wire only), or as required by local codes. If over fifteen feet (4.50 m), use U.L. (Underwriters Laboratories) listed No. 8 A.W.G. wire (copper wire only), or as required by local codes. Allow sufficient slack in wiring so dryer can be moved from its normal location when necessary.
- e) The power cord (pigtail) connection between wall receptacle and dryer terminal block IS NOT supplied with dryer. Type of pigtail and gauge of wire must conform to local codes and with instructions mentioned on the following pages.
- f) The method of wiring the dryer is optional and subject to local code requirements. Refer to examples on next page.
- g) You must select the method by which to wire your dryer according to local code and ordinance requirements. Sample methods are included in the following pages.

### **⚠ WARNING!**

Label all wires prior to disconnection when servicing the dryer, because wiring errors can cause serious injury to you and your dryer.

Review the following options to determine the appropriate electrical connection for your home:



**4-wire receptacle  
(NEMA type 14-30R)**

Use the instructions at this section if your home has a 4-wire receptacle (NEMA type 14-30R) and you will be using a UL listed, 120/240 volt minimum, 30 amp, dryer power supply cord.



**3-wire receptacle  
(NEMA type 10-30R)**

Use the instructions at this section if your home has a 3-wire receptacle (NEMA type 10-30R) and you will be using a UL listed, 120/240 volt minimum, 30 amp, dryer power supply cord.

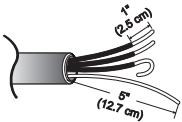

**4-wire direct**

If this type is available at your home, you will be connecting to a fused disconnect or circuit breaker box

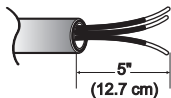

**3-wire direct**

If this type is available at your home, you will be connecting to a fused disconnect or circuit breaker box

**Note**

- Screw power supply wire to the terminal block. Colored wire should be connected to same color screw. Wire color indicated on manual is connected to the same color screw in block. Otherwise, excessive current is applied resulting in damages on product and heating failure.
- Appropriate screwing is essential. Incomplete screwing also may cause loose connection or unscrewing because of excessive screw abrasion.
- Loose screwing may cause connection error, which result in death, fire or serious injury.

**4-wire connection : Direct wire**

**Important :** Grounding through the neutral conductor is prohibited for (1) new branch-circuit installations, (2) mobile homes, and (3) recreational vehicles, and (4) areas where local codes prohibit grounding through the neutral conductor.

Prepare minimum 5ft(1.52m) of length in order for dryer to be replaced.

First, peel 5 inch (12.7cm) of covering material from end. Make a 5 inch of ground wire bared. After cutting 1½ inch (3.8cm) from 3 other wires, peel insulation back 1inch (2.5cm). Make ends of 3 wires a hook shape.

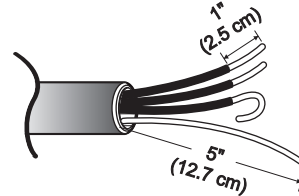

Then, put the hooked shape end of the wire under the screw of the terminal block(hooked end facing rightward) and pinch the hook together and screw tightly.

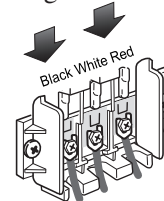

1. Connect neutral wire(white) of power cord to center terminal block screw.
2. Connect red and black wire to the left and right terminal block screws.
3. Connect ground wire(green) of power cord to external ground screw and move neutral ground wire of appliance and connect it to center screw.
4. Make sure that the strain relief screw is tightened. and be sure that all terminal block nuts are on tight and power cord is in right position.

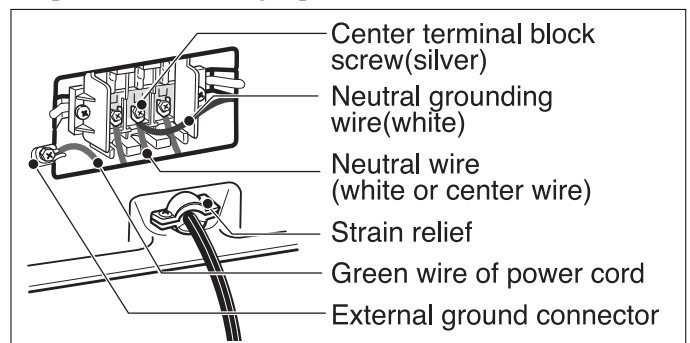

**3-wire connection : Direct wire**

**Important :** Grounding through the neutral conductor is prohibited for (1) new branch-circuit installations, (2) mobile homes, and (3) recreational vehicles, and (4) areas where local codes prohibit grounding through the neutral conductor.

Prepare minimum 5ft(1.52m) of length in order for dryer to be replaced.

First, peel 3 1/2 inch (8.9cm) of covering material from end and bare 1 inch from the ends.

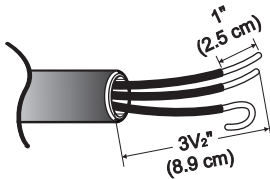

Then, put the hooked shape end of the wire under the screw of the terminal block(hooked end facing rightward) and pinch the hook together and screw tightly.

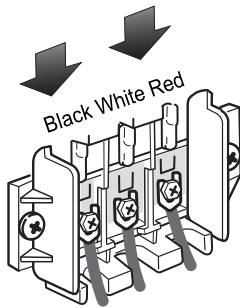

1. Connect neutral wire(white) of power cord to center terminal block screw.
2. Connect red and black wire to the left and right terminal block screws.
3. Make sure that the strain relief screw is tightened and be sure that all terminal block nuts are on tight and power cord is in right position.

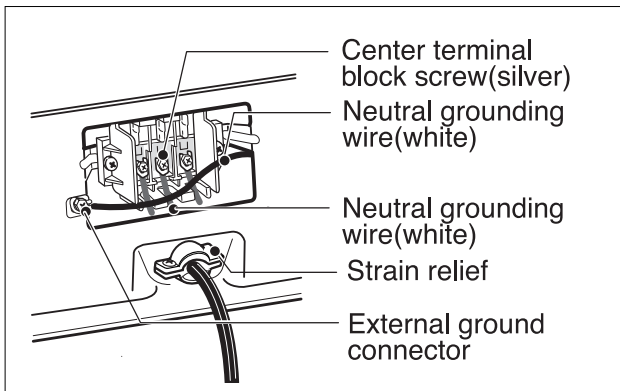

**Option 1: 4-wire connection with a Power supply cord.**

- If your local codes or ordinances do not allow the use of a 3 wire connection, or you are installing your dryer in a mobile home, you must use a 4-wire connection.

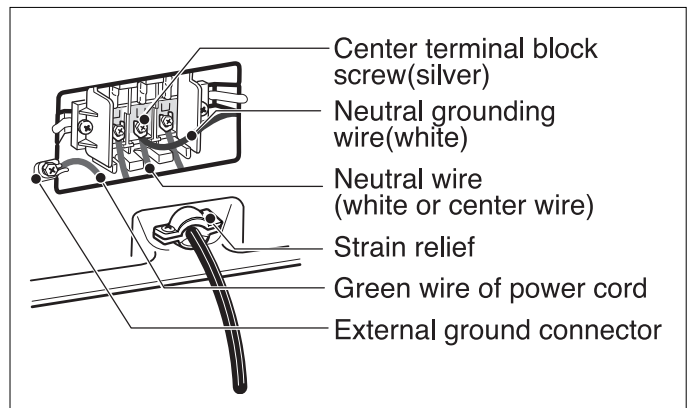
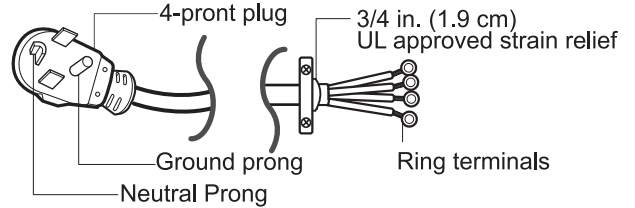
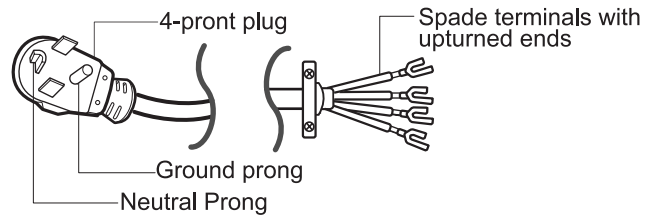
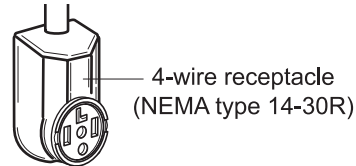

1. Connect neutral wire(white) of power cord to center terminal block screw.
2. Connect red and black wire to the left and right terminal block screws.
3. Connect ground wire(green) of power cord to external ground screw and move neutral ground wire of appliance and connect it to center screw.
4. Make sure that the strain relief screw is tightened. and be sure that all terminal block nuts are on tight and power cord is in right position.



**Option 2: 3-Wire Connection with a Power Supply Cord**

If your local codes or ordinances permit the connection of a frame-grounding conductor to the neutral wire, use these instructions. If your local codes or ordinances do not allow the connection of a frame-grounding conductor to the neutral wire, use the instructions under **Section 3: Optional 3-wire connection.**

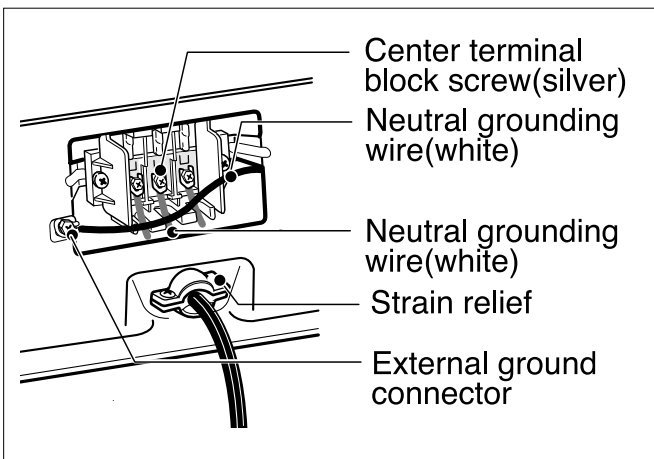
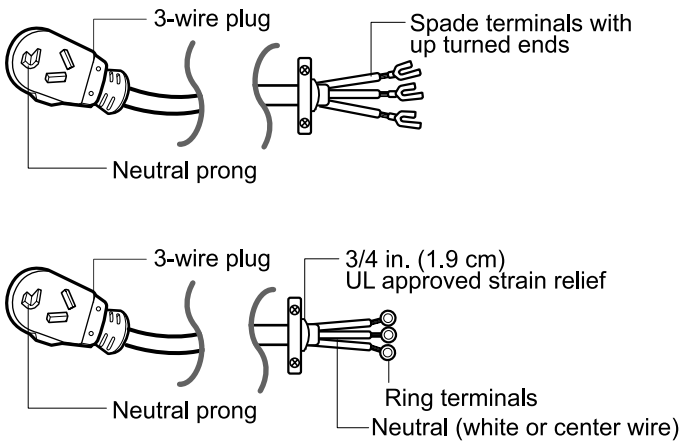
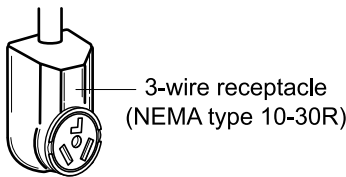

**Option 3: Optional 3-wire connection.**

- If your local codes or ordinances do not allow the connection of a frame-grounding conductor to the neutral wire, use the instructions under this section.

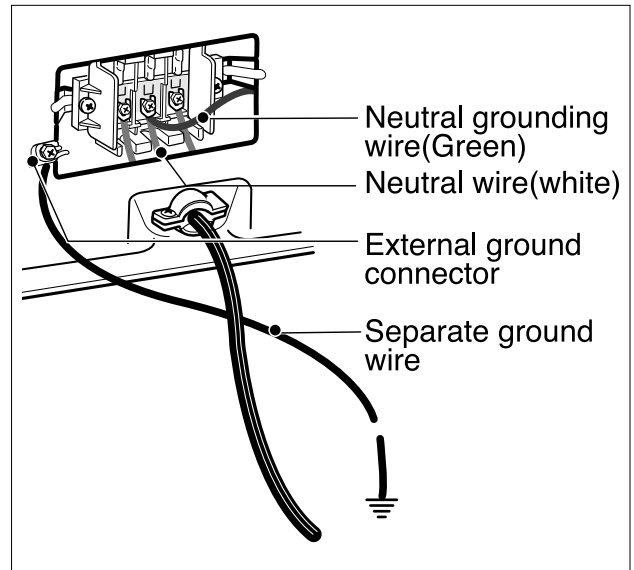
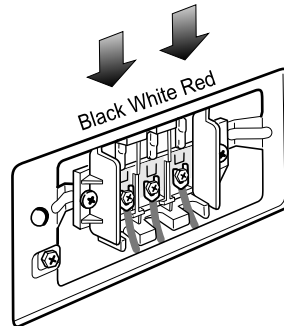

1. Connect neutral wire (white) of power cord to center terminal block screw.
2. Connect ground wire of appliance and neutral wire of power cord to center terminal block screw.
3. Connect red and black wire to the left and right terminal block screws.
4. Make sure that the strain relief screw is tightened, and be sure that all terminal block nuts are on tight and power cord is in right position.
5. Connect an independent ground wire from external ground connector to proper ground.

### 120 Volt, 60 Hertz, with 3-Prong Grounding Plug

Following are additional instructions regarding electrical connections and requirements for gas dryers.

**⚠ Important Warning:** To help prevent fire, electric shock, serious injury or death, the wiring and grounding must conform to the latest edition of the National Electrical Code, ANSI/NFPA 70, or the Canadian Electrical Code, CSA C22.1, and all applicable local regulations. Please contact a qualified electrician to check your home's wiring and fuses to ensure that your home has adequate electrical power to operate the dryer.

#### Electrical Requirements for Your Dryer:

- Please note that the wiring diagram is provided inside the dryer control hood. Label all wires prior to disconnection when servicing the dryer, because wiring errors can cause serious injury to you and your dryer.
- Your dryer is designed to be used on a separate branch, polarized, three-wire, effectively grounded, 120 Volt, 60 Hertz, AC (alternating current) circuit protected by a 15 Ampere fuse, equivalent fusetron or circuit breaker.
- Use separately fused circuits for washers and dryers, and **DO NOT** operate a washer and a dryer on the same circuit.

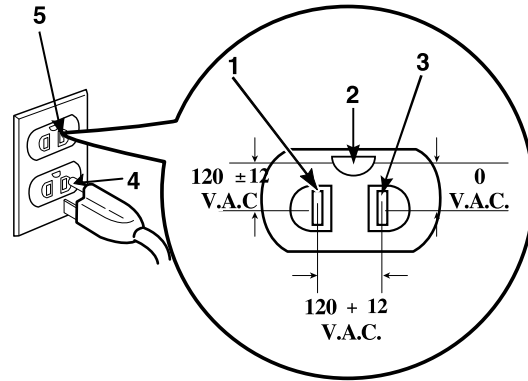

#### STANDARD 120 VOLT, 60 HERTZ, 3-WIRE EFFECTIVELY GROUNDED CIRCUIT

- |   |                       |
|---|-----------------------|
| 1 | L1                    |
| 2 | Ground                |
| 3 | Neutral Side          |
| 4 | Round Grounding Prong |
| 5 | Neutral               |

- The dryer has a three-prong plug to help guard against shock. The plug should be plugged directed into a properly grounded three-prong receptacle that is rated 120 Volts AC (alternating current) 15 Amps. This plug, in order to be properly and fully effective, must be plugged into a properly installed outlet that is grounded in accordance with all local codes and ordinances.
- The dryer must be grounded in order to reduce the risk of electric shock, including a malfunction or breakdown.
- If your laundry room does not meet the specifications required by this manual, or if you are uncertain whether or not your laundry room meets these specifications, please have a qualified service person or company, for example a qualified electrician or your local electric company, review your laundry room's electrical supply for any problems.

#### ⚠ WARNING!

Do not overload the circuit by operating other appliances on the same circuit when this appliance is operating, by using an extension cord to connect the dryer to the power source, or by using any adapter to allow additional cords to connect to the same outlet.

#### ⚠ WARNING!

**DO NOT modify the plug provided with the dryer.** If it does not fit the outlet in your laundry room, a proper outlet will need to be installed in your laundry room by a qualified service person or company.

Following are important instructions and information concerning the requirements for the gas supply and service for gas dryers. **⚠ Important Warning:** The gas supply and service for a gas dryer must comply with all local codes and ordinances. In the absence of any local codes or ordinances in your area, the gas supply and service for your gas dryer must comply with the latest edition of the National Fuel Gas Code, ANSI Z223.1/NFPA 54.

1. Gas supply requirements: Liquefied Petroleum (L.P.) Gas (2,500 Btu/ft<sup>3</sup> (93.1 MJ/m<sup>3</sup>)) service must be provided at 10 + 1.5 in. water column pressure.
2. Do not attempt to connect Dryer to Liquefied Petroleum (LP Gas) Gas service without a qualified professional.
3. Isolate the dryer from the gas supply piping system by closing its individual manual shut-off valve, during any pressure testing of the gas supply system at test pressure equal to or less than 2/1 psi (3.45 kPa).
4. Supply Line Requirements. Your laundry room must have a rigid gas supply line to your dryer. In the United States, an individual manual shutoff valve **MUST** be installed within at least 6 feet (1.8m) of the dryer, in accordance with the National Fuel Gas Code ANSI Z223.1. A 1/8 in. N.P.T. pipe plug must be installed as shown.
5. If using a rigid pipe, the rigid pipe should be 1/2 inch IPS. If acceptable under local codes and ordinances and when acceptable to your gas supplier, 3/8 inch approved tubing may be used where lengths are less than 20 feet (6.1m). Larger tubing should be used for lengths in excess of 20 feet (6.1m). It is also important that you use pipe joint compound that is insoluble in LP gas.
6. To reduce the danger of gas leaks, explosion, and fire, please follow and observe the following **instructions and WARNINGS:**
  - Connect the dryer to the type of gas shown on the nameplate;
  - Use new flexible stainless steel connectors;
  - Use Teflon tape and pipe joint compound insoluble in LP gas on all pipe threads;
  - Purge gas supply of air and sediment before connecting the gas supply to the dryer; in order to prevent gas valve contamination, before tightening connection between gas supply and dryer, purge remaining air until odor of gas is identified; and
  - **DO NOT** use an open flame to inspect for gas leaks; instead, use a non-corrosive leak detection fluid.

### **WARNING!**

**DO NOT** attempt any disassembly of the dryer, any disassembly requires the attention and tools of an authorized and qualified service person or company.

### **WARNING!**

- Use a new AGA or CSA approved gas supply line.
- Install a shut-off valve.
- Securely tighten all gas connections.
- If connected to LP, have a qualified person make sure gas pressure does not exceed 13 in. water column.
- Examples of a qualified person include licensed heating personnel, authorized gas company personnel, and authorized service personnel.
- Failure to do so can result in death, explosion, or fire.

Following are important instructions and information concerning the exhaust requirements for your dryer.

**⚠ Important Warning:** To reduce the risk of fire, combustion, or accumulation of combustible gases, **DO NOT** exhaust dryer air into an enclosed and unventilated area, such as an attic, wall, ceiling, crawl space, chimney, gas vent, or concealed space of a building. To reduce the risk of fire, **DO NOT** exhaust the dryer with plastic or thin foil ducting.

| Weather Hood Type                                  | Number of 90° Elbows | Maximum length of 4" (10.2 cm) diameter rigid metal duct | Maximum length of 4" (10.2 cm) diameter flexible metal duct |
|----------------------------------------------------|----------------------|----------------------------------------------------------|-------------------------------------------------------------|
| <p><b>Recommended</b></p>                          | 0                    | 65 feet (19.8 m)                                         | 45 feet (13.7 m)                                            |
|                                                    | 1                    | 55 feet (16.8 m)                                         | 35 feet (10.7 m)                                            |
|                                                    | 2                    | 47 feet (14.3 m)                                         | 30 feet (9.1 m)                                             |
|                                                    | 3                    | 36 feet (11.0 m)                                         | 25 feet (7.6 m)                                             |
|                                                    | 4                    | 28 feet (8.5 m)                                          | 20 feet (6.1 m)                                             |
| <p><b>Use Only for Short Run Installations</b></p> | 0                    | 55 feet (16.8 m)                                         | 35 feet (10.7 m)                                            |
|                                                    | 1                    | 47 feet (14.3 m)                                         | 27 feet (8.2 m)                                             |
|                                                    | 2                    | 41 feet (12.5 m)                                         | 21 feet (6.4 m)                                             |
|                                                    | 3                    | 30 feet (9.1 m)                                          | 17 feet (5.2 m)                                             |
|                                                    | 4                    | 22 feet (6.7 m)                                          | 15 feet (4.5 m)                                             |

**NOTE :** Deduct 6 feet (1.8 m) for each additional elbow.  
It is not recommended to use more than 4 90° elbows.

**Exhaust Requirements and Instructions:**

- Venting materials are not provided with the dryer and you should obtain the necessary venting materials locally. For example, the outer end of exhaust pipe must have a weather hood with hinged dampers to prevent back-draft when the dryer is not in use.
- The exhaust duct must be four inches (10.2 cm) in diameter with no obstructions. The exhaust duct should be kept as short as possible. Make sure to clean any old ducts before installing your new dryer.
- Rigid metal duct is recommended. Do not install flexible duct in concealed spaces. Non-combustible flexible metal duct is acceptable. Do not use plastic or thin foil ducting.
- DO NOT** use sheet metal screws on exhaust pipe joints or other fastening means which extend into the duct that could catch lint and reduce the efficiency of the exhaust system. Secure all joints with duct tape.
- To maximize operating results, please observe the duct length limitations noted in the chart above.

### Exhaust and Dryer Maintenance



#### **WARNING!**

Disconnect the dryer's electric power prior to any cleaning or maintenance.

1. After one year of use, the interior and complete exhaust system of the dryer should be examined and cleaned if necessary.
2. Before one year of use, when drying performance has been suddenly unsatisfied in the past several cases, please examine and clean the exhaust duct for better drying performance.
3. Check the weather hoods frequently to ensure the dampers are moving freely, that the dampers are not pushed in and that nothing has been set against the dampers.
4. A qualified service person or company should be used to perform this maintenance.
5. A Flexible Metal Vent Kit, available at extra cost, can be used to exhaust the dryer when it is placed in hard to reach places. This Kit comes in two pieces, one of which is attached to the dryer and the other is attached to the wall exhaust outlet. Following attachment of the two separate pieces to the dryer and the wall, the dryer may be returned to its final position, after which the two pieces themselves can be connected.
7. Ordinarily, the dryer drum will need no care. Wipe the exterior of the dryer as required, and always immediately wipe the exterior of the dryer in the event any detergent, bleach, or other washing products is spilled on the dryer, because these products may cause permanent damage to the exterior finish of the dryer.
8. Clean the control panel with a damp cloth as necessary. Warning: spray pre-wash products may damage the finish of the control panel.
9. Please clean the lint filter either before drying each load or after drying each load.
10. Always make sure the lint filter is clean before starting a new load, because a clogged lint filter may increase drying times.
11. Annually remove the lint filter and attach it to the vacuum duct. See item #2 above.
12. Please note that the wiring diagram is provided inside the dryer control hood. Label all wires prior to disconnection when servicing the dryer, because wiring errors can cause serious injury to you and your dryer.

### Cleaning the Lint Screen

1. Clean the lint filter either before drying each load or after drying each load. Always make sure the lint filter is clean before starting a new load, because a clogged lint filter may increase drying times.
2. To clean, pull the lint screen straight up and roll any lint off the screen with your fingers. Do not rinse or wash screen to remove lint, because wet lint is hard to remove. Push the lint screen firmly back into place.
3. Always ensure the lint screen is firmly secured before running the dryer. Running the dryer with a loose lint screen may cause overheating and damage to the dryer and articles being dried.
4. Some articles of clothing may shed more lint than others (towels for example), causing the Lint Screen to rapidly fill. Remove lint from the lint screen before and after drying these articles, such as new towels.
5. In the event lint falls off of the lint screen and into the dryer during removal, inspect the exhaust hood and remove any lint.
6. Laundry detergent and fabric softener residue can build up on the lint screen, causing longer drying times. The screen is likely blocked if lint falls off the screen. In order to prevent this type of build up, and help ensure proper operation of your dryer, clean the lint screen with a nylon brush every six months or, if necessary, more frequently. The lint filter can also be washed as follows:
  - a) After rolling the lint off of the screen with your fingers, wet both sides of the screen with hot or warm water.
  - b) Wet a nylon brush with hot water and liquid detergent and scrub the lint screen with the brush to remove the buildup of detergent and fabric softener.
  - c) Repeat as necessary.
  - d) After the residue has been removed, rinse screen with hot water.
  - e) After drying the lint screen with a clean towel, firmly replace the lint screen in your dryer.

Following are instructions for starting and using your new dryer. Please refer to specific sections of this manual for more detailed information. Important Warning: To reduce the risk of fire, electric shock, or injury to person, read this entire manual, including the **Important Safety Instructions**, before operating this dryer.

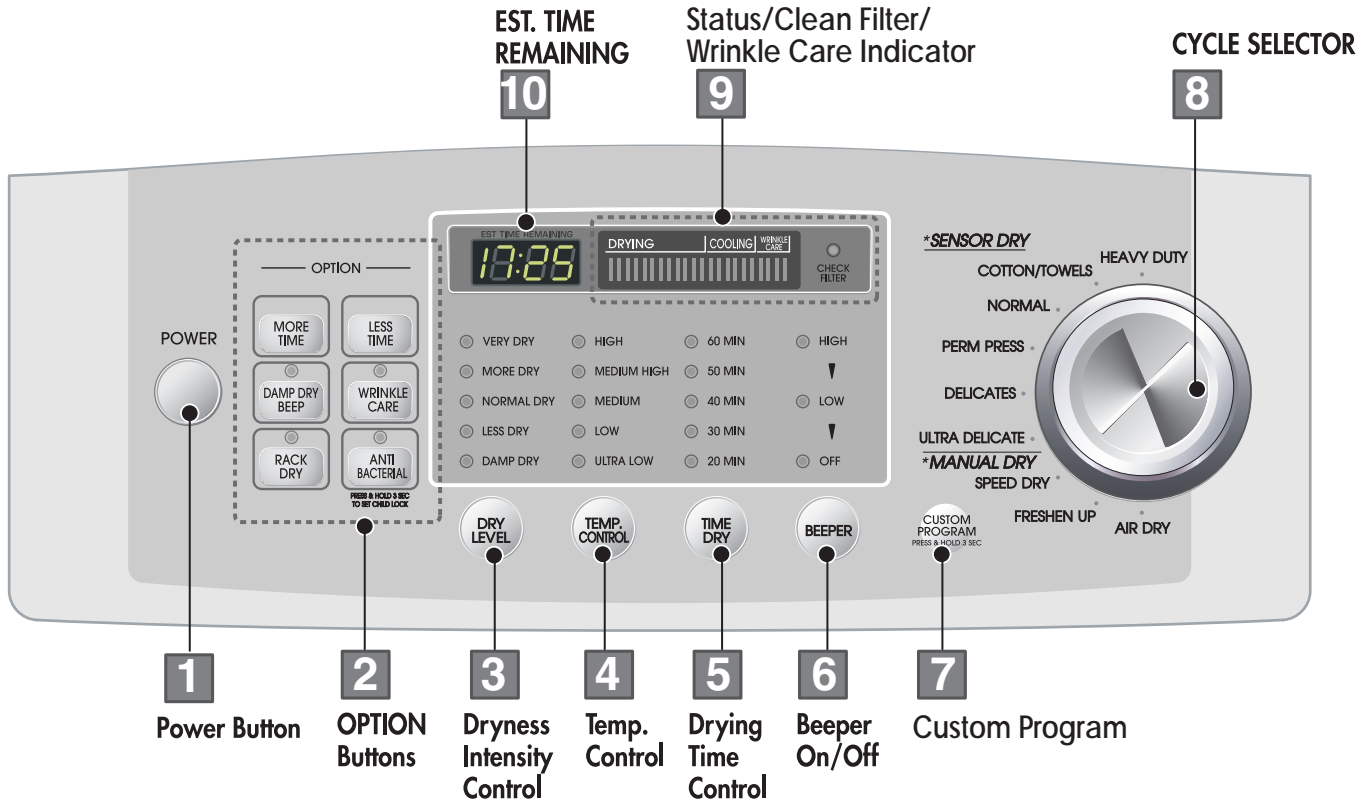

**1 Power Button**

- Use this button for power on or off.

**! WARNING!**

**Explosion Hazard**

Keep flammable materials and vapors, such as gasoline, away from dryer.  
Do not dry anything that has ever had anything flammable on it (even after washing). Failure to follow these instructions can result in death, explosion, or fire.

**! WARNING!**

**Fire Hazard**

No washer can completely remove oil. Do not dry anything that has ever had any type of oil on it (including cooking oils). Items containing foam, rubber, or plastic must be dried on a clothesline or by using an Air Dry Cycle. Failure to follow these instructions can result in death or fire.

**2 Option Button**

**1. More Time / Less Time**

- Press MORE TIME or LESS TIME until the desired drying time is set.

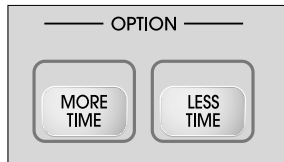

**Note**

Time change button is available only with Manual Dry, Time Dry and Rack Dry programs.

**2. Anti Bacterial**

This option reduces bacteria under high temperature during the cycle.

This option can only be used with the Heavy Duty, Cotton/Towels and Normal cycles.



● **Child Lock**

Child Lock can be used to prevent your children from undesirable use on control panel while the dryer is running.

When Child Lock is enabled, all the button will be locked and Child Lock glows.

To lock Child Lock, Press and hold Rack Dry for 3 seconds, A single beep tone is heard and CL is displayed on the status window.

To unlock Child Lock, press and hold Rack Dry for 3 seconds again.

**Note**

Do not use this cycle with delicate fabrics.

**3. Damp Dry Beep**

When you select the damp dry beep option, a beep will alert you when your load is approximately 80% dry.



This notice will allow you to remove lightweight items that are dry or other items that you may wish to iron.

**4. Wrinkle Care**

This option helps to prevent the wrinkle on your laundry.

When you select the wrinkle free option, the dryer will periodically tumble for up to three hours after the cycle has completed.

You can use this option in case that you can not remove laundry after drying is done.



**5. Rack Dry**

Rack Dry is designed for use with items which are not available for tumble drying such as sweaters, silk or lingerie. Sneakers also will be great with this option.



■ **To use the RACK DRY**

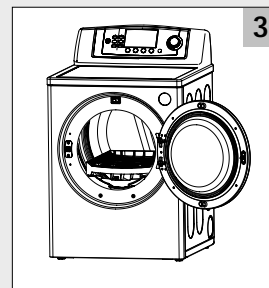
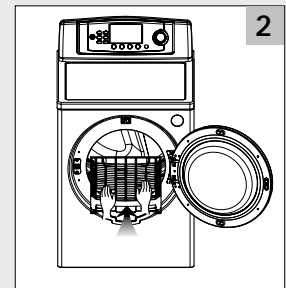
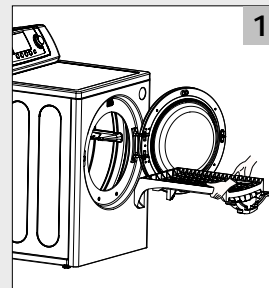

1. Open the door. Hold the dryer rack with both hands.
2. Put the dryer rack into the drum
3. Make sure Dryer RACK is evenly spaced right onto the drum inside and door rim.

**Note**

Don't use Rack for normal tumble drying. Rack Dry is shipped in place in your dryer so remove rack for normal laundry.

| Suggested Items for Rack Drying                     | Temperature Setting | Suggested Time* (Minutes) |
|-----------------------------------------------------|---------------------|---------------------------|
| Washable wool items                                 | Low                 | 20                        |
| Stuffed toys with cotton or polyester fiber filling | Low/Ultra Low       | 20/30                     |
| Stuffed toys, foam rubber filled.                   | Air Dry/ Ultra Low  | 50/30                     |
| Foam rubber pillows                                 | Air Dry             | 50                        |
| Athletic shoes                                      | Air Dry             | 20                        |

\* Reset time as needed to complete drying.

### 3 Dry Level



- Use this button to set dry level
- First, select sensor dry cycle.
- Select dry level to adjust how much you want to dry the load. As the cycle runs, the control senses the dryness of the load and adjusts the time automatically based on the selected dryness level.

#### Note

**DRY LEVEL** selections can only be made while using **Sensor Dry Cycles**. Selecting **MORE Dry** or **LESS Dry** automatically adjusts the needed time which is already sensed.

### 4 Temp. Control

Use Temp. Control Option to select temperatures for the Manual Cycles. Press **TEMP. CONTROL** until the desired temperature setting glows. Temperature modifiers cannot be used with the Sensor Dry Cycles.

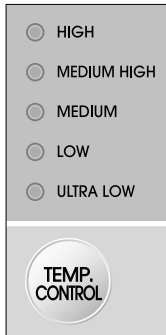

| Type of Load                                   | Default Time* (Minutes) |
|------------------------------------------------|-------------------------|
| Foam rubber-pillows, padded bras, stuffed toys | 20 - 30                 |
| Plastic-Shower curtains, tableclothes          | 20 - 30                 |
| Rubber-backed rugs                             | 40 - 50                 |
| Olefin, polypropylene, shear nylon             | 10 - 20                 |

### 5 Time Dry

Use Time Dry Option to change Drying Time on your own. You can select the desired operation time manually by pressing Time Dry button which ranges from 20 to 60 minutes.

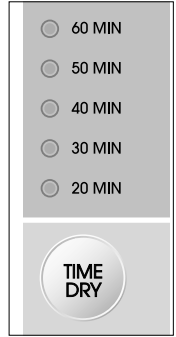

| Manual Preset Cycle Settings         |                    |                         |
|--------------------------------------|--------------------|-------------------------|
| Manual Dry Cycles Load Type          | Temp.              | Default Time* (Minutes) |
| <b>SPEED DRY</b><br>SMALL LOADS      | <b>High</b>        | <b>25</b>               |
| <b>FRESHEN UP</b><br>Remove Wrinkles | <b>Medium High</b> | <b>20</b>               |
| <b>AIR DRY</b>                       | <b>Air Dry</b>     | <b>30</b>               |

### 6 Beeper

The BEEPER controls the volume of the beep that is made when you press any of the buttons on the control panel and the termination of any cycle is indicated.

Press BEEPER to adjust the sound level or turn off the signal.

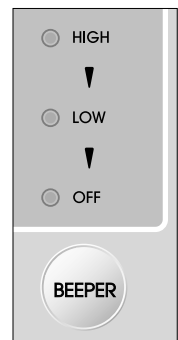

### 7 CUSTOM PROGRAM

Custom Programming Set up your favorite combination of settings and save them here for one-touch recall.



1. Select a cycle
2. Change DRY LEVEL and TEMP. CONTROL.
3. Select OPTIONS you want.
4. Press and hold the CUSTOM PROGRAM.

**To recall your stored CUSTOM PROGRAM**  
Press CUSTOM PROGRAM button, then press START/PAUSE.



**8 Cycle Selection**

- By dialing the knob, select the desired cycle based on laundry types and conditions.

**1. Sensor Dry Cycles**

Sensor Dry Cycles allow you to match the cycle to the load you are drying. Each cycle dries certain fabrics at the recommended temperature. A sensor detects the moisture in the load and automatically adjusts the drying time for optimal drying

**Heavy Duty**

Use this cycle to get high heat for heavy fabrics such as jeans, corduroys or work clothes

**Cotton/Towels**

Use for drying denims, towels, heavy cottons (medium-high heat)

**Normal**

Use for drying sturdy fabrics such as work casual clothes (medium heat)

**Perm press**

Use for permanent press and synthetic items (medium-heat)

**Delicates**

Use for drying synthetic fabrics, washable knit fabrics and no-iron finishes (low heat)

**Ultra Delicate**

Use to gently dry items such as workout wear, shear and lace items (extremely low heat)

| Sensor Dry Preset Cycle Settings                            |                    |                 |
|-------------------------------------------------------------|--------------------|-----------------|
| Sensor Dry Cycles Load Type                                 | Temp.              | Time* (Minutes) |
| <b>HEAVY DUTY</b><br>Jeans, heavyweight                     | <b>High</b>        | <b>54</b>       |
| <b>COTTON/TOWELS</b><br>Towel, denim pants                  | <b>Medium High</b> | <b>55</b>       |
| <b>NORMAL</b><br>Work clothes, corduroys                    | <b>Medium</b>      | <b>41</b>       |
| <b>PERM PRESS</b><br>Synthetics , permanent press           | <b>Low</b>         | <b>36</b>       |
| <b>DELICATES</b><br>Lingerie, sheets, blouses               | <b>Low</b>         | <b>32</b>       |
| <b>ULTRA DELICATE</b><br>Shear, workout wear and lace items | <b>Ultra Low</b>   | <b>34</b>       |

**2. Manual Dry Cycles**

Use Manual Cycles to select a specific amount of drying time and a drying temperature. When a Manual Cycle is selected, the ESTIMATED TIME REMAINING display shows the actual time remaining in your cycle. You can change the actual time in the cycle by pressing MORE TIME or LESS TIME.

**Speed Dry**

Use for small loads or loads that need a short drying time.

**Freshen Up**

Use this cycle to remove wrinkles from items, such as clothes packed in a suitcase or items wrinkled from being left in the dryer too long.

**Air Dry**

Use the Air Dry Modifier for items that require drying without heat such as rubber, plastic and heat-sensitive fabrics.

**9 Status/Clean Filter/Wrinkle Care Indicator**

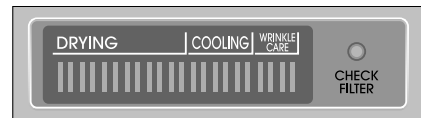

- It shows status of drying operation. When Wrinkle Care is selected, this option light will glow. When power is on, Clean Filter flashes until start/pause is selected.

**⚠ WARNING!**

For better drying performance and safety, clean lint filter every single use.

**10 Estimated Time Remaining**

- The Display shows the estimated time remaining. In addition to this, if the dryer has some problem, it displays error messages.



**Starting your dryer**

**1. Before use**

- Clean lint screen before or after each cycle.
- Place laundry into dryer and shut door. See Loading.
- Turn the knob to select the drying cycle you want. The preset setting for Sensor Dry Cycles or Manual Cycles will glow. The estimated or actual cycle time (in minutes) will show in the display.

**2. Loading**

- Determine load size by the amount of space the load requires rather than the weight of the load.
- Avoid overloading the dryer. Following these instruction can help reduce your utility bill, prolong the life of your clothes, and decrease the likelihood of uneven drying and wrinkle.

| Following are sample loads for Super Capacity Dryers:                                    |                                            |
|------------------------------------------------------------------------------------------|--------------------------------------------|
| <b>Heavy Work Clothes</b><br>4 jeans<br>4 workpants<br>4 work shirts                     | 2 sweatpants<br>2 sweatshirts              |
| <b>Cotton/Towels</b><br>10 bath towels<br>10 hand towels                                 | 14 wash cloths                             |
| <b>Mixed Load</b><br>3 sheets (1 king, 2 twin)<br>4 pillowcases<br>3 shirts<br>3 blouses | 9 T-shirts<br>9 shorts<br>10 handkerchiefs |

**3. To use a sensor dry cycle**

- **Select DRY LEVEL** to adjust how dry you want the load. As the cycle runs, the control senses the dryness of the load and adjusts the time automatically for the selected dryness level.
- **Select** the desired Options.
- **Press START/PAUSE**

**Note**

DRY LEVEL selections can only be made while using Sensor Dry Cycles. Selecting MORE Dry or LESS Dry automatically adjusts the sensed time needed.

**4. To use a sensor dry cycle**

- Select a Manual Dry Cycle.
- Press MORE TIME or LESS TIME until the desired drying time is displayed. Tap MORE TIME or LESS TIME and the time will change by 1 minute interval.

**Note**

The MORE TIME or LESS TIME feature can be used with Manual Dry, Time Dry and Rack Dry Cycles.

- Press TEMP. CONTROL until the desired temperature indicator glows.
- (OPTIONAL STEP) If desired, select OPTIONS.

**For more details, see Options.**

- Press START/PAUSE. Be sure the door is closed.
- If you do not press START/PAUSE within 10 minutes of selecting the cycle, the dryer automatically shuts off.
- If you wish to end your drying cycle after pressing START/PAUSE, press START/PAUSE again.

**To stop your dryer at any time**

Press START/PAUSE or open the door.

**5. Pausing or restarting To pause the dryer at any time**

Open the door or press START/PAUSE once.

**To restart the dryer**

Close the door. Press START/PAUSE.

**Note**

Drying will continue from where the cycle was interrupted if you close the door and press START within 10 minutes. If the cycle is interrupted for more than 10 minutes, the dryer will shut off. Select new cycle settings before restarting the dryer.

**⚠ WARNING!**

Improper wire connection or related wiring error will can cause fire or electric shock or death.

## Maintenance

### Clean lint filter

Clean the lint filter after each use and check it before use. Not cleaning or emptying the filter will increase drying time and energy consumption, therefore dryer life expectancy could be shortened after all.

#### ■ Clean the door and its opening

1. Wipe out the door opening. Otherwise, build-ups of dirty and foreign objects will damage sealing of door.

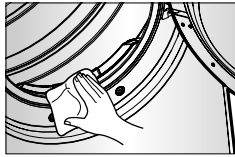

2. Clean the transparent glass door to keep inside view clear through the glass.

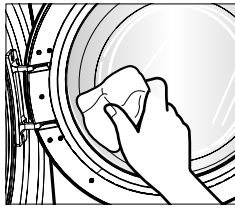

1. Open the door and pull the filter straight up



2. Clean the filter using one of following ways in cases.

- ① Run the fingers across the filter

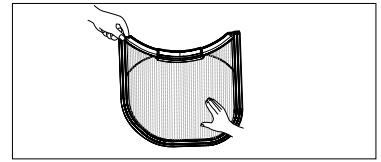

- ② Vacuum the lint filter

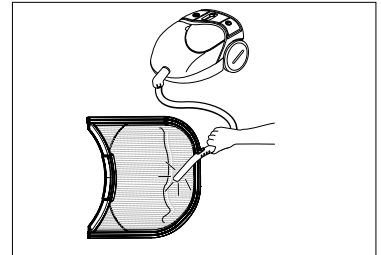

- ③ Wash the lint screen in warm, soapy water. Dry thoroughly and replace.

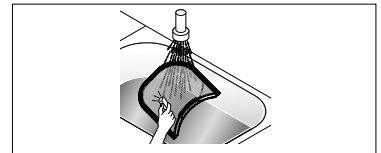

## Troubleshooting Tips

Save time and money! Review the charts on the following pages first and you may not need to call for service.

## 1.Problem:My Dryer Won 't Start

| Question                                                | What to Do                                                                                                                                                                            |
|---------------------------------------------------------|---------------------------------------------------------------------------------------------------------------------------------------------------------------------------------------|
| • Is the dryer plugged in?                              | Confirm that the dryer's plug is securely and completely pushed into the laundry room's power outlet                                                                                  |
| • Is the fuse blown, or is the circuit breaker tripped? | Check your home's or laundry room's fuse box/circuit breaker box and replace the fuse or reset the circuit breaker. (IMPORTANT: electric dryers generally use two fuses or breakers.) |

## 2.Problem:My Dryer Doesn 't Heat

| Question                                                | What to Do                                                                                                                                                                                                                                                                        |
|---------------------------------------------------------|-----------------------------------------------------------------------------------------------------------------------------------------------------------------------------------------------------------------------------------------------------------------------------------|
| • Is the fuse blown, or is the circuit breaker tripped? | If the fuse is blown or the circuit breaker tripped, the dryer might tumble but not heat. Check your home's or laundry room's fuse box / circuit breaker box and replace the fuse or reset the circuit breaker. (IMPORTANT: electric dryers generally use two fuses or breakers.) |
| • Is the gas supply or service blocked or off?          | Confirm that the house gas shutoff and the dryer gas shutoff are both fully open.                                                                                                                                                                                                 |

## 3.Problem:There are Greasy Spots on My Clothes

| Question                                                           | What to Do                                                                                                                                                                                                                  |
|--------------------------------------------------------------------|-----------------------------------------------------------------------------------------------------------------------------------------------------------------------------------------------------------------------------|
| • Did you follow the instructions on your fabric softener product? | Confirm and follow the instructions provided with your fabric softener product.                                                                                                                                             |
| • Are you drying clean and dirty clothes together?                 | Make sure to use your dryer to dry only clean items, because dirty items can soil clean clothes placed in the same load or later placed in the dryer drum.                                                                  |
| • Were your clothes entirely clean?                                | Stains on dried clothes are actually stains that weren't cleansed during the washing process. Please review and confirm that you are following your washing instructions and that the clothes are being completely cleaned. |

**4.Problem:There is Lint on my Clothes**

| Question                                                                  | What to Do                                                                                                                                                                                                                                                                                                        |
|---------------------------------------------------------------------------|-------------------------------------------------------------------------------------------------------------------------------------------------------------------------------------------------------------------------------------------------------------------------------------------------------------------|
| • Is your lint filter full?                                               | Please refer to the manual section on cleaning the lint filter, and please confirm that the lint filter is clean. It is important that the lint filter is clean before each new load of laundry.                                                                                                                  |
| • Did you properly sort your load of laundry?                             | In order to reduce the amount of lint in a load of laundry, sort lint producers (like a fuzzy white cotton towel) separately from clothes that might catch lint (such as a pair of black linen pants).                                                                                                            |
| • Do your clothes have excess static electricity?                         | See comments below under There is static in my clothes after drying.                                                                                                                                                                                                                                              |
| • Did you overload your dryer?                                            | Divide your larger load into smaller loads.                                                                                                                                                                                                                                                                       |
| • Did you place any paper, tissue, or other similar material in the load? | Sometimes a person might forget to take a piece of paper or a tissue out of the pocket of a pair of pants, and this paper, tissue, or similar material can cause excess lint in a load of laundry. Confirm that the pockets of pants, shirts, and other articles of clothing are empty before washing and drying. |

**5.Problem:There is static in my clothes after drying**

| Question                                                | What to Do                                                                                                                                                   |
|---------------------------------------------------------|--------------------------------------------------------------------------------------------------------------------------------------------------------------|
| • Did you use fabric softener?                          | Try using a fabric softener to reduce static electricity.                                                                                                    |
| • Did you over dry the load of laundry?                 | Over-drying a load of laundry can cause a build up of static electricity. Try using a fabric softener or adjust your settings and use a shorter drying time. |
| • Are you drying synthetic, permanent press and blends? | These materials can cause static to build up in a load of dried clothes. Try using a fabric softener.                                                        |

**6.Problem:The drying time is not consistent**

| Question                                                            | What to Do                                                                                                                                                                                                                                            |
|---------------------------------------------------------------------|-------------------------------------------------------------------------------------------------------------------------------------------------------------------------------------------------------------------------------------------------------|
| • Are you using consistent heat settings and consistent load sizes? | The drying time for a load will vary depending on the heat setting, the type of heat used (electric, natural or LP gas), the size of the load, the type of fabrics, the wetness of the clothes and the condition of the exhaust ducts and lint filer. |

**7.Problem:It takes too long for my clothes to dry**

| Question                                                    | What to Do                                                                                                                                                                                                                                                                                                                    |
|-------------------------------------------------------------|-------------------------------------------------------------------------------------------------------------------------------------------------------------------------------------------------------------------------------------------------------------------------------------------------------------------------------|
| • Did you properly sort your loads of laundry?              | Separate heavy weight items from light weight items when creating loads.                                                                                                                                                                                                                                                      |
| • Are you drying large loads of heavy fabrics?              | Heavy fabrics take longer to dry because they tend to retain more moisture. To help reduce and maintain more consistent drying times for large and heavy fabrics, separate these items into smaller loads of a consistent size.                                                                                               |
| • Are the dryer controls properly set?                      | Use the appropriate control settings for the type of load you are drying.                                                                                                                                                                                                                                                     |
| • Is the lint filter clean before each new load of laundry? | Please confirm that the lint filter is clean prior to each new load of laundry.                                                                                                                                                                                                                                               |
| • Are the exhaust ducts clear and properly configured?      | Confirm through review of the appropriate sections of this manual that the exhaust venting ductwork is properly configured. Confirm that the venting is free of obstructions. Confirm that the outside wall dampers are moving freely, that the dampers are not pushed in, and that nothing has been set against the dampers. |
| • Is the fuse blown, or is the circuit breaker tripped?     | Check your home's or laundry room's fuse box/circuit breaker box and replace the fuse or reset the circuit breaker. (IMPORTANT: electric dryers generally use two fuses or breakers.)                                                                                                                                         |
| • Did you overload your dryer?                              | Divide your larger load into a number of smaller loads.                                                                                                                                                                                                                                                                       |
| • Did you under load your dryer?                            | If you are only drying a handful of items, add a few extra pieces to help ensure proper tumbling action.                                                                                                                                                                                                                      |

**8.Problem:My clothes are wrinkled**

| Question                                                                                | What to Do                                                                                                                                                   |
|-----------------------------------------------------------------------------------------|--------------------------------------------------------------------------------------------------------------------------------------------------------------|
| • Are you over drying your laundry?                                                     | Over drying a load of laundry can lead to wrinkled clothes. Try a shorter drying time, and remove items while they still retain a slight amount of moisture. |
| • Are you removing your laundry from the dryer soon after the drying cycle is complete? | Remove your laundry from the dryer after the drying cycle ends and either hang or fold the items.                                                            |

**9.Problem:My clothes are shrinking**

| Question                                                    | What to Do                                                                                                                                                                                                             |
|-------------------------------------------------------------|------------------------------------------------------------------------------------------------------------------------------------------------------------------------------------------------------------------------|
| • Are you following the care instructions for your garment? | To avoid shrinkage, please carefully follow the care and use instructions for your garment, because some fabrics will naturally shrink when washed. Other fabrics can be washed but will shrink when dried in a dryer. |
| • PLM problem                                               | See the Owner's Manual of RLM & PLC modem.                                                                                                                                                                             |

# LG DRYER LIMITED WARRANTY – USA

LG Electronics Inc. will repair or at its option replace, without charge, your product if it proves to be defective in material or workmanship under normal use during the warranty period set forth below, effective from the date of original consumer purchase of the product. This limited warranty is good only to the original purchaser of the product and effective only when used in the United States including Alaska, Hawaii, and U.S. Territories.

|                                                                                                                                                         |                                                                                                                                                                                                                                                                                                                      |
|---------------------------------------------------------------------------------------------------------------------------------------------------------|----------------------------------------------------------------------------------------------------------------------------------------------------------------------------------------------------------------------------------------------------------------------------------------------------------------------|
| <p><b><u>WARRANTY PERIOD:</u></b></p> <p><b>Labor: 1 Year</b> from the Date of Purchase.</p> <p><b>All Parts: 1 Year</b> from the Date of Purchase.</p> | <p><b><u>HOW SERVICE IS HANDLED:</u></b></p> <p>Call 1-800-243-0000 and choose the appropriate prompt. Please have product type (Dryer), model number, serial number, and ZIP code ready.</p> <p>The warranted 1-year of labor covers the cost of In-Home Service on all parts including the Drum Tub and Motor.</p> |
|---------------------------------------------------------------------------------------------------------------------------------------------------------|----------------------------------------------------------------------------------------------------------------------------------------------------------------------------------------------------------------------------------------------------------------------------------------------------------------------|

**THIS WARRANTY IS IN LIEU OF ANY OTHER WARRANTIES, EXPRESS OR IMPLIED, INCLUDING WITHOUT LIMITATION, ANY WARRANTY OF MERCHANTABILITY OR FITNESS FOR A PARTICULAR PURPOSE. TO THE EXTENT ANY IMPLIED WARRANTY IS REQUIRED BY LAW, IT IS LIMITED IN DURATION TO THE EXPRESS WARRANTY PERIOD ABOVE. LG WILL NOT BE LIABLE FOR ANY CONSEQUENTIAL, INDIRECT, OR INCIDENTAL DAMAGES OF ANY KIND, INCLUDING LOST REVENUES OR PROFITS, IN CONNECTION WITH THE PRODUCT. SOME STATES DO NOT ALLOW LIMITATION ON HOW LONG AN IMPLIED WARRANTY LASTS OR THE EXCLUSION OF INCIDENTAL OR CONSEQUENTIAL DAMAGES, SO THE ABOVE LIMITATIONS OR EXCLUSIONS MAY NOT APPLY TO YOU.**

**THIS LIMITED WARRANTY DOES NOT APPLY TO:**

1. Service trips to your home to deliver, pick up, and/or install the product, instruct, or replace house fuses or correct wiring, or correction of unauthorized repairs; and
2. Damages or operating problems that result from misuse, abuse, operation outside environmental specifications or contrary to the requirements or precautions in the Operating Guide, accident, vermin, fire, flood, improper installation, acts of God, unauthorized modification or alteration, incorrect electrical current or voltage, or commercial use, or use for other than intended purpose.
3. Therefore, the cost of repair or replacement of such a defective product shall be borne by the consumer.

**CUSTOMER INTER-ACTIVE CENTER NUMBERS:**

|                                                                                                                                  |                                                                                                                                                                                                                                                                                            |
|----------------------------------------------------------------------------------------------------------------------------------|--------------------------------------------------------------------------------------------------------------------------------------------------------------------------------------------------------------------------------------------------------------------------------------------|
| <p><b>To Prove Warranty Coverage</b></p>                                                                                         | <p><b>Retain your Sales Receipt to prove date of purchase.</b> A copy of your Sales Receipt must be submitted at the time warranty service is provided.</p>                                                                                                                                |
| <p><b>To Obtain Nearest Authorized Service Center or Sales Dealer, or to Obtain Product, Customer, or Service Assistance</b></p> | <p><b>Call 1-800-243-0000</b> (24 hrs a day, 7 days per week) and choose the appropriate prompt from the menu, and have your product type (Dryer), model number, serial number, and ZIP Code; or visit our website at <a href="http://www.lgservice.com">http://www.lgservice.com</a>.</p> |