



SINCE 1906
MANUFACTURING COMPANY
 585 KUMPF DRIVE LIMITED
 WATERLOO, ONTARIO, CANADA

GAS BARBECUES

OWNER'S MANUAL

For Models 285164, 585964, 785164, 286164, 586164,
 746164, 786164, 286184, 586184, 746184, 746189

FOR USE WITH L.P. GAS
 (LIQUIFIED PETROLEUM GAS) IN CANADA -
 PROPANE GAS

CONTENTS

SAFETY 2

INSTALLATION..... 2

L.P. GAS CYLINDER 3

OPD EQUIPPED CYLINDER..... 4

HOSE & REGULATOR 4

LEAK TESTING 5

VENTURI TUBES..... 5

LIGHTING 6

OPERATION 7

COOKING TECHNIQUES..... 7

MAINTENANCE..... 10

TROUBLE SHOOTING..... 11

WARRANTY..... 12



ANSI Z28.58b-2006 / CSA 1.6b-2006

Please record your model and serial number here.
 This information is located on the lower base.

Model Number

Serial Number

Date of Purchase

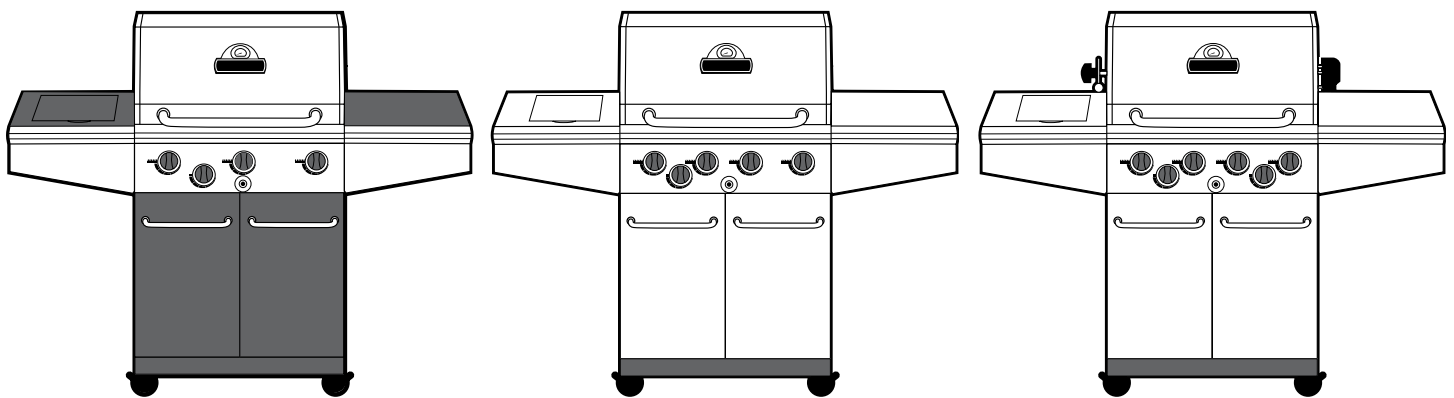

READ ALL INSTRUCTIONS CAREFULLY BEFORE OPERATING YOUR GAS BARBECUE
RETAIN THESE INSTRUCTIONS FOR FUTURE REFERENCE



Questions, problems, missing parts? Before returning to your retailer, call our customer service department at
 1-800-265-2150, 8 a.m.- 5 p.m., EST, Monday-Friday. info@omcbbq.com

11412268 LP
 Rev. A 2/20/08

SAFETY

Your new Kenmore gas grill is a safe, convenient appliance when assembled and used properly. However, as with all gas-fired products, certain safeguards must be observed. **Failure to follow these safeguards may result in damage or injury.** If you have questions concerning assembly or operation, consult your dealer, gas appliance serviceman, your gas company or our direct customer service line at 800-265-2150.

FOR YOUR SAFETY

- * If you smell gas:
 1. Shut off gas to the appliance.
 2. Extinguish any open flame.
 3. Open lid.
 4. If odour continues, immediately call your gas supplier or your fire department.

DO NOT store or use gasoline, or other flammable vapours and liquids in the vicinity of this or any other appliance.

An LP cylinder not connected for use shall not be stored in the vicinity of this or any other appliance.

CAUTION

- * **FOR OUTDOOR USE ONLY.**
- * **IF STORED INDOORS, DETACH AND LEAVE CYLINDER OUTDOORS.**
- * **THIS APPLIANCE MUST NOT BE OPERATED UNATTENDED.**
- * **SPECIAL CARE MUST BE TAKEN TO KEEP SMALL CHILDREN AWAY FROM HEATED SURFACES.**

Use caution when handling or transporting this product. Metal edges can present a hazard. Use appropriate gloves when lifting or handling. Before lifting, remove side shelves and grids and grates.

ELECTRICAL CAUTION

1. If any accessory is used on this appliance that requires an external electrical power source, the accessory when installed must be electrically grounded in accordance with local codes. In the absence of local codes, the following standards apply:
 - (U.S.A.) **ANSI/NFPA No. 70-Latest Edition**
 - and**
 - (CANADA) **CSA C22.1 Canadian Electrical Code**
2. Do not cut or remove the grounding prong from the plug.
3. Keep the electrical supply cord and fuel supply hose away from any heated surface.

INSTALLATION

WARNING

Fuels used in gas or oil-fired appliances, and the products of combustion of such fuels, contain chemicals known to the State of California to cause cancer, birth defects or other reproductive harm.

"This warning is issued pursuant to California Health and Safety Code Sec. 25249.6"

1. In the U.S.A., this appliance must be installed in accordance with the local code and the relevant national code.

ANSI Z223.1/NFPA 54 - Latest Edition National Fuel Gas Code and Latest Local Codes where Applicable

In Canada, this appliance must be installed in accordance with the local code and the relevant CSA standards:

CSA-B149.1 Natural Gas and Propane Installation Code

2. The appliance must be located away from combustible surfaces by at least 76cm/30" from each side, and 76cm/30" from the rear.

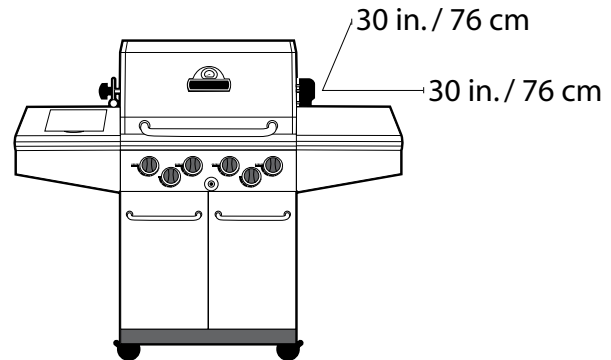

3. **DO NOT** operate this appliance under any overhead roof construction or foliage.
4. This appliance is for **OUTDOOR USE ONLY, DO NOT** operate in garage, shed, balcony or other such enclosed areas.
5. **DO NOT** restrict the flow of air to the appliance.
6. Keep the area surrounding the appliance free of combustible materials, gasoline, and all flammable liquids and vapours.
7. This appliance is not intended to be installed in, or on, recreational vehicles and/or boats.

LP GAS CYLINDER PLACEMENT

8. Cylinders must be installed according to assembly instructions using retainer provided. Do not store a spare cylinder under or near this appliance.

LP GAS CYLINDER

QCC®-1 QUICK CLOSING COUPLING

All models are designed to be used with an LP gas cylinder equipped with the new QCC®-1 Quick Closing Coupling system.

The QCC®-1 system incorporates new safety features required by the American National Standards Institute (ANSI) and the Canadian Standards Steering Committee.

- * Gas will not flow until a positive connection has been made.
- * A thermal element will shut off the flow of gas between 240° and 300° F.
- * When activated, a Flow Limiting Device will limit the flow of gas to 10 cubic feet per hour.

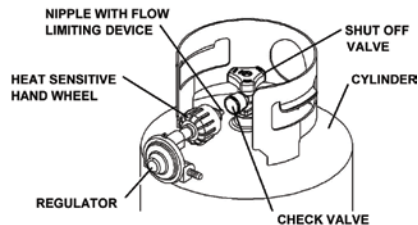

The LP Gas Cylinder is not included with the Gas Grill. Be sure to purchase one with the QCC® valve. This valve is recognized by the external threads on the inlet port of the valve. QCC® equipped cylinders are available from your Gas Grill Dealer.

Any attempt to connect the regulator, by use of adapters or any other means, to any other valve could result in damage, fire or injury and may negate the important safety features designed into the QCC®-1 system.

SPECIFICATION:

1. All LP gas cylinders used with this appliance must be constructed and marked in accordance with the *Specifications for LP Gas Cylinders* of the U.S. Department of Transportation (D.O.T.) or the *National Standard of Canada, CAN/CSA-B339, Cylinders, Spheres and Tubes for Transportation of Dangerous Goods; and Commission*, as applicable; and
2. The LP gas cylinder used for this appliance must not have a capacity larger than 20 lb. (9 kg).
Approximately 18" (46cm) high
12" (31cm) diameter
3. All LP gas cylinders used with this appliance should be inspected at every filling and re qualified by a licensed service outlet at the expiry date (10 years), in accordance with the DOT (USA) and CTC (Canada) codes for LP Gas Cylinders.
4. All LP gas cylinders used with this appliance must be provided with a shutoff valve terminating in a cylinder valve outlet No. 510, specified in the Standard for Compressed Gas Cylinder Valve Outlet and Inlet Connection (USA) ANSI/CGA-V-1-1977 (Canada) CSA B96.

The cylinder supply system must be arranged for vapor withdrawal. The cylinder must include a collar to protect the cylinder valve. The cylinder must be installed as per assembly instructions. Never fill the cylinder beyond

80% full. A fire causing death or serious injury may occur. The cylinder valve must include a safety relief device having direct communication with the vapor space of the cylinder.

HANDLING:

1. Government regulations prohibit shipping full LP gas cylinders. You must take your new cylinder to a LP gas dealer for filling.
2. A filled LP gas cylinder is under very high pressure. Always handle carefully and transport in the upright position. Protect the valve from accidental damage.
3. Do not tip the LP gas cylinder while connecting it to the regulator. Fasten the cylinder securely during transport, use and storage.
4. If the cylinder is tipped after it is connected to the regulator, shut off the gas, disconnect the regulator and have it checked before using again.

STORAGE:

1. Store the LP gas cylinder outdoors in a well ventilated place.
2. Do not store the LP gas cylinder in direct sunlight, near a source of heat or combustion.
3. If you intend to store the grill indoors, disconnect and remove the LP gas cylinder first. Disconnected cylinders must have a dust cap installed and must not be stored in a building, garage or any other enclosed area.
4. Keep out of the reach of children.
5. When the LP gas cylinder is connected to the gas grill, the gas grill and LP gas cylinder must be stored outside in a well ventilated place.

OPERATION:

1. Never connect your gas grill to an LP gas cylinder without the regulator provided, and **NEVER TO AN UNREGULATED LP GAS SUPPLY**. The gas regulator supplied with the appliance must be used.
2. **Always** leak test the LP gas cylinder to regulator connection when connecting the LP gas cylinder to the appliance. See "Leak Testing".
3. **DO NOT** operate appliance if the smell of LP gas is present. Extinguish all flame and determine source of LP gas before proceeding. **DO NOT** ignite the appliance until the LP gas leak has been found and sealed.
4. **Always** shut off LP gas cylinder valve when the appliance is not in use.

OPD EQUIPPED CYLINDER

OVERFILL PREVENTION DEVICE

The standard for outdoor gas appliances, ANSI Z21.58/ CAN/CGA-1.6, requires that appliances are to be used with cylinders equipped with an Overfill Prevention Device (OPD).

The OPD is designed to reduce the potential for the overfilling of propane cylinders, thus reducing the possibility of relief valve discharges of raw propane. The OPD causes a slower purge/fill operation. Some consumers have been advised by filling stations that these cylinders are “defective”. This is not a defect. Some propane filling stations may not be aware of this new device and its effect on the purge/fill operation.

New OPDs coming onto the market have new technology that allows for much greater BTU outputs which will decrease the amount of time it takes to purge a cylinder.

IDENTIFICATION

To identify these cylinders, the new OPD handwheel has been standardized to the shape shown.

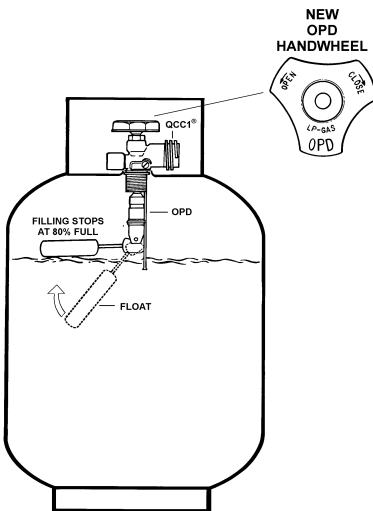

All models are equipped with a hose and regulator with a QCC®-1 Quick Closing Coupling.

1. The QCC® coupling contains a magnetic Flow Limiting Device which will limit the flow of gas should there be a leak between the regulator and the appliance valve. This device will activate if the cylinder valve is opened while the appliance valves are open. Be sure the appliance valves are off before the cylinder valve is opened to prevent accidental activation.
2. The QCC® coupling incorporates a heat sensitive hand wheel that will cause the back check module in the QCC® cylinder valve to close when exposed to temperatures between 240° and 300°F. Should this occur, do not attempt to reconnect the nut. Remove hose/ regulator assembly and replace with a new one.

HOSE & REGULATOR

3. The pressure regulator is set at 11 inches WC (water column) and is for use with LP gas only. The hose and hose couplings comply with CGA Standard CAN 1.83. No modifications or substitutions should be attempted.
4. Protect the hose from dripping grease and do not allow the hose to touch any hot surface, including the base casting of the barbecue.
5. Inspect seal in the QCC® cylinder valve when replacing LP gas cylinder or once per year whichever is more frequent. Replace seal if there is any indication of cracks, creases, or abrasion.
6. Inspect hose before each use of the barbecue. If the hose is cracked, cut, abraded or damaged in any way, the appliance must not be operated.
7. For repair or replacement of hose/regulator assembly, contact customer service at 1-800-265-2150 or info@omcbbq.com.

CONNECTION

1. Be sure cylinder valve and appliance valves are off.

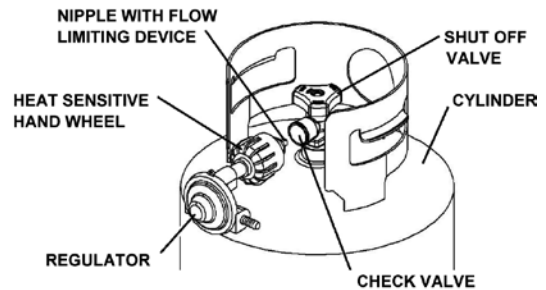

2. Place full LP gas cylinder in LP tank well and secure base as per assembly instructions.
3. Center the nipple in the cylinder valve and hold in place. Using other hand, turn the hand wheel clockwise until there is a positive stop. Do not use tools. Hand tighten only. When making the connection, hold the regulator in a straight line with the cylinder valve, so as not to cross thread the connection.
4. Leak test connections. See “Leak Testing”.
5. Refer to lighting instructions. To avoid activating the Flow Limiting Device when lighting, open cylinder valve slowly with the appliance valves off. If the Flow Limiting Device is accidentally activated, turn off cylinder valve and appliance valves, wait 10 seconds to allow the device to reset, open cylinder valve slowly, then open the appliance valve.

LEAK TESTING

All factory-made connections have been thoroughly tested for gas leaks. However, shipping and handling may have loosened a gas fitting.

AS A SAFETY PRECAUTION:

- * **TEST ALL FITTINGS FOR LEAKS BEFORE USING YOUR GAS BARBECUE.**
- * **TEST THE CYLINDER VALVE FOR LEAKS EACH TIME THE CYLINDER IS FILLED.**
- * **TEST FOR LEAKS EVERY TIME YOU CONNECT A GAS FITTING.**
- * **DO NOT SMOKE!**
- * **NEVER TEST FOR LEAKS WITH A LIGHTED MATCH OR OPEN FLAME.**
- * **TEST FOR LEAKS OUTDOORS.**

TO TEST FOR LEAKS:

1. Extinguish any open flame or cigarettes in the area.
 2. Be sure that cylinder valve and appliance valves are off
 3. Connect LP gas cylinder. See "Hose and Regulator".
 4. Prepare a soap solution of one part water, one part liquid detergent.
 5. With a full gas cylinder, open cylinder slowly.
 6. Brush the soap solution on each connection.
- If your barbecue is equipped with a side burner or rear burner:
- a. Place finger tip over the opening in the orifice at the end of hose.
 - b. Turn "SIDE"/"REAR" control to "HI".
 - c. Brush soap solution on each connection between orifice and control valve.
 - d. Turn "SIDE"/"REAR" control to "OFF".
7. A leak is identified by a flow of bubbles from the area of the leak.

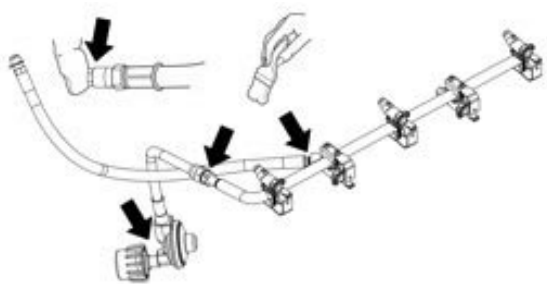

8. If a leak is detected, close the gas cylinder "shut-off" valve, tighten the connection and retest (Step 5).
9. If the leak persists, contact your barbecue dealer for assistance. Do not attempt to operate appliance if a leak is present.

VENTURI TUBES

- * **KEEP VENTURI TUBES CLEAN.**
- * **Blockages caused by spiders insects and nests can cause a flashback fire.**

Although the barbecue might still light, the backed up gas might also ignite and cause a fire around the venturi tubes at the control panel or side burner.

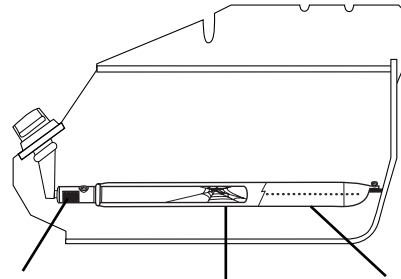

VENTURI TUBE SPIDER WEB TUBE BURNER

- * **If a flashback fire occurs, turn off gas at the source immediately**

Inspect and clean the venturi tubes (main burner, side burner, rear burner) if any of the following symptoms occur:

1. You smell gas.
2. Your barbecue does not reach temperature.
3. Your barbecue heats unevenly.
4. The burners make popping noises.

INSPECTING & CLEANING VENTURI TUBES

1. Turn off gas at the source. i.e. the gas cylinder or supply line for natural gas.
2. When barbecue is cool, remove the top portion of the collector boxes and lift the burner from the barbecue housing.

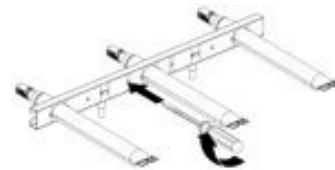

3. Clean the venturi tubes with a pipe cleaner or venturi cleaning tool.

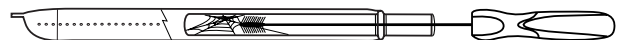

4. Lower the burner into position in the barbecue housing, making sure that the venturi tubes are correctly aligned and fitted on the orifices.

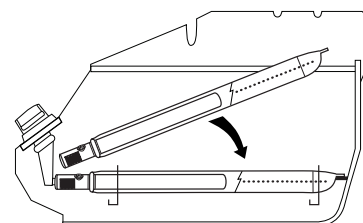

5. Secure burner with burner fasteners.
6. Snap top portion of collector boxes in place.

LIGHTING

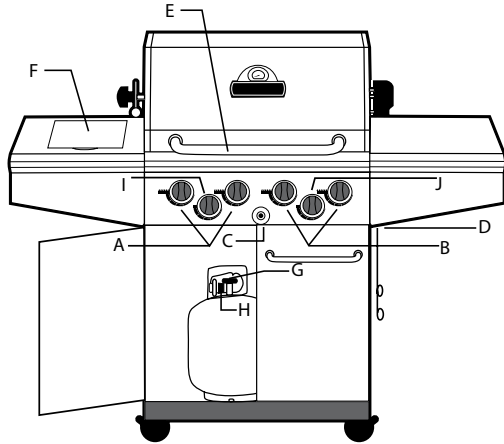

- | | |
|---------------------------------|------------------------|
| A. MAIN BURNER CONTROLS - LEFT | E. HANDLE |
| B. MAIN BURNER CONTROLS - RIGHT | F. SIDE BURNER |
| C. IGNITOR | G. CYLINDER VALVE |
| D. MANUAL LIGHTING HOLE | H. REGULATOR |
| | I. SIDE BURNER CONTROL |
| | J. REAR BURNER CONTROL |

- The appliance must be assembled as per the assembly instructions.
- Check that your gas cylinder is full and properly connected to the regulator.
- Check that there are no gas leaks in the gas supply system. See "Leak Testing".
- Check that the venturi tubes are properly located over the gas valve orifices.
- Check that both Main Burner and Side Burner ignition wires are connected.
- Read carefully all instructions contained on the information plate attached to the barbecue.
- WARNING:** Open lid before lighting.
- Set control knobs to "OFF" and turn on the gas supply.
- a. For Main Burner:
Check that the battery has been installed into the electronic ignition. Push and turn one main burner control knob to "HIGH". Push and hold down the ignitor button or match light.
Burner should ignite within 5 seconds.

Note: To light burner with a match follow steps 1 thru 8 above. Insert lighted match through lighting hole located at the bottom right of the grill housing using the match holder provided with your appliance. Push and turn right control knob to "HIGH". Burner should ignite within 5 seconds.

After the first burner is lit, push and turn the other main burner control knobs to "HIGH". Other burners will ignite automatically.

- b. For Side Burner:
Push and turn control knob to "HIGH".
Push and hold the ignitor button.
Burner should ignite within 5 seconds.
Note: To light burner with a match follow steps 1 thru 8 above.
Apply lighted match to burner ports.

- Push in the control knob and turn to "HIGH".
Burner should ignite within 5 seconds.
- c. For Infrared Rear Burner Rotisserie:
WARNING: Do not operate the main burner simultaneously with the rear burner as this may result in a grease fire and/ or damage to the barbecue.
Remove the warming rack:
Follow steps 1 thru 8.
Push and hold the ignitor button.
When pushing the igniter, a flash of flames moving across the rear burner surface will appear. Burner should ignite within 5 seconds.
The Infrared Rear Burner will glow RED once the burner is fully ignited. This will take 1 – 2 minutes of continuous burning.
Note: To light burner with a match follow steps 1 thru 8 above. It is important to have lighted match near burner ports **BEFORE** turning the control knob.
CAUTION – The rear burner may be difficult to see on a bright day.
 10. **CAUTION** - Check your barbecue after lighting.

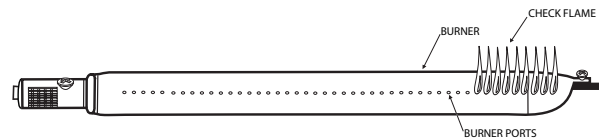

All the ports on the burner should show a 2.5cm flame on "HIGH" setting.

If any of the following symptoms occur there is probably a blockage in the venturi tubes. Shut off gas at once and clean the venturi tubes. See "Venturi Tubes".

- You smell gas.
- If a flashback fire occurs.
- Your barbecue heats unevenly.
- The burners make popping noises.

- IF BURNER DOES NOT IGNITE:**
- Push and turn control knob to "OFF".
Wait 5 minutes, then try again with right control knob or both control knobs set at medium.
 - If any burner will not light, consult "Trouble Shooting Guide". If problem cannot be resolved, do not attempt to operate the appliance; contact your dealer or approved service centre.

- SHUT DOWN**
- Turn off cylinder valve.
 - Turn control knobs to "OFF".

OPERATION

Burn-off. Before cooking on your gas barbecue for the first time, burn off the barbecue to rid it of any odours or foreign matter as follows:

Remove cooking grids and warming rack and wash in mild soap and water. Ignite the burner. Close the lid and operate the barbecue for **20 minutes** with the control knobs set at “MEDIUM/HIGH”. Turn the gas off at the source. Turn the control knobs to “OFF”. Let the appliance cool down, replace the grids. You are now ready to use the appliance.

Preheating. When grilling, preheat the barbecue on “MEDIUM/HIGH” with the lid closed for ten minutes. Reduce heat as appropriate for what you are grilling. Scrub grids with a wire grill brush and brush or spray the grids with vegetable or olive oil to prevent food from sticking.

Lid Position. The position of the lid during cooking is a matter of personal preference, but the barbecue cooks faster, uses less gas, and controls the temperature best with the lid closed. A closed lid also imparts a smokier flavor to meat cooked directly on the grid, and is essential for smoke and convection cooking.

Vaporization Systems. Your gas grill is designed for use with a vaporization system (included). Do not use lava rock, ceramic briquets or any other vaporization system other than the one that came with the barbecue.

COOKING TEMPERATURES

“HIGH” Setting will produce temperatures at the cooking grid of approximately 600-650°F (320 - 340°C). Use this setting only for fast warm-up and for burning food residue from the cooking grids after the cookout is over. This setting is also ideal for quickly searing steaks before reducing temperature. Rarely, if ever, do you use the “HIGH” setting for extended cooking.

“MEDIUM/HIGH” Setting will produce temperatures at the cooking grid of approximately 550°F (290°C). Use this setting for warm-up and for grilling steaks and chops,

“MEDIUM” Setting will produce temperatures inside the barbecue of approximately 450°F (230°C) with the lid down. Use this setting for most grilling of chicken, burgers, vegetables and for roasting, and baking.

“LOW” Setting will produce temperatures inside the barbecue of approximately 310-350°F (155-175°C). Use this setting for all smoke cooking, large cuts of meat, delicate fish, and for dough and pastry such as pizza and quesadillas.

These temperatures are approximate only and vary with the outside temperature and the amount of wind present.

COOKING TECHNIQUES

DIRECT GRILLING

The direct grilling method involves cooking the food on grids directly over the flame. Direct grilling is the most popular method for most single serving items such as steaks, chops, fish, burgers, kebabs and vegetables.

1. Prepare food in advance to avoid delay and timing problems. If using marinade or spices, they should be applied before placing meat on the cooking grid. If basting with sauces, they should be applied the last 2-4 minutes of grilling to avoid burning.
2. Organize the area around the barbecue to include forks, tongs, oven mitts, sauces and seasonings, to allow you to stay in the vicinity of the barbecue while cooking.
3. Bring meat to room temperature just prior to grilling. Trim excess fat from meat to minimize the “flare-ups” that are caused by dripping grease.
4. Pre-heat the barbecue to the desired temperature with the cover closed.
5. Coat the grids with vegetable or olive oil to prevent food from sticking to the grids.
6. Hold the salt when cooking meats on the barbecue. The meat will stay juicier if the salt is added after cooking.
7. To prevent steaks from “drying out”, use tongs rather than a fork and start on “MEDIUM/HIGH” to sear the meat and seal the juices in. Reduce the heat and extend cooking times when grilling thicker cuts of meat.
8. Learn to test when the meat is done by time and feel. The meat firms up as it cooks. When the meat is soft it is rare. When it is firm, it is well done.
9. Follow the perfect steak grilling guide for most meat, fish, poultry and vegetables.

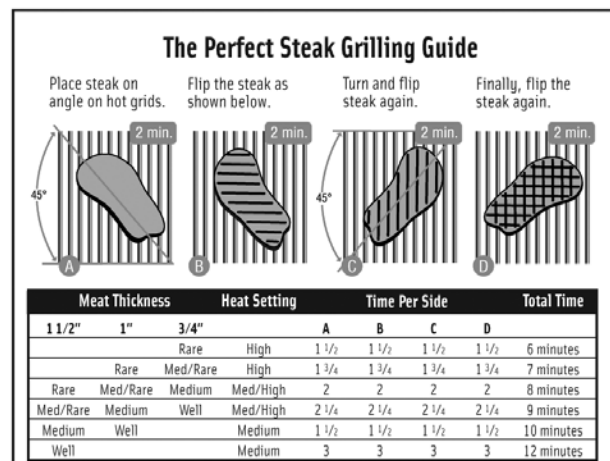

COOKING TECHNIQUES

DIRECT GRILLING GUIDE				
	1" THICK-NESS	HEAT SETTING	TIME PER SIDE	TOTAL TIME
CHICKEN	MED / WELL	MEDIUM	3 / 3 / 3 / 3	12 MIN.
CHICKEN WINGS	MED / WELL	MED / LOW	5 / 5 / 5 / 5	20 MIN.
HAMBURGER	MEDIUM	MEDIUM	3 / 3 / 3 / 3	12 MIN.
HAMBURGERS 3/4" FROZEN	MEDIUM	MEDIUM	3 / 3 / 3 / 3	12 MIN.
FISH FILLET	MEDIUM	MEDIUM	2 / 2 / 2 / 2	8 - 10 MIN.
LOBSTER TAILS SPLIT	MEDIUM	MEDIUM	4 / 4 / 4 / 4	16 - 20 MIN.

INDIRECT CONVECTION COOKING

This method is ideal for cooking large cuts of meat such as roasts or poultry with or without a rotisserie. The food is cooked by hot air circulating around it.

- For most applications of convection cooking with and without a rotisserie, a drip pan is recommended to catch the drippings. Place drip pan on top of the vaporizer, beneath centre of food. Put half to one inch of water in the drip pan. Fruit juice, wine or a marinade may also be added to enhance the flavor. Do not let the drip pan run dry.
- In most cases convection cooking with and without a rotisserie is best with the cover closed and the heat reduced. All burners can be set to "LOW" or the outside burners can be set to medium and the middle burner(s) can be turned "OFF". Turning the centre burner "OFF" will prevent juices in the drip pan from burning.
- Prior to placing the meat on the barbecue, baste the meat with vegetable oil. This will enhance the browning on the outside of the meat.
- When cooking without a drip pan, close attention must be paid to avoid the risk of grease fire and is not recommended.
- Use oven mitts when working around the barbecue to avoid injury.
- Turn barbecue off and allow it to cool before removing drip pan. The fat drippings are highly flammable and must be handled carefully to avoid injury.
- For convection cooking roasts and poultry without a rotisserie, place meat in a roasting rack directly on the grids.

INDIRECT CONVECTION AND ROTISSERIE COOKING GUIDE			
BEEF ROAST	3-6 LB	MED/LOW	2 - 4 HRS
BEEF ROAST	6-10 LB	MED/LOW	3 - 5 HRS
PORK ROAST	2-5 LB	MED/LOW	2 - 4 HRS
PORK ROAST	6-10 LB	MED/LOW	3 - 5 HRS
TURKEY OR CHICKEN	2-5 LB	MED/LOW	2 - 4 HRS
TURKEY OR CHICKEN	5-10 LB	MED/LOW	3 - 5 HRS

When using rotisserie burner, set heat at "MED/HIGH"

ROTISSERIE COOKING

Follow the steps for Indirect Convection Cooking above.

- The rotisserie can accommodate up to 7 kg (15lb) of meat with the limiting factor of rotating clearance. For best results the meat should be centered on the centre line of spit to eliminate an out-of-balance condition.
- The rotisserie can be used with the cooking grids in place if space allows.
- Fasten the meat securely on the spit prior to placing it on the barbecue. For poultry, tie the wings and legs in tightly to avoid contact with drip pan.

INFRARED REAR ROTISSERIE

Certain models feature an infrared rear burner for rotisserie cooking. The infrared rear burner rotisserie method is the ultimate for cooking roasts and poultry. With the heat source located behind the food, there is no chance of a flare up caused by fat drippings. Cook with confidence knowing you will get perfect results every time. A dish or drip pan placed below the spit will collect the juices for basting or for preparing a sauce.

To operate your rear burner, follow the lighting directions on page 6.

MEAT TEMPERATURE GUIDE			
	RARE	MED.	WELL
BEEF / LAMB / VEAL	130°F / 55°C	145°F / 63°C	160°F / 70°C
PORK		150°F / 65°C	170°F / 77°C
POULTRY			170°F / 77°C

For best results use a meat thermometer.

COOKING TECHNIQUES

HOW TO USE A SPIT LEG OF LAMB

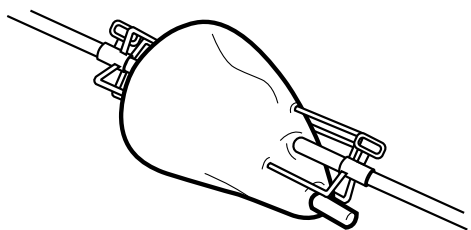

1. Have 3" of bone sawed from small end of leg. Leave meat around bone intact to form a flap. Put a spit fork on rod. Fold flap up and run rod through flap and leg. Put second fork on rod and insert forks in each end of leg. Test for balance. Tighten screws.

POULTRY

1. With breast down; bring neck skin up over cavity. Turn under edges of skin; skewer to back skin. Loop twine around skewer and tie. Turn breast side up; tie or skewer wings to body.

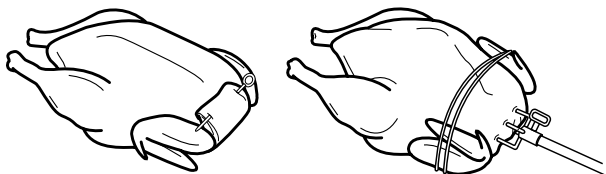

2. Put a spit fork on rod. Insert rod in neck skin parallel to backbone; bring it out just above tail. Put second fork on rod and insert forks in breast and tail. Test for balance. Tighten screws.

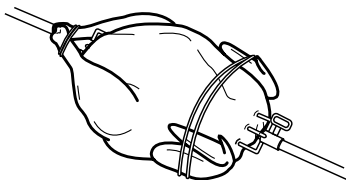

3. Tie tail to rod with twine. Cross legs; tie to tail.

THREE CHICKENS ON A SPIT

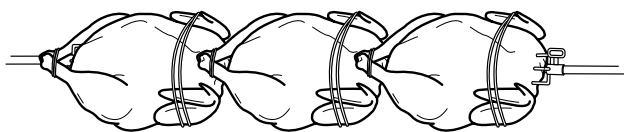

1. Tie or skewer wings to body. Put a spit fork on rod. Dovetail chickens on rod. Loop twine around tails and legs; tie to rod. Put second fork on rod and insert forks in chicken. Tighten screws.

SPIT BALANCE

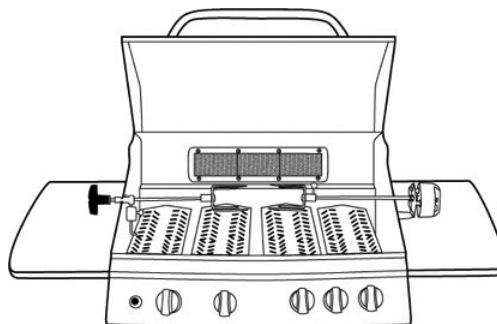

1. Loosen the rod handle to allow the balance to turn freely. Set the rotisserie rod in the slots of the barbecue casting. Let the heaviest side of the meat rotate to the bottom.
2. Adjust the balance to the top of the rod, opposite the heaviest side of the meat. Tighten the rod handle. Periodically, check to see if the meat turns smoothly while cooking. Adjust the balancer as necessary.

CAUTION: Use oven mitt when adjusting balancer.

HOW TO USE A BARBECUE THERMOMETER

1. The accurate way to determine when a large piece of meat is done is to use a barbecue thermometer. Insert the thermometer at an angle so the sturdy pointed metal tip rests in the center of the thickest part of the meat. Be careful that it doesn't touch the spit or the bone, and that the point is not resting in fat.
2. Leave the thermometer in place while the meat revolves. When the thermometer reaches the desired temperature the meat is done. Add your sauces during the last few minutes of cooking time, then take the meat off spit and let the meat stand about 15 minutes to firm up. Carve and serve.

For poultry: insert the tip of the thermometer in the thickest part of the thigh close to the body.

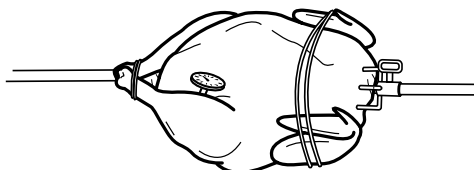

For ham or roasts: insert the tip of the thermometer in the center of the heaviest section of the meat.

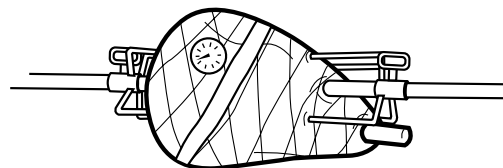

MAINTENANCE

PERIODIC MAINTENANCE

After you have finished, prepare for the next cookout by burning off any residue of food from the grid and vaporizer in the following manner:

Cooking Grids

Remove all food from the grids, turn the control knobs to "HIGH", and operate the barbecue with the lid closed for 5 to 10 minutes or until smoking stops. Turn the gas cylinder valve to "OFF", then the control knobs to "OFF".

Use a long-handled stainless steel wire brush to clean the grids. Remember that the barbecue is hot, so wear kitchen mitts or use a pot-holder to handle the brush.

You do not have to wash the grids and upper cooking rack after each cookout, but if you wish to do so, use a mild soap and water solution, then rinse them thoroughly. Never use a commercial oven cleaner.

Vaporizer

If any residue begins to accumulate on the vaporizer, remove cooking grids and scrape excess residue with back of barbecue brush.

Grease Tray

The grease tray is located on the bottom of the cooking oven immediately below the hole through which grease will drain. The grease tray should be checked and cleaned regularly to prevent grease from overflowing onto your patio.

General Cleaning

When the barbecue is cold, remove the grids. Cover three quarters of the cooking grids with aluminum foil, shiny side down. Ignite the burners; operate the barbecue on "HIGH" with the lid closed for 10 minutes or until smoking stops. Turn the gas cylinder valve to "OFF", turn the control knobs to "OFF". When the barbecue is cool, remove the foil and grids. Scrape the vaporizer clean and remove, then clean the interior of the bottom oven by scraping the sides and vacuuming.

ANNUAL MAINTENANCE

To ensure safe and efficient performance, the following components should be inspected and cleaned at least once per year or after any period of storage exceeding one month.

Burner

Remove burner and inspect for cracks and deterioration.

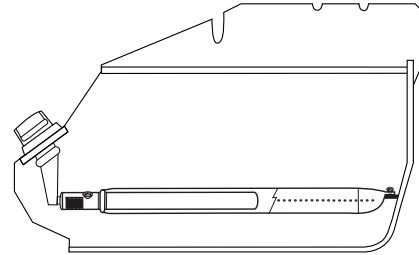

Clean venturi tubes using a pipe cleaner or venturi brush to eliminate any blockages caused by spiders or insects. See "Venturi Tubes".

While burner is removed, clean interior of bottom oven by scraping the sides and vacuuming.

Hose

Inspect and replace if necessary. See "Hose and Regulator".

Side Shelves

Wash with soap and water.

Exterior Finish

Rusting is a natural oxidation process and may appear on cast-iron and steel parts. Rust will not affect short term performance of your grill. Weathering and extreme heat can cause a stainless steel lid to turn a tan color. This is discoloration and is not considered a manufacturing defect.

Replacement Parts

If a problem is found with the regulator, hose, burner, or control valves, do not attempt repair. See your dealer, approved service centre, or contact the factory for repairs or replacement parts. To ensure optimum performance, use only original OMC replacement parts.

Leak Test

After reconnecting gas cylinder, be sure to check for leaks. See "Leak Testing"

TROUBLE SHOOTING

PROBLEM	POSSIBLE CAUSE	CORRECTIVE ACTION
SMELL OF GAS	SHUT OFF GAS CYLINDER VALVE AT ONCE. DO NOT USE THE APPLIANCE UNTIL LEAK IS SEALED.	
Leak detected at cylinder, regulator or other connection.	<ol style="list-style-type: none"> 1. Regulator fitting loose. 2. Gas leak in hose/regulator or control valves. 	<ol style="list-style-type: none"> 1. Tighten fitting and "Leak Test". Pg. 5 2. See authorized service centre.
Flame flashback beneath control panel.	<ol style="list-style-type: none"> 1. Venturi blocked. 	<ol style="list-style-type: none"> 1. Remove burner, clean venturi. See "Venturi Tubes". Pg.5
Burner will not light.	<ol style="list-style-type: none"> 1. Out of LP Gas. 2. Ignitor wire(s) not connected. 3. Ignitor electrode misaligned on burner. 4. Ignitor malfunction. 5. Regulator is not fully connected to the cylinder valve. 6. Burner valve left open while cylinder valve was opened causing excess flow device to activate. 7. A leak in the system causing the excess flow device to activate. 8. Venturi blocked. 9. Venturi not aligned with valve orifice. 10. Orifice blocked. 11. Hose is twisted. 	<ol style="list-style-type: none"> 1. Refill LP Gas Cylinder. 2. Connect both main burner and side burner electrode wires. 3. Realign electrode. 4. Use "Manual Lighting" Procedure. 5. Tighten the regulator hand wheel. 6. Close burner and cylinder valves. Open cylinder valve slowly, then open burner valve to light. 7. Leak test connections to determine loose fitting. Tighten fitting. Leak test system. 8. Remove burner, clean venturi. See "Venturi Tubes". 9. Realign venturi to orifice. See "Venturi Tubes". 10. Remove burner, clean orifice with a pin or fine wire. Do not attempt to drill orifice. 11. Straighten hose. Keep away from bottom casting.
Decreasing heat, "popping sound".	<ol style="list-style-type: none"> 1. Out of LP Gas. 2. Venturi blocked. 	<ol style="list-style-type: none"> 1. Refill LP Gas Cylinder. 2. Remove burner, clean venturi. See "Venturi Tubes".
Hot spots on cooking surface.	<ol style="list-style-type: none"> 1. Venturi blocked. 	<ol style="list-style-type: none"> 1. Remove burner, clean venturi. See "Venturi Tubes".
"Flare-ups" or grease fires.	<ol style="list-style-type: none"> 1. Excessive grease buildup. 2. Excessive heat. 	<ol style="list-style-type: none"> 1. See "Maintenance". 2. Turn burner controls to a lower setting.
Humming noise from regulator.	<ol style="list-style-type: none"> 1. Cylinder valve turned on too quickly. 	<ol style="list-style-type: none"> 1. Turn cylinder valve on slowly.
Yellow Flame.	<ol style="list-style-type: none"> 1. Some yellow flame is normal. If it becomes excessive the venturi may be blocked. 2. Burner ports blocked. 	<ol style="list-style-type: none"> 1. Remove burner, clean venturi. See "Venturi Tubes". 2. Remove burner & clean with soft bristle brush.
Inside of lid appears to be peeling.	<ol style="list-style-type: none"> 1. This is a build up of grease. The inside of the lid is not painted. 	<ol style="list-style-type: none"> 1. Clean with stiff bristle brush or scraper.

WARRANTY

The OMC Warranty is effective from date of purchase and is limited to the repair or replacement of parts at no charge which prove to be defective under normal domestic use. In Canada & the United States replacement is FOB Factory. In all other countries replacement is FOB OMC Distributor. (Consult your Dealer for name of OMC Distributor). All other costs are the responsibility of the owner. This warranty is extended only to the original purchaser as indicated on the warranty registration and applies only to products sold at retail and only when used in country where purchased. (Different types of gas used in different countries require appropriate valves, orifices and regulators.)

WHAT IS COVERED

Stainless Steel Lid & Porcelain Cook Box		5 years
Burners	Main Burner	5 years
All Remaining Parts	Excluding Tank	2 years

WHAT IS NOT COVERED

Any failures or operating difficulties due to accident, abuse, misuse, alteration, misapplication, vandalism, improper installation or improper maintenance or service, or failure to perform normal and routine maintenance, including but not limited to damage caused by insects within the burner tubes, as set out in the owner's manual.

Deterioration or damage due to severe weather conditions such as hail, hurricanes, earthquakes or tornadoes, discoloration due to exposure to chemicals either directly or in the atmosphere.

Shipping or transportation costs. Removal or re-installation costs. Labor costs for installation and repair. Cost of service calls. Liability for indirect, or consequential damages.

REPLACEMENT PARTS

"Genuine OMC Gas Barbecue Parts" must always be used for replacement. Use of any other parts will automatically nullify the above warranty.

WARRANTY CLAIMS

All warranty is handled directly by OMC. Parts must be returned to OMC Warranty Department, shipping charges prepaid, accompanied by Model #, Serial #, and if your grill is not registered, proof of purchase (copy of sales slip or invoice). If inspection confirms the defect, OMC will repair or replace such part in accordance with the terms of the warranty. On receipt of letter or fax (not by phone) OMC may at its option not require part or parts to be returned.

Name		Model #	
Address		Date of purchase	
City, State/Province		Name of dealer	
Postal/Zip Code		Part # (see assembly manual)	
E-mail Address			
Phone #		Fax #	
Problem			

BURNERS

The life of OMC burners (made of stainless steel) depends almost entirely on proper use, cleaning and maintenance. This warranty does not cover failure due to improper use and maintenance.

PORCELAIN COATING

Some OMC cook boxes and cooking grids are coated with a durable porcelain enamel. Porcelain is essentially a glass coating. Some chipping may occur if mishandled. This will not affect the use or performance of the part. These parts are not warranted against chipping or rusting. If some rust appears, remove the rust with a scrub pad and coat with cooking oil.

VAPORIZATION SYSTEMS

OMC Gas Grills are designed for use with a vaporization system. Use of any other product will nullify the warranty.

LP GAS CYLINDER

OMC does not manufacture LP Gas Cylinders. The LP Gas Cylinder manufacturer is responsible for the materials, workmanship and performance of the cylinder. If the cylinder has a defect, malfunctions, or you have a question regarding the cylinder, contact your dealer or the cylinder manufacturer.