

This Owner's Manual is provided and hosted by [Appliance Factory Parts](http://www.appliancefactoryparts.com).



# Broil-Mate 1559-54 Owner's Manual

[Shop genuine replacement parts for Broil-Mate 1559-54](#)



[Find Your Broil-Mate Grill Parts - Select From 682 Models](#)

----- Manual continues below -----



E-Z BILT BARBECUES

ASSEMBLY MANUAL & PARTS LIST

MANUEL DE MONTAGE & LISTE DE PIÈCES

broil-mate™

1551-54  
1559-54



STERLING.6

4451-54



broil-mate™

1551-64



STERLING.6

4451-64



broil-mate™

1551-74

STERLING.6

4551-74



STERLING.6

4451-74



broil-mate™

1651-54



RETAIN FOR FUTURE REFERENCE

VEUILLEZ CONSERVER POUR REFERENCE ULTERIEURE

1-800-265-2150

info@omcbbq.com

*Onward*  
MANUFACTURING COMPANY LIMITED  
SINCE 1906  
585 KUMPF DRIVE  
WATERLOO, ONTARIO, CANADA  
N2V 1K3

S18430 REV B 11/07

1

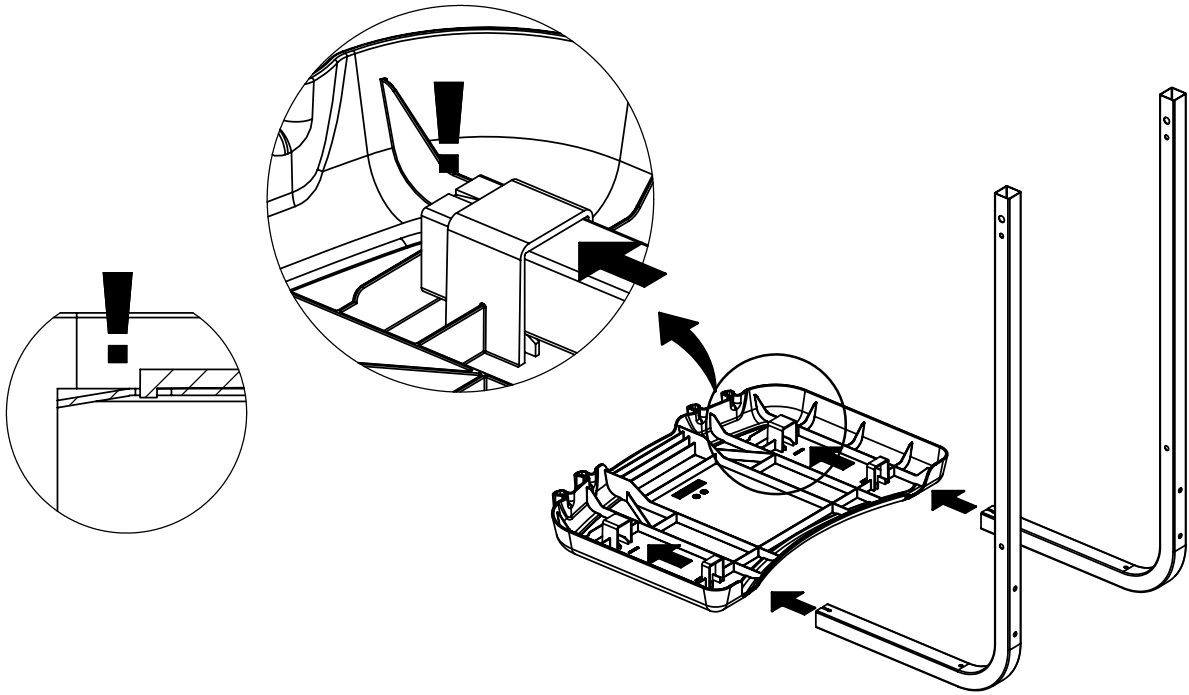

2

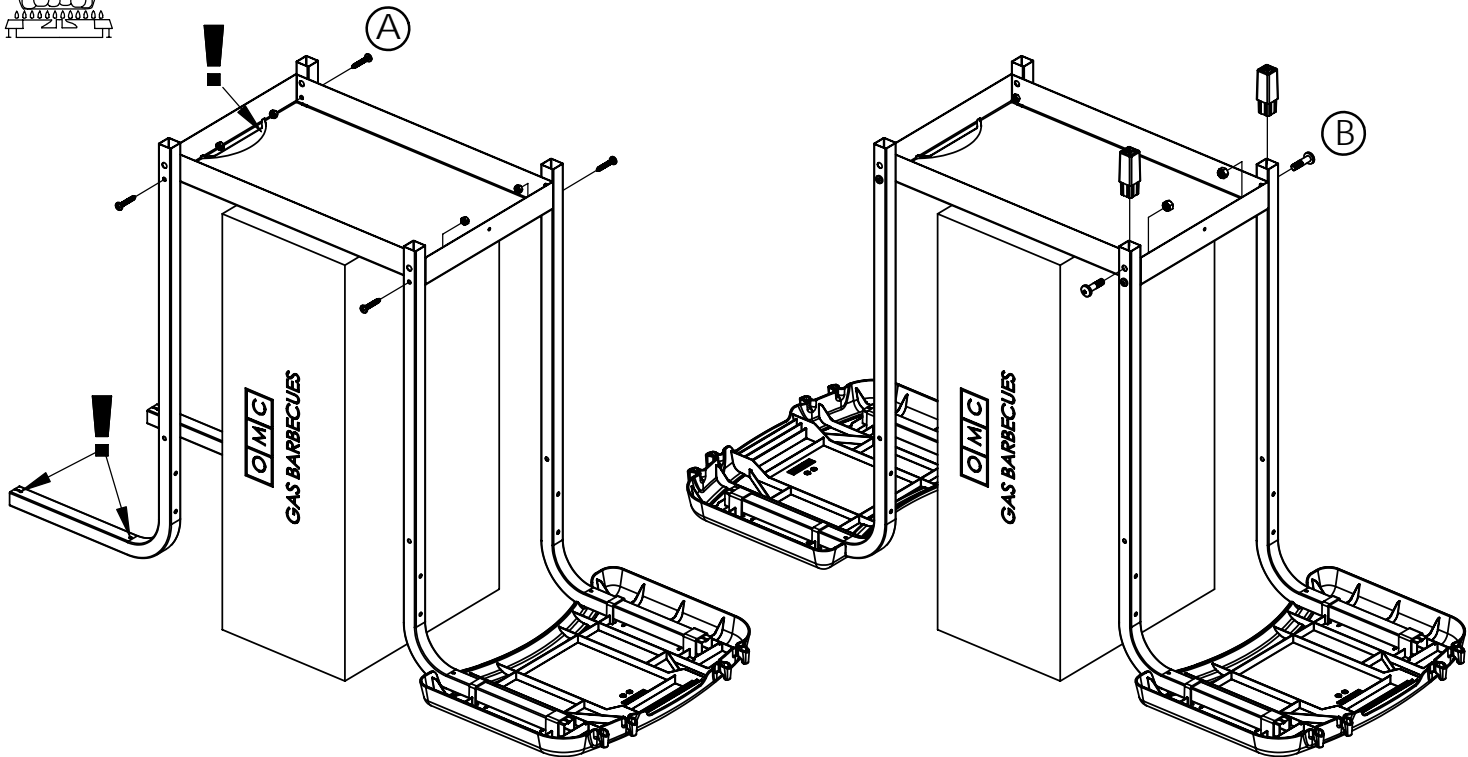
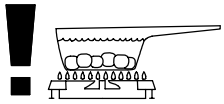
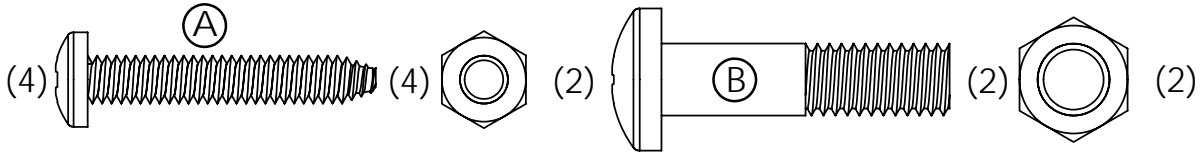

**3**

(2)

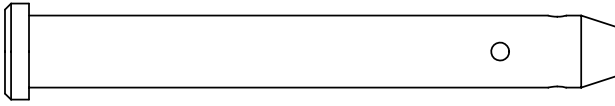

(2)

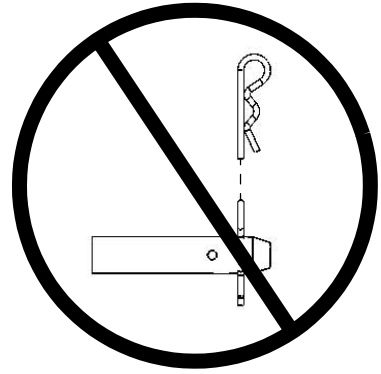
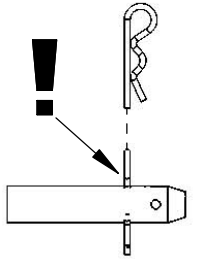
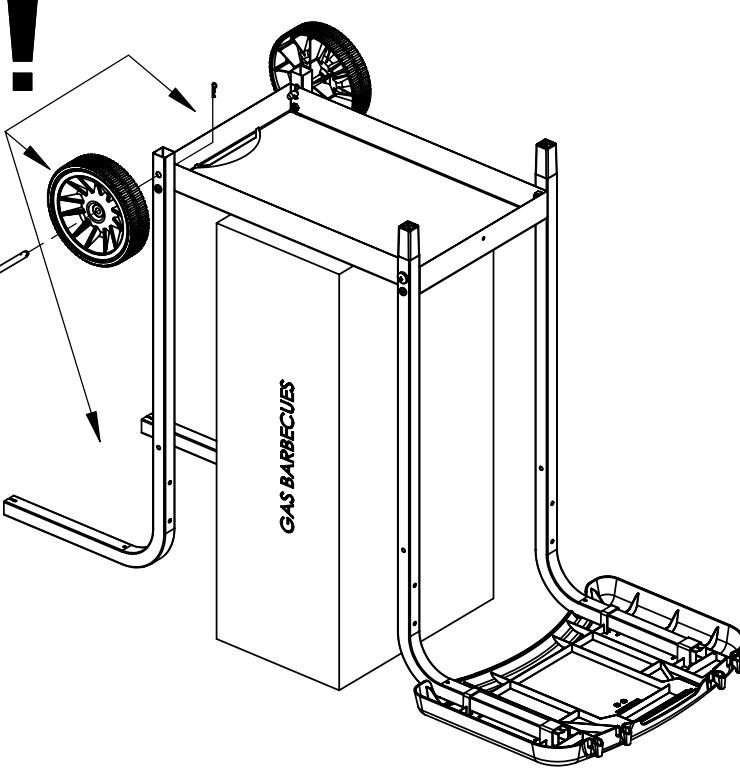
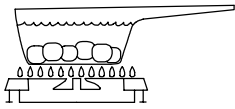
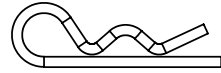

**4**

(4)

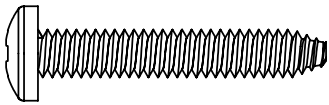

(4)

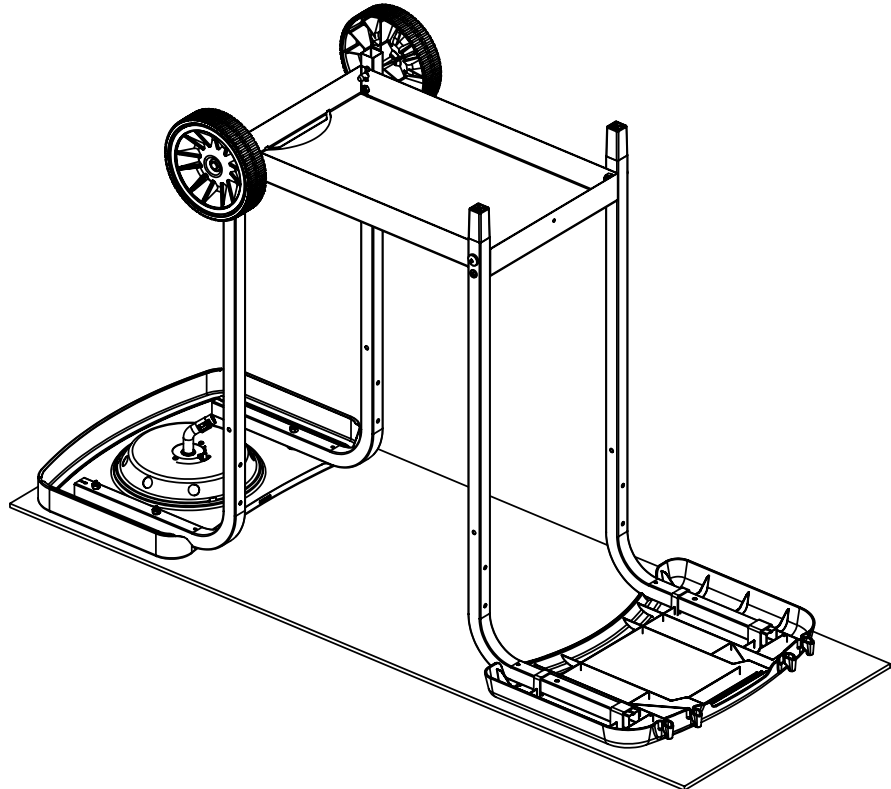
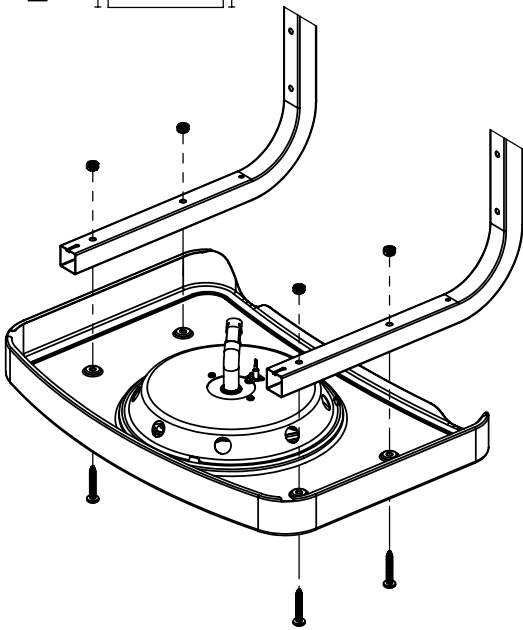
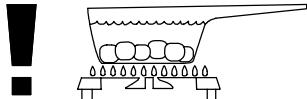
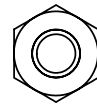

**5**

(8)

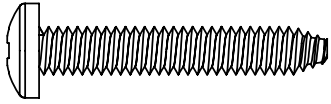

(8)

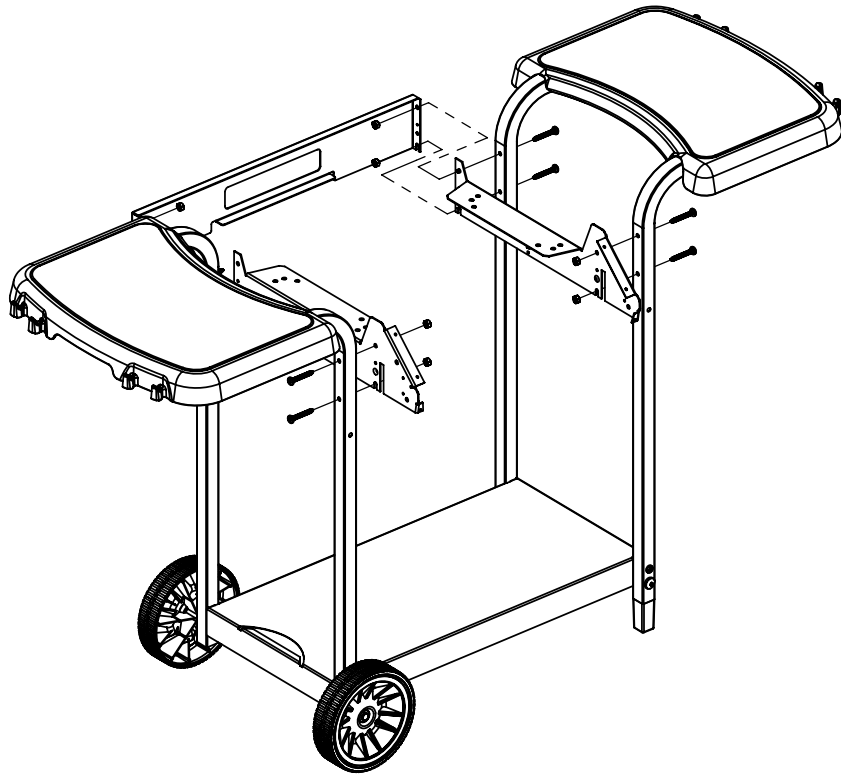
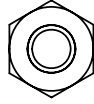

**6**

(6)

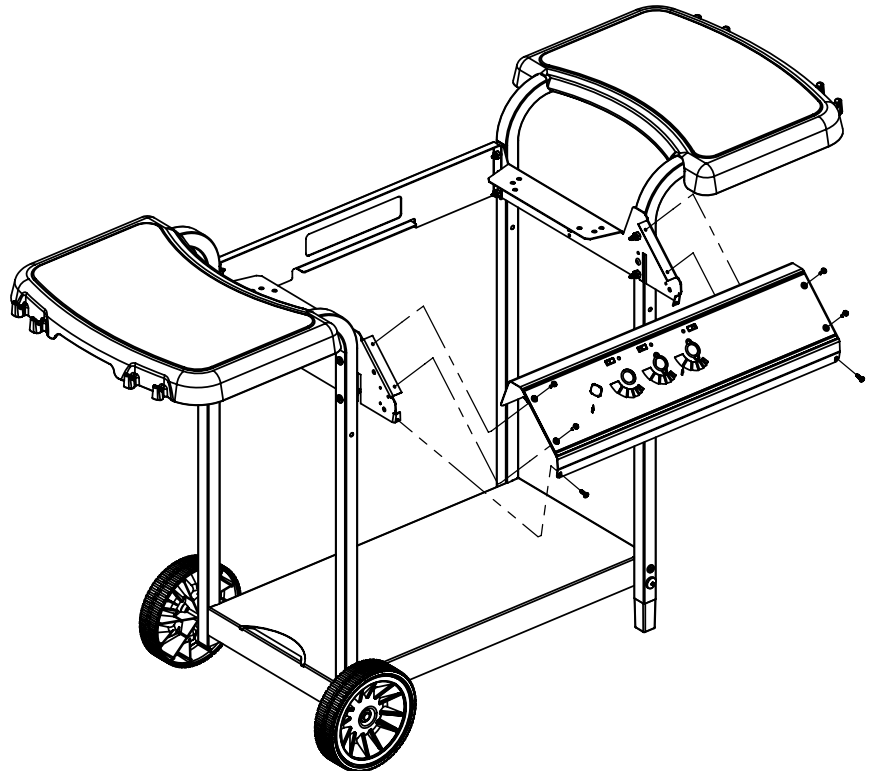
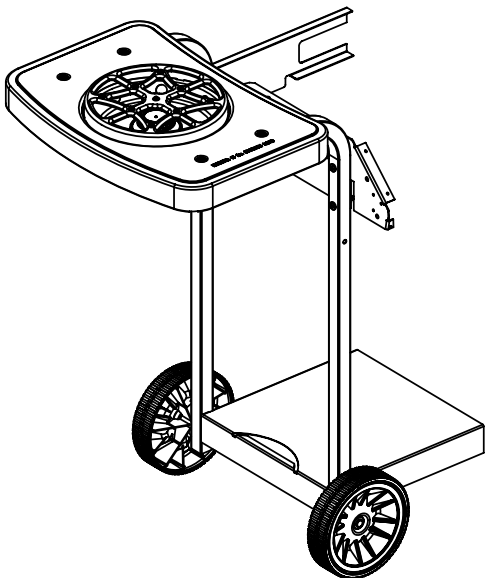
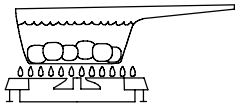
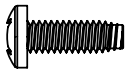

7

(2/4)

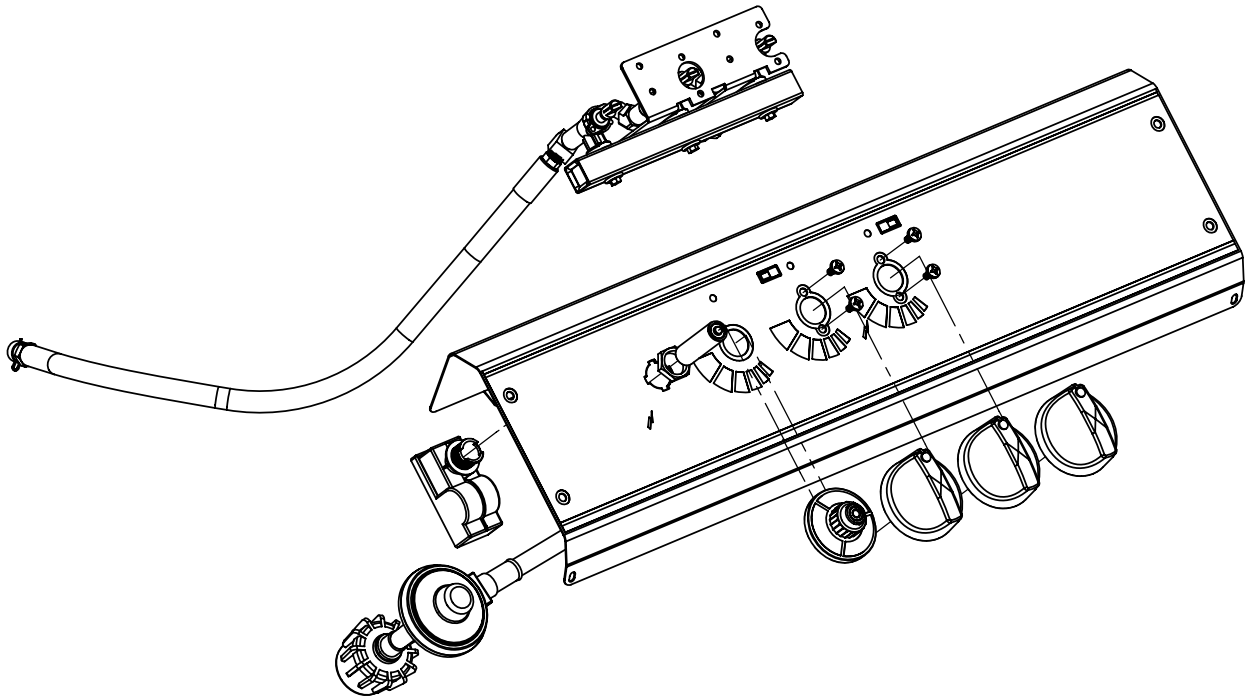
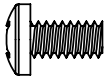

8

(4)

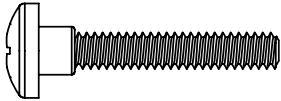

(4)

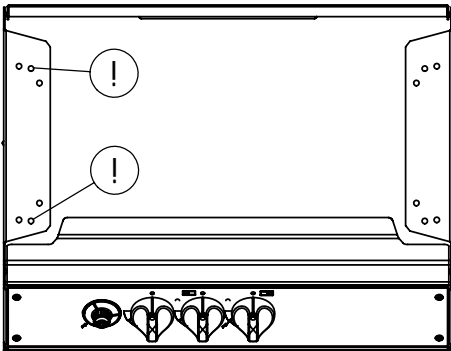
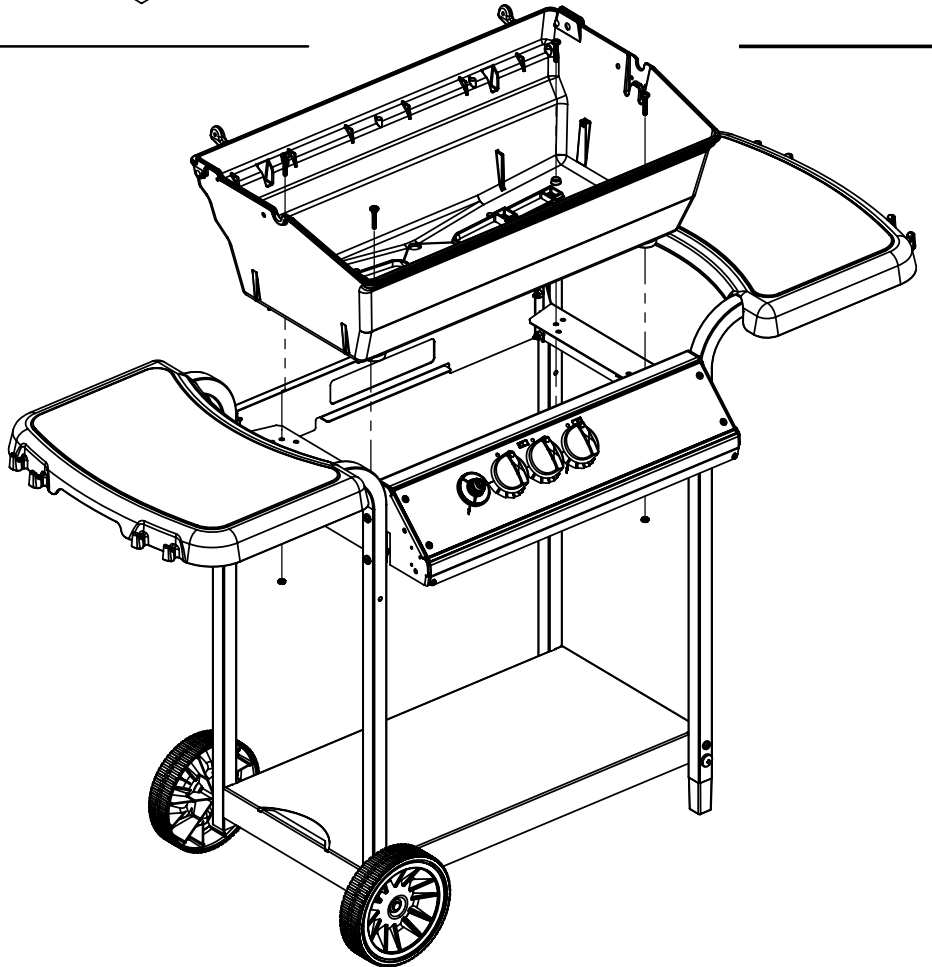

9

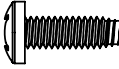
(2) 

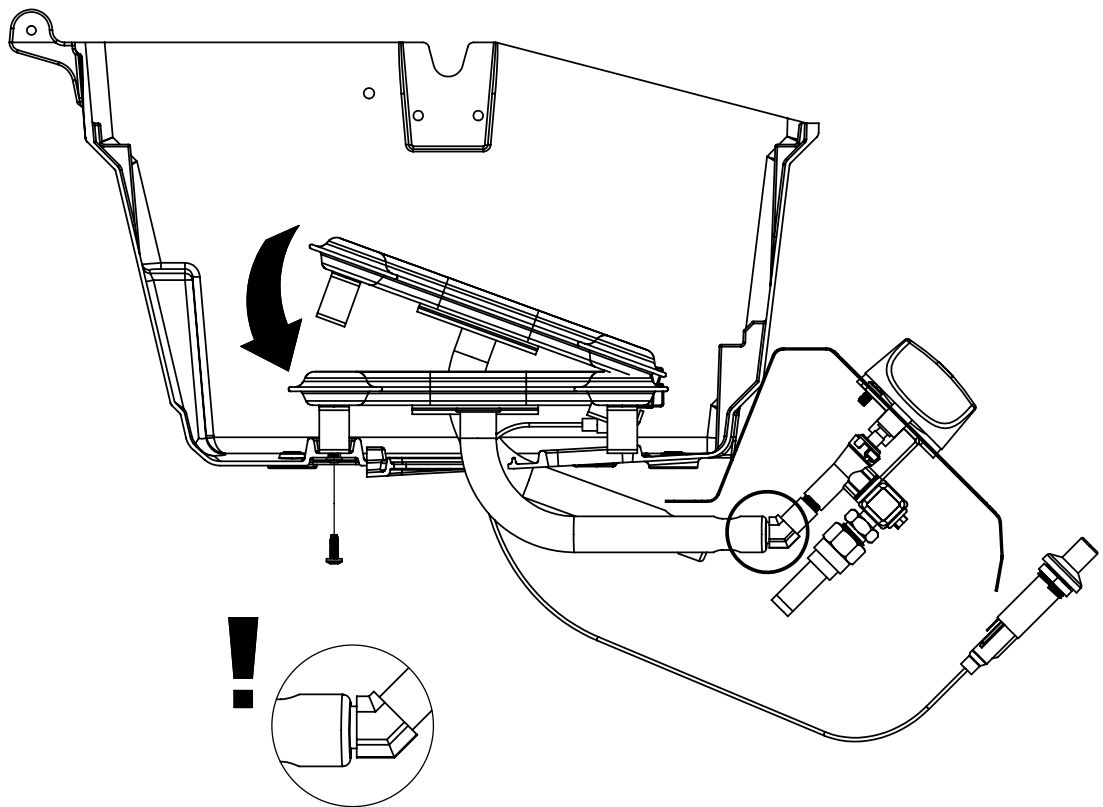
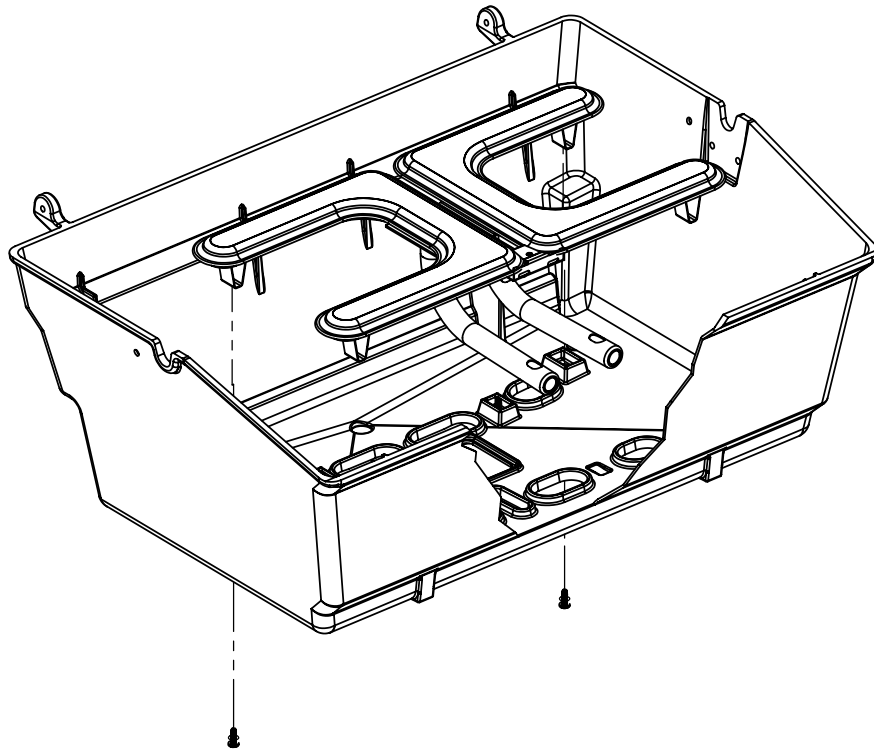

**10**

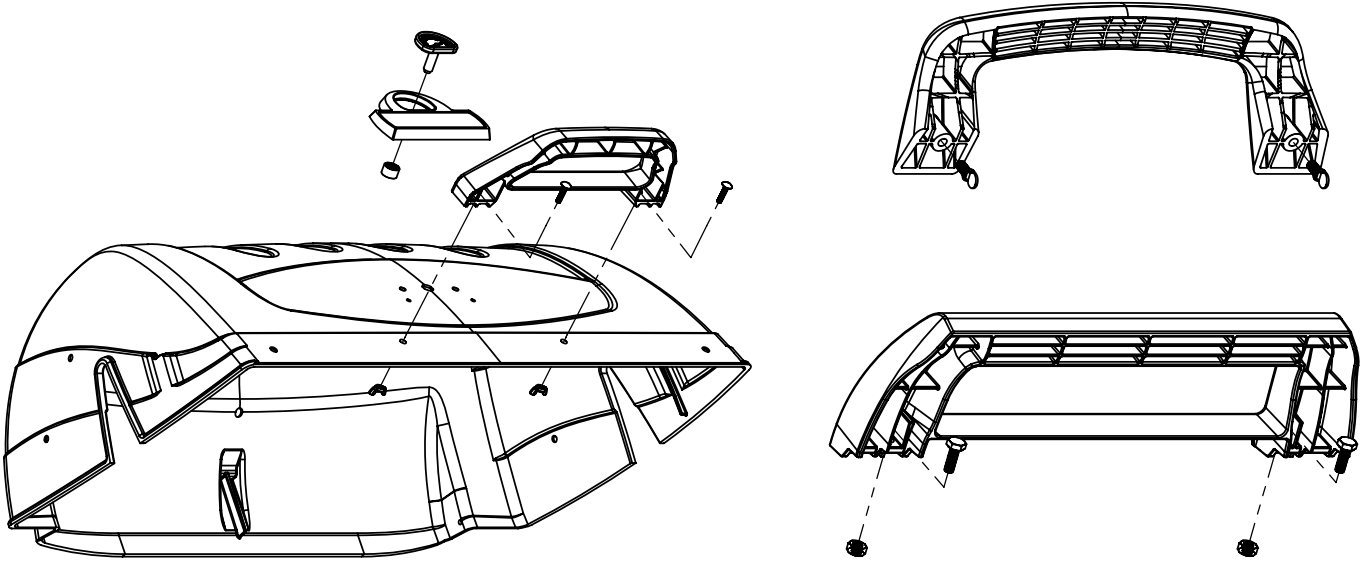
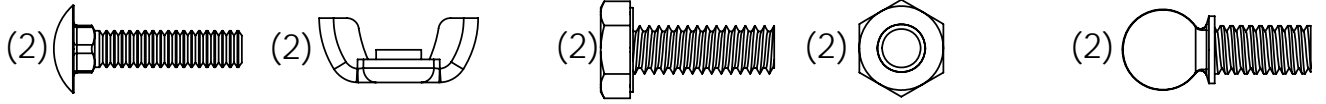

**11**

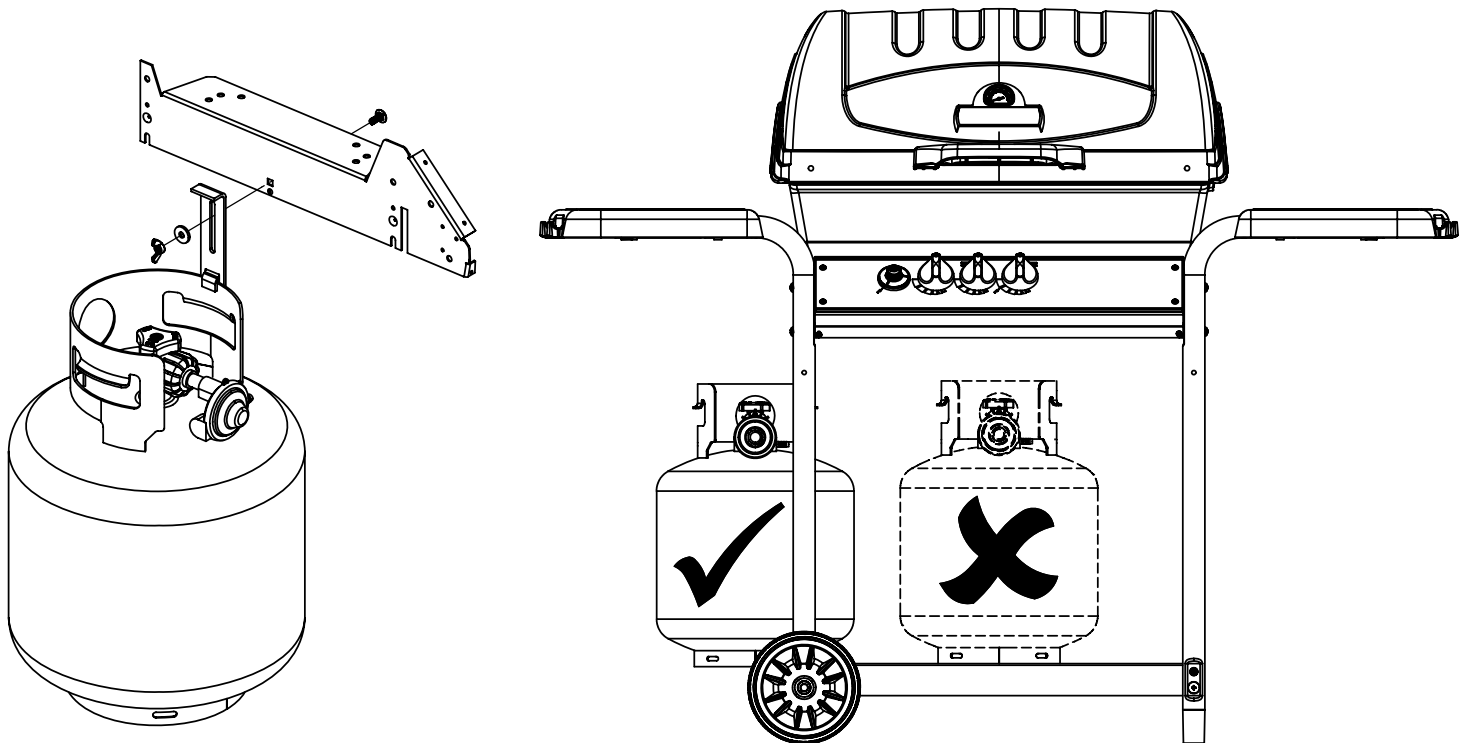
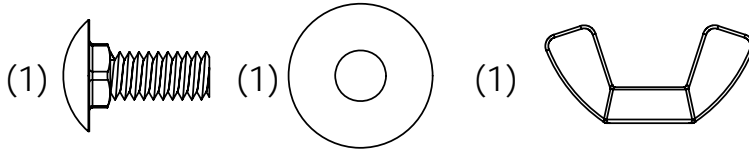

12

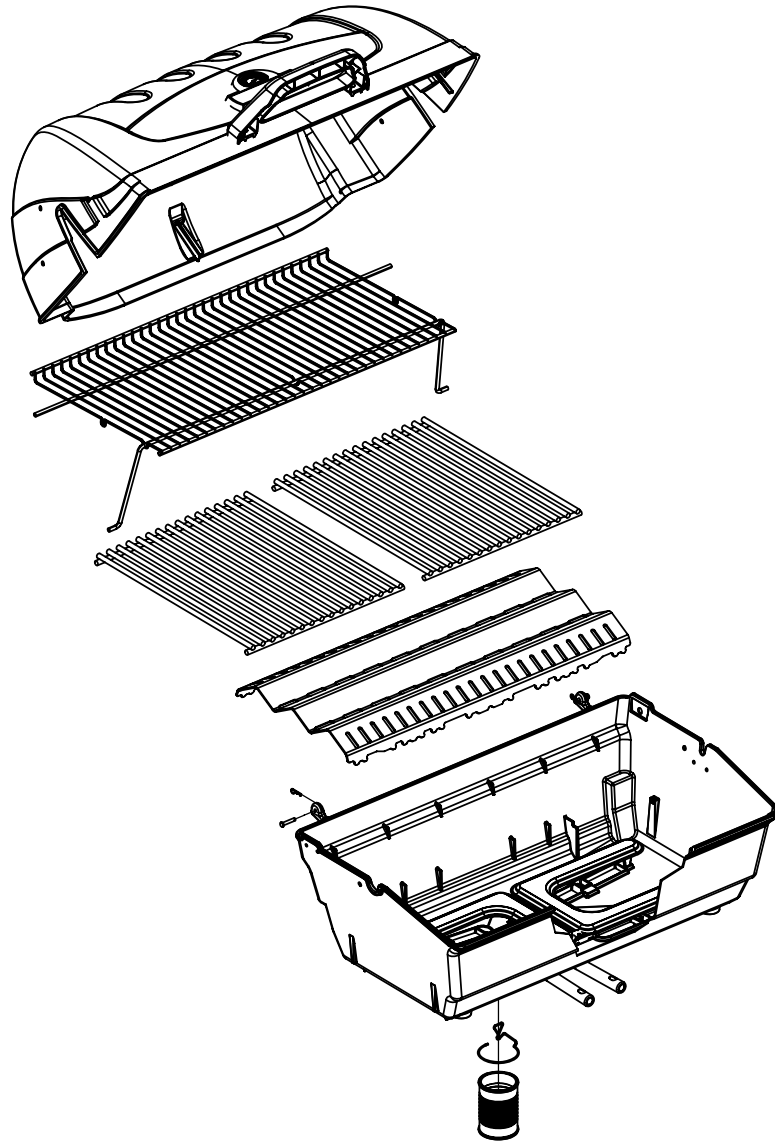
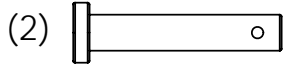

13

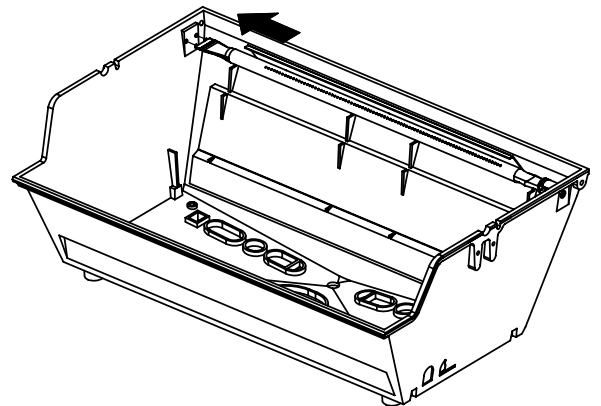
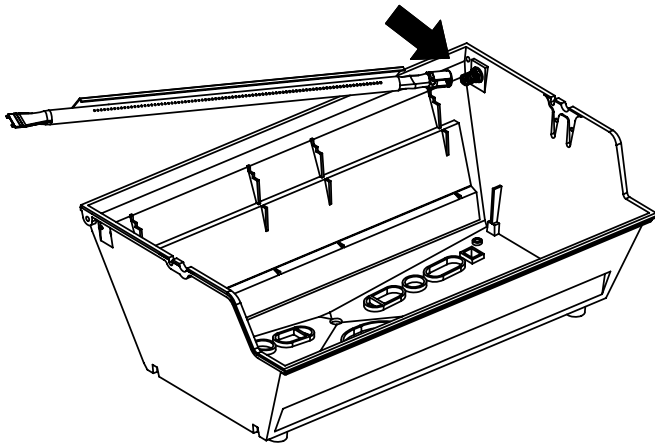

14

(1)

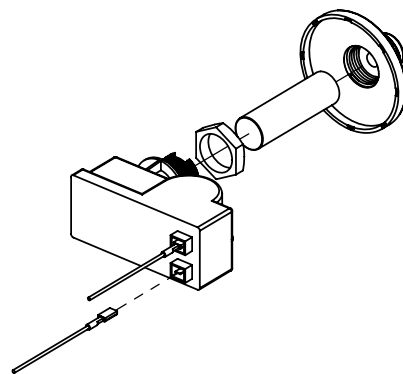
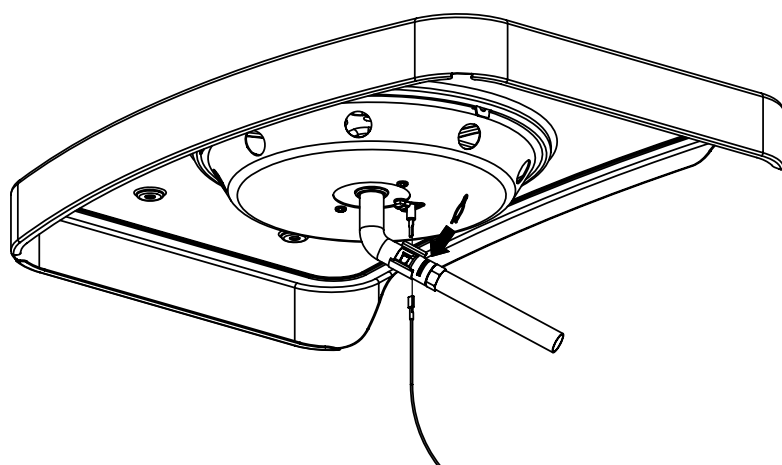
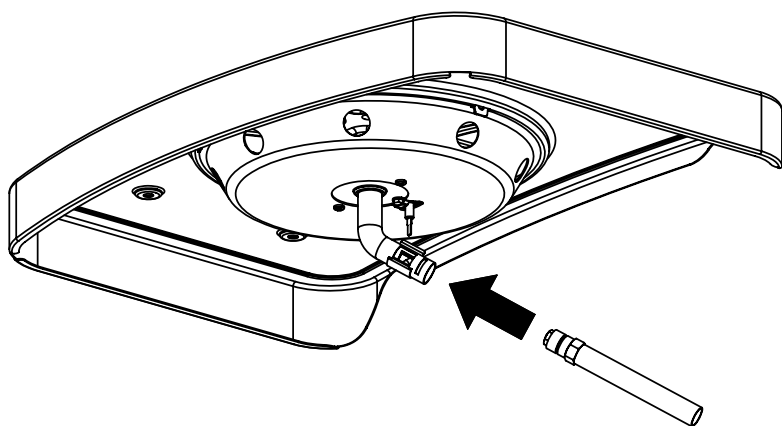
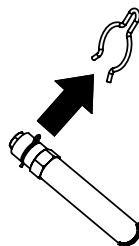
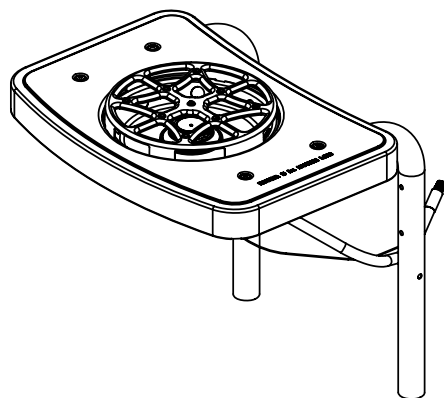
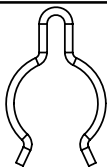

15

(2)

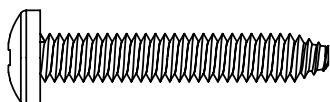

(2)

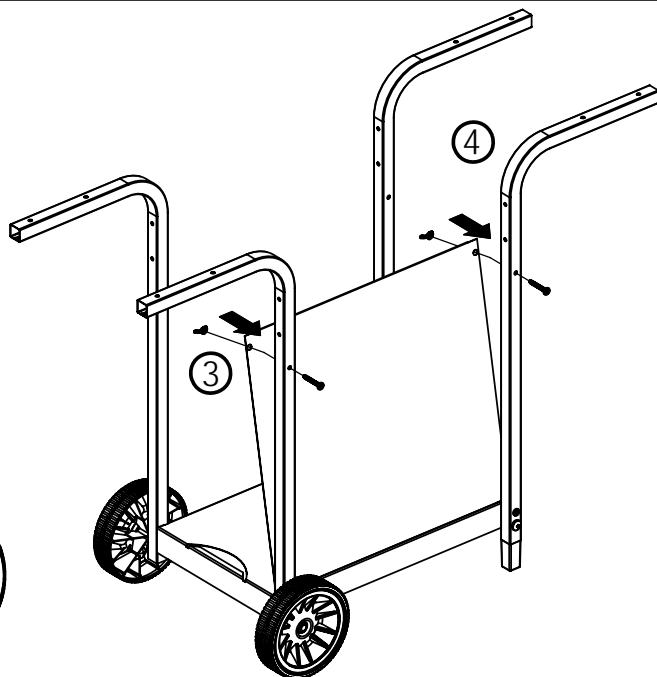
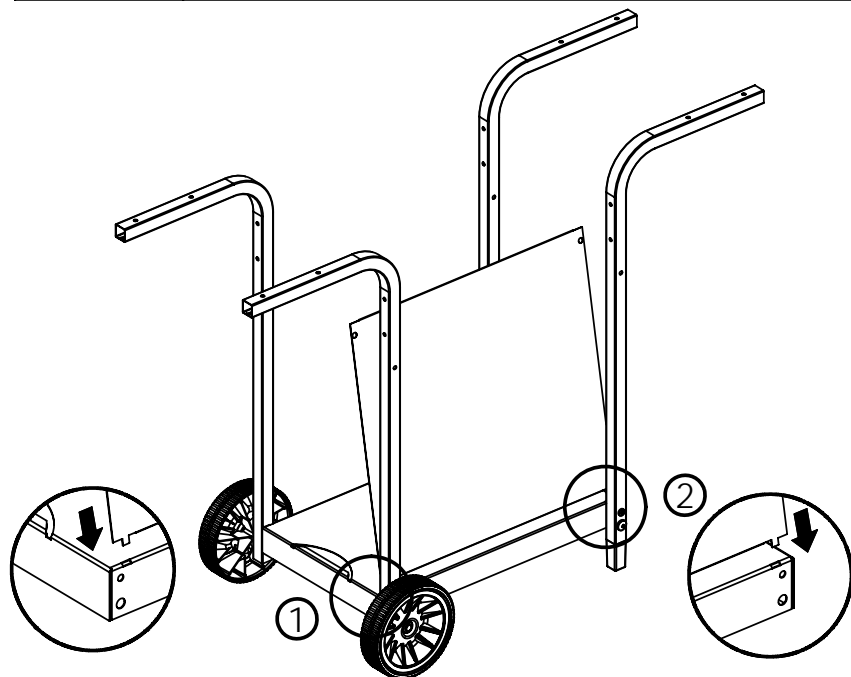
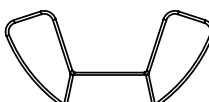

**PARTS LIST / LISTE DES PIECES**

#	#	DESCRIPTION	DESCRIPTION	1551-54	1551-64	1551-74	1559-54	1651-54	4451-54	4451-64	4451-74
1	34120194	CASTING BOTTOM	FOND DU FOYER	1	1	1	1	1	1	1	1
2	34110320	CASTING TOP	COUVERCLE DU GRIL	•	•	•	•	1	•	•	•
	34110327	CASTING TOP	COUVERCLE DU GRIL	•	•	•	•	•	1	1	1
	34110330	CASTING TOP	COUVERCLE DU GRIL	1	1	1	1	•	•	•	•
3	10081-BM50	NAMEPLATE	PLAQUE D'IDENTIFICATION	1	1	1	1	1	•	•	•
	10081-S50	NAMEPLATE	PLAQUE D'IDENTIFICATION	•	•	•	•	•	1	1	1
4	S21061	WING NUT - 10-24	ECROU - 10-24	•	•	•	•	•	2	2	2
5	10571-5	HEAT INDICATOR	INDICATEUR DE CHALEUR	1	1	1	1	1	1	1	1
6	32300112	HINGE PIN	ATTACHE DE CHEVILLE	2	2	2	2	2	2	2	2
7	S21233	HINGE CLIP	ATTACHE DE CHEVILLE	4	4	4	4	4	4	4	4
8	10222-T425	FLAV-R-WAVE	FLAV-R-WAVE	1	1	1	1	1	1	1	1
9	38170121	GRID	GRILLE	2	2	2	2	2	2	2	2
11	38110158	GRID – WARMING RACK	GRILLE	•	•	•	•	•	1	1	1
	38110164	GRID – WARMING RACK	GRILLE	1	1	1	1	1	•	•	•
15	S10017	BURNER ASSY	ENSEMBLE DE BRULEUR	1	1	1	1	1	1	1	1
17	10342-244	IGNITOR	ALLUMEUR	1	•	1	1	1	1	•	1
	10342-245	IGNITOR	ALLUMEUR	•	1	•	•	•	•	1	•
18	S15500	ELECTRODE	ELECTRODE	1	1	1	1	1	1	1	1
21	10440-T50	CONTROL ASSY LP	SOUPAPE, (GAZ PROPANE)	1	•	•	1	1	1	•	•
	10442-T52	CONTROL ASSY LP	SOUPAPE, (GAZ PROPANE)	•	1	•	•	•	•	1	•
	10440-T64	CONTROL ASSY LP	SOUPAPE, (GAZ PROPANE)	•	•	1	•	•	•	•	1
21A	S13467-091	HOSE - SIDE BURNER LP	TUYAU DU BRULEUR LATERAL PL	•	1	•	•	•	•	1	•
	Y-11230	COTTER PIN	ATTACHE DE CHEVILLE	•	1	•	•	•	•	1	•
21B	10110-39	TUBE-REAR BURNER ASSY	TUBE DE BRULEUR ARRIERE	•	•	1	•	•	•	•	1
22	10114-20	HOSE & REGULATOR LP	TUYAU ET REGULATEUR PL	1	1	1	1	1	1	1	1
23	10472-K37	CONTROL KNOB	BOUTON DE CONTROLE	2	3	3	2	2	2	3	3
31	10194-E53S	CONTROL COVER	PANNEAU DE CONTROLE	1	•	•	1	1	1	•	•
	10194-E55S	CONTROL COVER	PANNEAU DE CONTROLE	•	1	•	•	•	•	1	•
	10194-E57S	CONTROL COVER	PANNEAU DE CONTROLE	•	•	1	•	•	•	•	1
32	10338-E321	BENT LEG	JAMBE COUDÉE	4	4	4	4	4	4	4	4
35	10184-E401	SUPPORT CASTING - LEFT	SUPPORT GAUCHE DU FOYER	1	1	1	1	1	1	1	1
36	10184-E411	SUPPORT CASTING - RIGHT	SUPPORT DROIT DU FOYER	1	1	1	1	1	1	1	1
39	10956-E561	BRACE - UPPER REAR	SUPPORT ARRIERE	1	1	1	1	1	1	1	1
40	S17347	SHELF - LOWER	TABLETTE INFERIEURE	1	1	1	1	1	1	1	1
46	S17106	BRACKET – CYLINDER LP	SUPPORT DU RESERVOIR PL	1	1	1	1	1	1	1	1
50	30260130	SHELF – SIDE	PLANCHETTE LATERALE	2	1	2	2	2	2	1	2
54	10956-E702	FRONT PANEL	PANNEAU AVANT	1	1	1	1	1	1	1	1
56	10892-7	WHEEL	ROUE	2	2	2	2	2	2	2	2
66	S13005	BURNER ROTISSERIE	BRULEUR A ROTISS	•	•	1	•	•	•	•	1
68	S21362	SPRING	RESSORT	•	•	1	•	•	•	•	1
70	Y-11990	HEX NUT	ECROU	•	•	1	•	•	•	•	1
71	10696-109	REARBURNER-ORIFICE PL	ORIFICE DU BRULEUR ARRIERE PL	•	•	1	•	•	•	•	1
74	32500179	BOLT - 10:24 X 3/4	BOULON - 10:24 X 3/4	•	•	•	•	•	2	2	2
	32010221	THUMB SCREW	VIS	2	2	2	2	•	•	•	•
	S21014	BOLT - 1/4-20 X 3/4	BOULON - 1/4-20 X 3/4	•	•	•	•	2	•	•	•
75	30230228	LID HANDLE	POIGNEE	•	•	•	•	•	1	1	1
	30230229	LID HANDLE	POIGNEE	1	1	1	1	•	•	•	•
	30230230	LID HANDLE	POIGNEE	•	•	•	•	1	•	•	•
77	S15111	GREASE CUP HOLDER	PORTE CONTENANT A GRAISSE	1	1	1	1	1	1	1	1
78	S21350	LEG PLUG - EXTENSION	EMBOUT DE JAMBE	2	2	2	2	2	2	2	2
81	Y-11560	BOLT 1/4 : 20 x 1 3/4	BOULON 1/4 : 20 x 1 3/4	14	18	14	14	14	14	18	14
82	Y-29300	BOLT 10 -24 x 1 1/4	BOULON 10 -24 x 1 1/4	4	4	4	4	4	4	4	4
83	S21141	CARRIAGE BOLT - 1/4:20 X 5/8	BOULON - 1/4:20 X 5/8	1	1	1	1	1	1	1	1
84	Y-29307	NUT 10 -24	ECROU 10 -24	4	4	4	4	4	4	4	4
85	S21255	WASHER	RONDELLE	1	1	1	1	1	1	1	1
87	Y-11793	NUT - 1/4	ECROU - 1/4	12	16	12	12	14	12	16	12
88	Y-11598	NUT WING - 1/4	ECROU PAPILLON - 1/4	3	3	3	3	3	3	3	3
91	Y-11968	HEX HEAD BOLT 3/8 : 16 x 1 3/4	BOULON	2	2	2	2	2	2	2	2
94	Y-12285	NUT – 3/8	ECROU – 3/8	2	2	2	2	2	2	2	2
96	Y-29304	BOLT - 10:24 X 3/8	BOULON - 10:24 X 3/8	2	4	4	2	2	2	4	4
97	10240-13	WHEEL BOLT	ROUE BOULON	2	2	2	2	2	2	2	2
98	S21124	SCREW - 8 X 1/2	VIS - 8 X 1/2	8	8	8	8	8	8	8	8
106	Y-12835	SCREW 6:32 X 1/4	VIS 6:32 X 1/4	•	2	•	•	•	•	2	•
109	S21136	SCREW – 8-32 x 3/8	VIS – 8-32 x 3/8	1	1	1	1	1	1	1	1
110	33110154	TRIVET	GRIL POUR BRULEUR LATERALE	•	1	•	•	•	•	1	•
111	10390-E10	SIDE BURNER	BRULEUR DE COTE	•	1	•	•	•	•	1	•
113	10342-T12	ELECTRODE - SIDE BURNER	ELECTRODE – BRULEUR DE COTE	•	1	•	•	•	•	1	•
117	33110159	SHELF - SIDE BURNER	SUPPORT DE BRULEUR DE COTE	•	1	•	•	•	•	1	•

