

# Broil King®

REDDI-BILT BARBECUES

ASSEMBLY MANUAL & PARTS LIST

MANUEL DE MONTAGE & LISTE DE PIÈCES

**Broil King®**

9956-54  
9956-57



**Broil King®**

9956-54B  
9956-57B

9959-54  
9959-57



RETAIN FOR FUTURE REFERENCE

VEUILLEZ CONSERVER POUR REFERENCE ULTERIEURE

1-800-265-2150

[info@omcbbq.com](mailto:info@omcbbq.com)

*Onward*  
SINCE 1906  
MANUFACTURING COMPANY  
585 KUMPF DRIVE LIMITED  
WATERLOO, ONTARIO, CANADA  
N2Y 1K3

10084-K54 Rev B 11/07



1

(2)

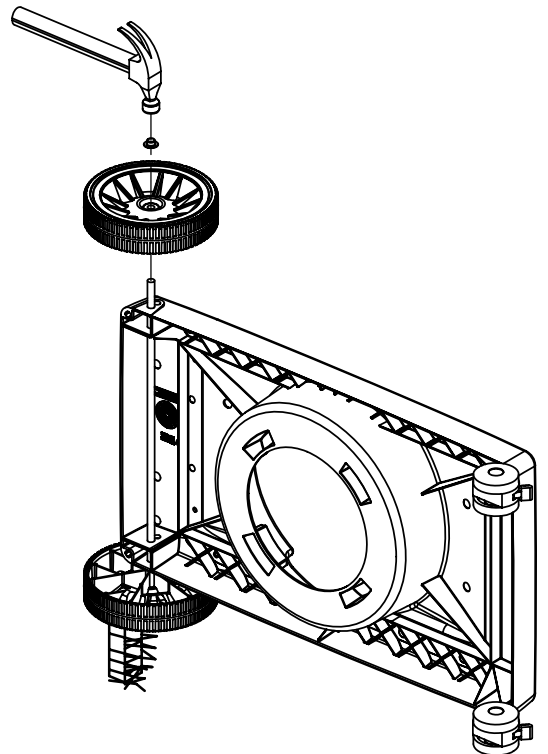
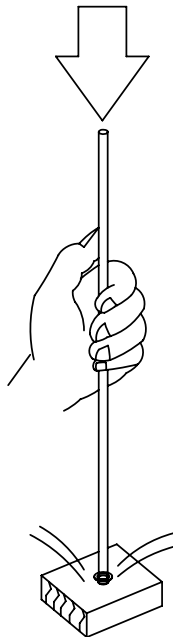
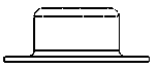
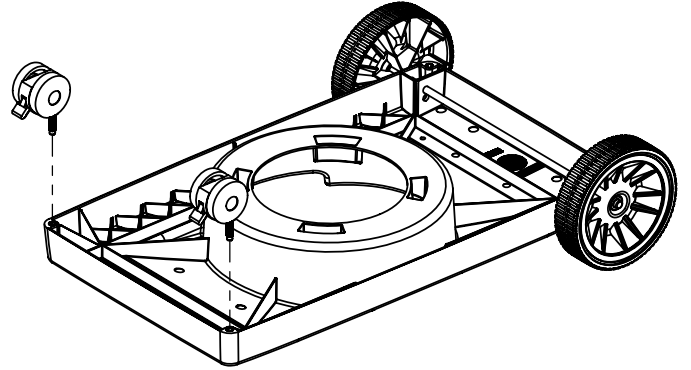
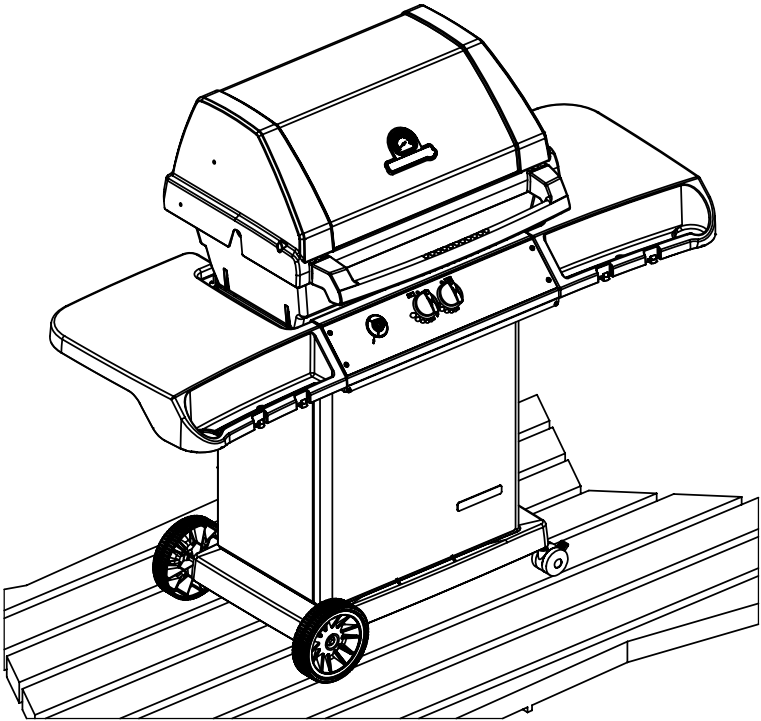
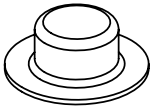

**2**

(2) 

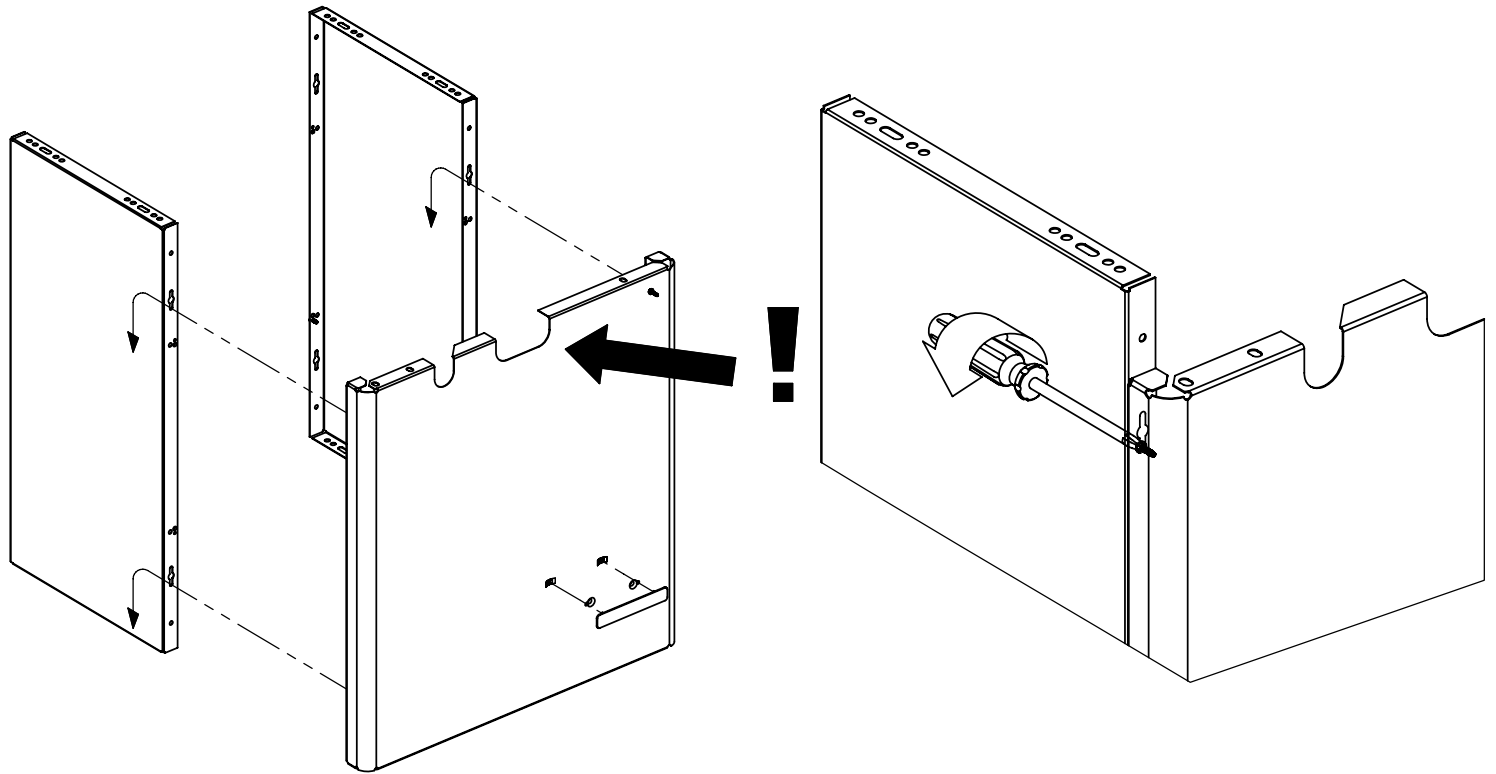

**3**

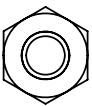
(4) 

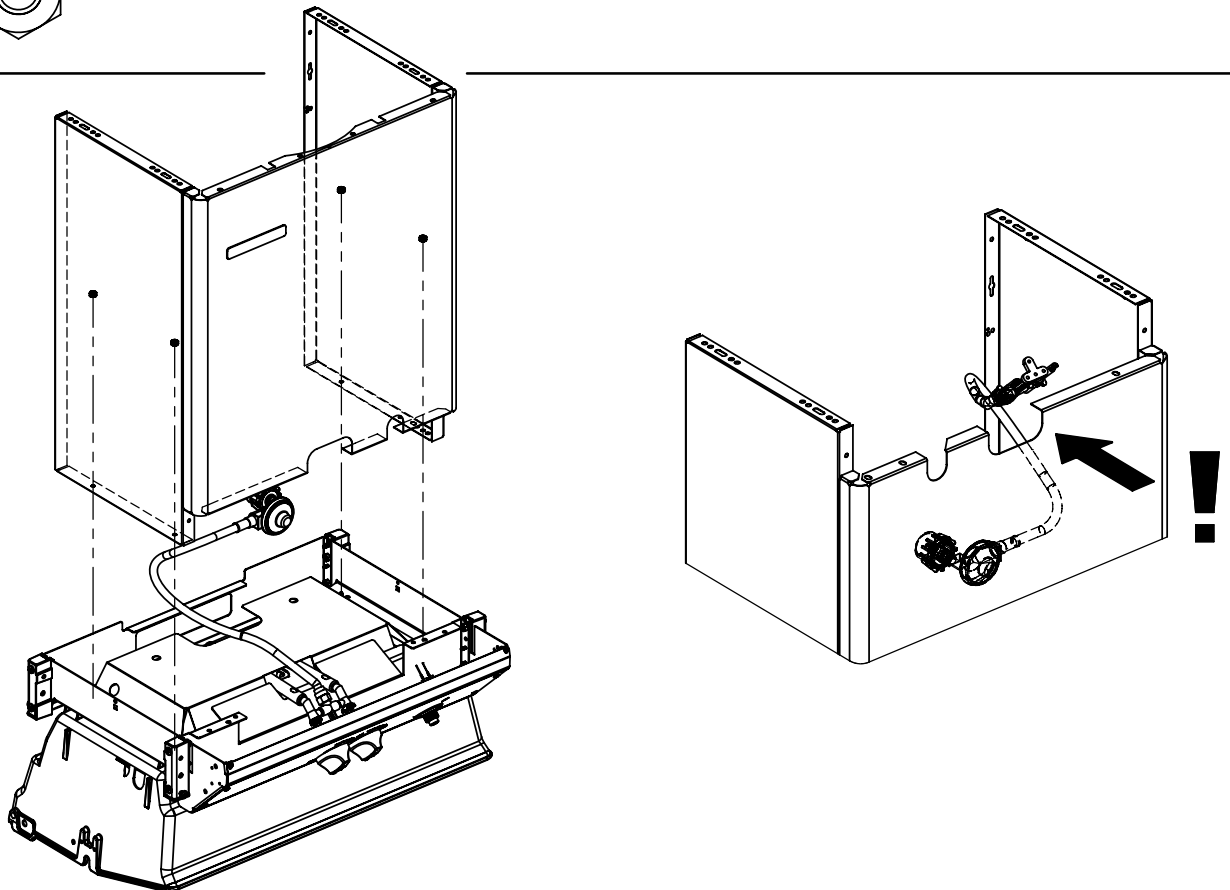

4

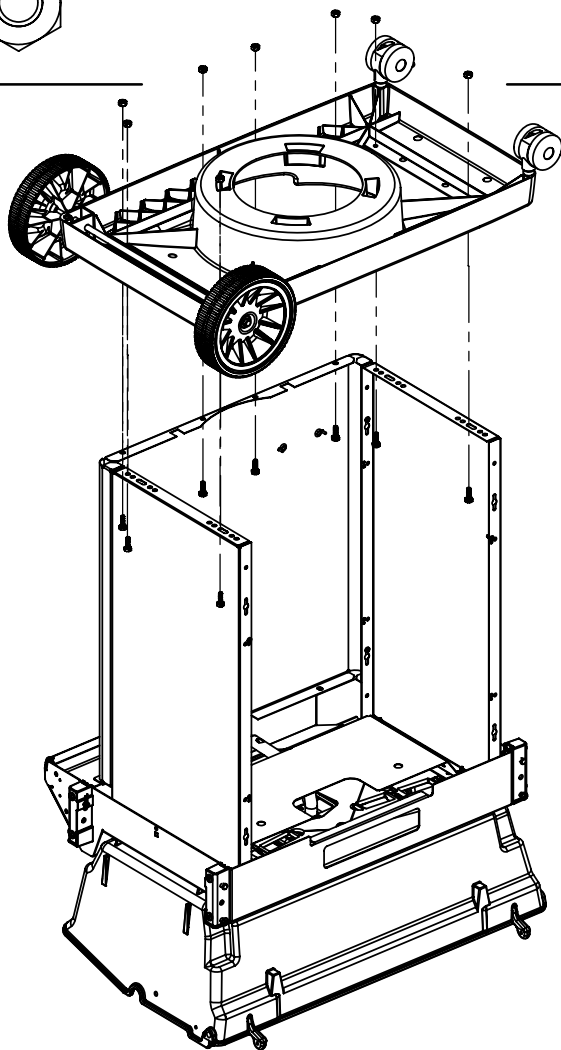
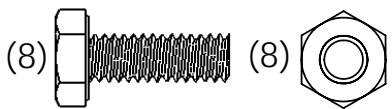

5

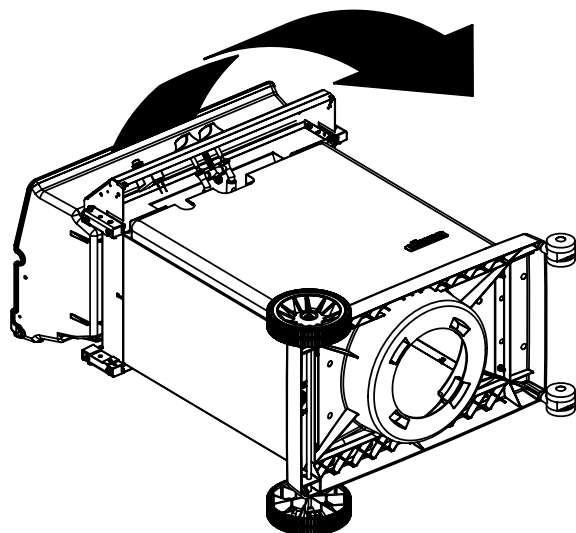
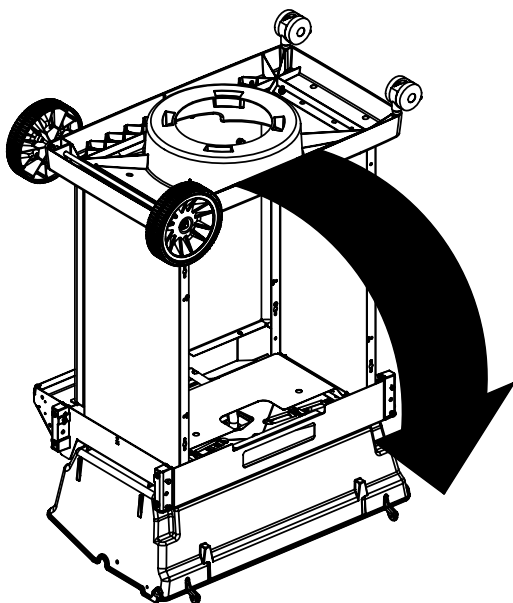

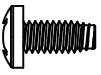

6

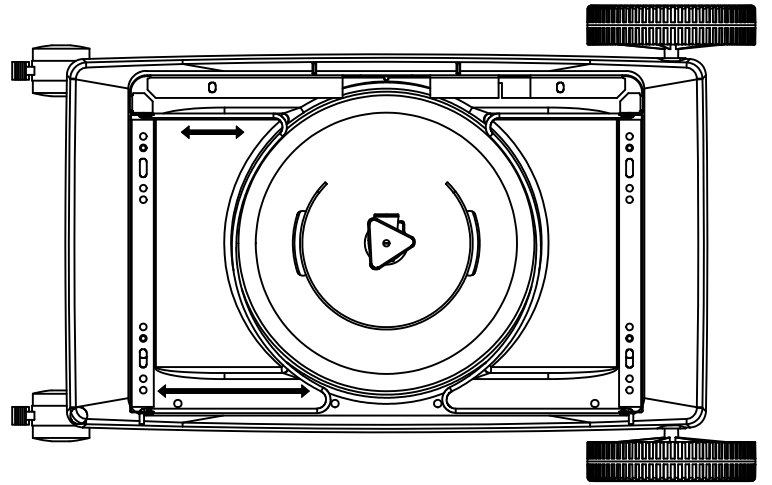
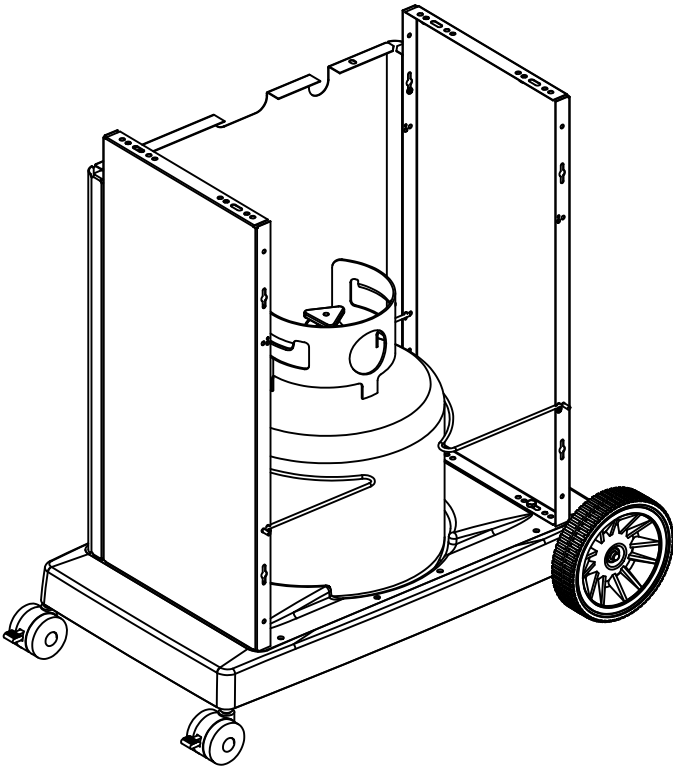
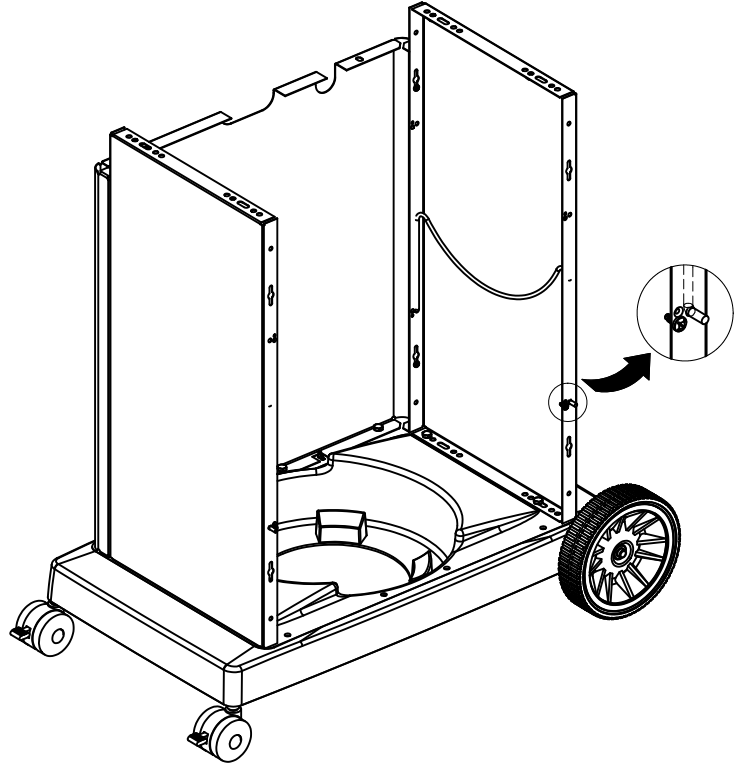
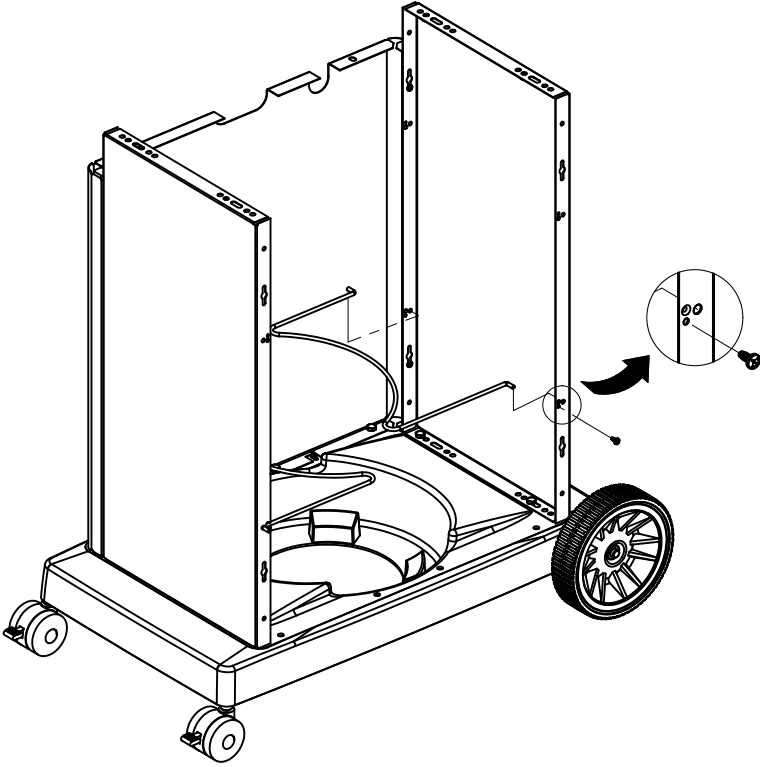
(2) 

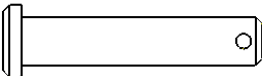

7

(4)  (4) 

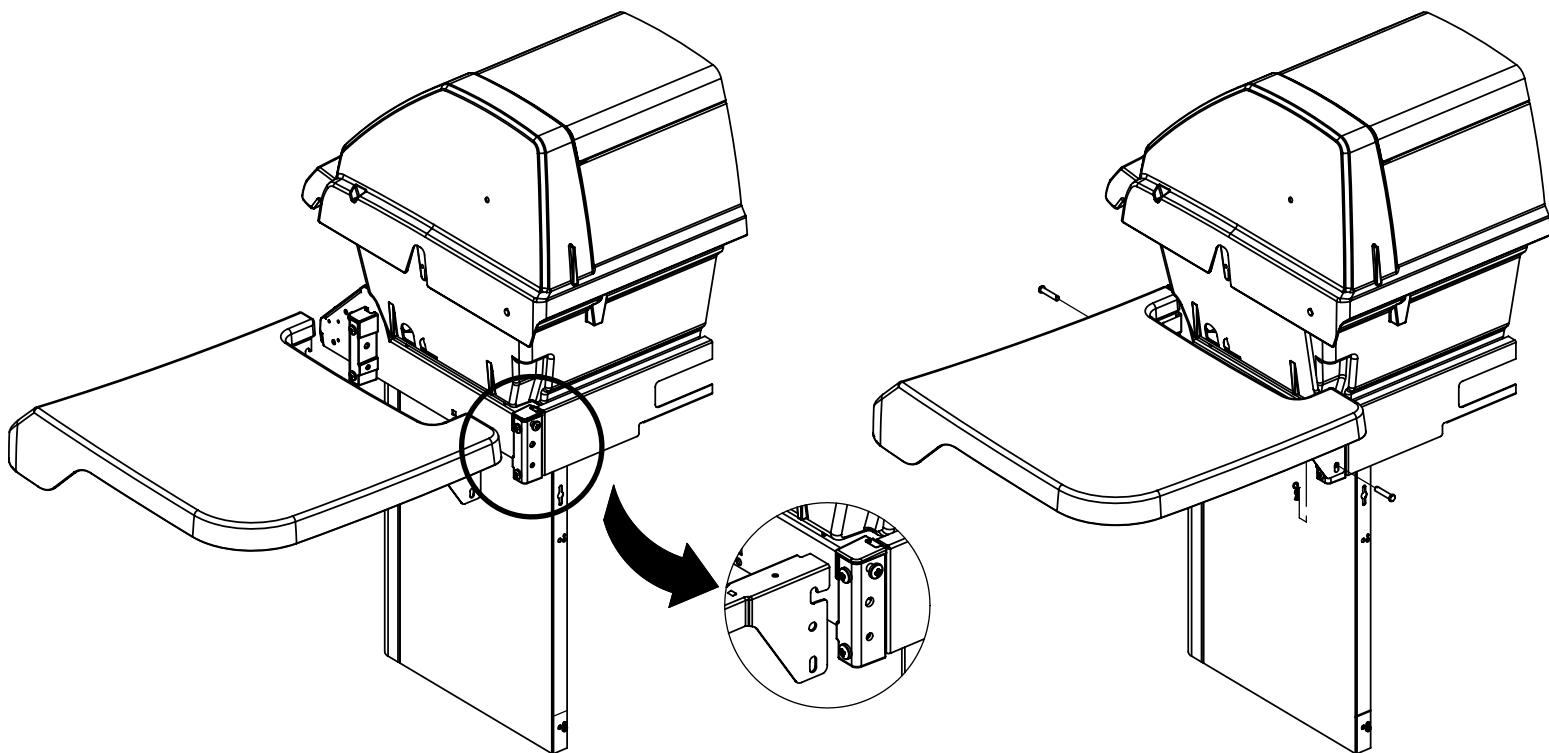

8

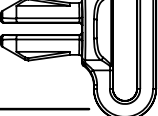
(2) 

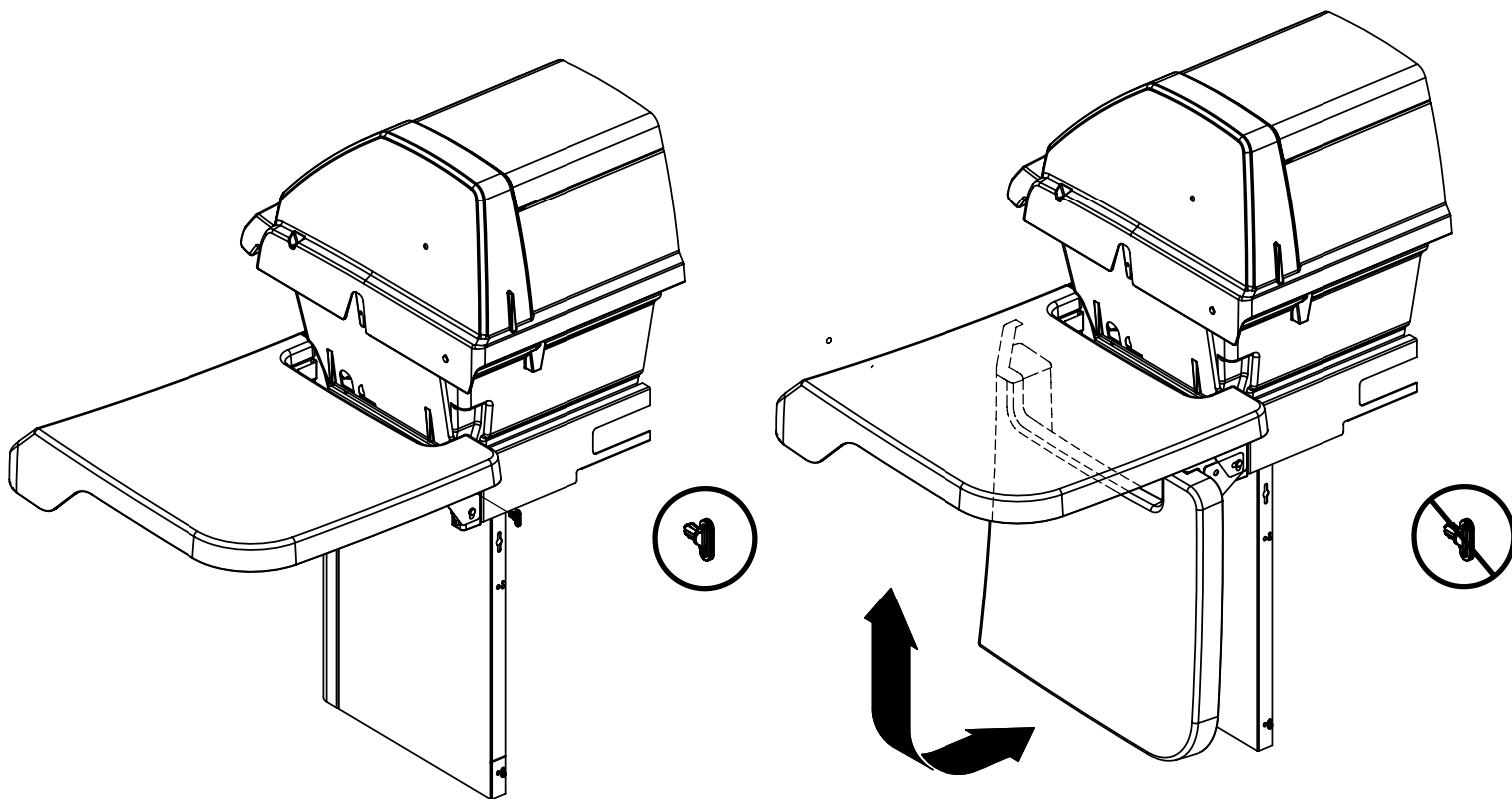

9

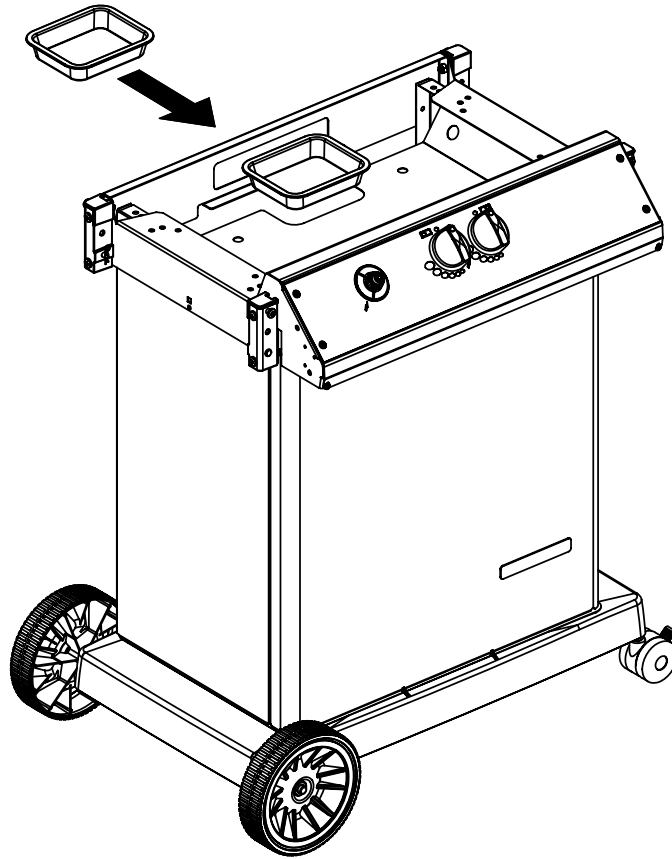

10

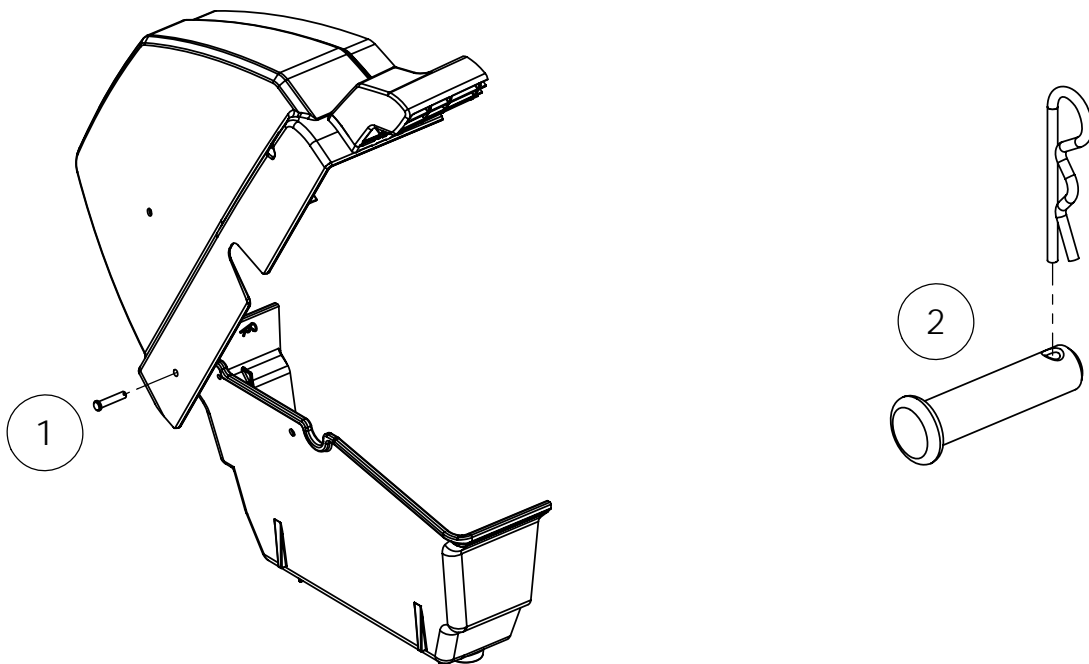
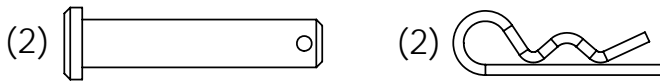



11

(2)

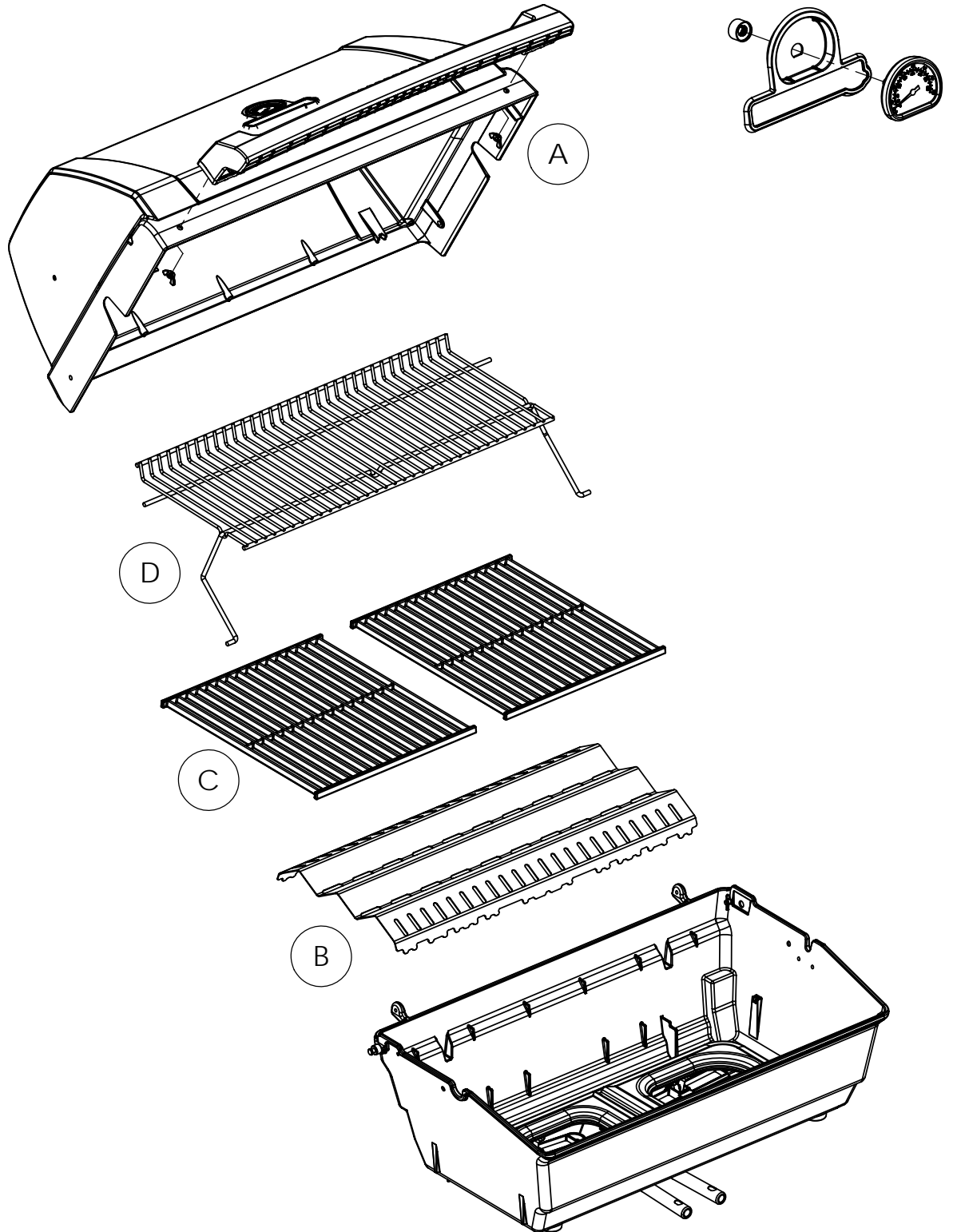
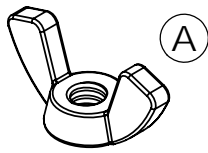

## PARTS LIST / LISTE DES PIECES / TEILELISTE

KEY #	ITEM #	DESCRIPTION	DESCRIPTION	9956-54	9956-57	9956-54B	9956-57B	9959-54	9959-57
1	34120194	CASTING BOTTOM	FOND DU FOYER	1	1	1	1	1	1
2	10473-E394	CASTING TOP	COUVERCLE DU GRIL	1	1	1	1	1	1
3	10081-BK603	NAMEPLATE	PLAQUE D'IDENTIFICATION	1	1	1	1	1	1
3A	10081-BK601	NAMEPLATE	PLAQUE D'IDENTIFICATION	1	1	1	1	1	1
4	10958-E395	TOP CASTING INSERT	PANNEAU DE COUVERCLE	1	1	1	1	1	1
5	10571-6	HEAT INDICATOR	INDICATEUR DE CHALEUR	1	1	1	1	1	1
6	10240-15	HINGE PIN	GOUPILLE DE CHARNIÈRE	6	6	6	6	6	6
6A	S21237	HINGE SPACER	ENTRETOISE DE CHARNIÈRE	2	2	2	2	2	2
7	S21233	HITCH PIN CLIP	ATTACHE DE CHEVILLE	6	6	6	6	6	6
9	38170121	GRID - PORCELAIN	GRILLE	2	2	2	2	2	2
10	10222-T425	FLAV-R-WAVE	FLAV-R-WAVE	1	1	1	1	1	1
11	10225-E390	GRID - WARMING RACK	GRILLE	1	1	1	1	1	1
15	S10017	BURNER/VENTURI ASSY	ENSEMBLE DE BRULEUR	•	•	•	•	1	1
	10390-T501	BURNER/VENTURI ASSY	ENSEMBLE DE BRULEUR	1	1	1	1	•	•
17	10342-244	IGNITOR	ALLUMEUR	1	1	1	1	1	1
18	S15500	ELECTRODE	ELECTRODE	•	•	•	•	1	1
	10342-T301	ELECTRODE	ELECTRODE	1	1	1	1	•	•
21	10440-T50	CONTROL ASSY	SOUPAPE	1	•	1	•	1	•
	10440-T51	CONTROL ASSY	SOUPAPE	•	1	•	1	•	1
22	10114-20	HOSE & REGULATOR LP – QCC1	TUYAU ET REGULATEUR PL – QCC1	1	•	1	•	1	•
	10111-K47	HOSE NATURAL GAS	TUYAU (GAZ NAUTREL)	•	1	•	1	•	1
23	10472-K37	CONTROL KNOB	BOUTON DE CONTROLE	2	2	2	2	2	2
30	10086-E507	DECO PLATE	PLAQUE DECORATIVE	1	1	1	1	•	•
	10086-E516	DECO PLATE	PLAQUE DECORATIVE	•	•	•	•	1	1
31	10194-E501	CONTROL COVER	PANNEAU DE CONTROLE	1	1	1	1	1	1
33	10184-R80	RADIATION SHIELD	ÉCRAN DE CHALEUR	1	1	1	1	1	1
35	10184-E401	SUPPORT-CASTING-LEFT	SUPPORT GAUCHE DU FOYER	1	1	1	1	1	1
36	10184-E411	SUPPORT-CASTING-RIGHT	SUPPORT DROIT DU FOYER	1	1	1	1	1	1
37	10184-E461	SUPPORT-SIDE SHELF-LEFT	SUPPORT TABLETTE DE GAUCHE	2	2	2	2	2	2
37A	10184-E62	SUPPORT-SIDE SHELF-LEFT	SUPPORT TABLETTE DE GAUCHE	2	2	2	2	2	2
38	10184-E471	SUPPORT-SIDE SHELF-RIGHT	SUPPORT TABLETTE DE DROIT	2	2	2	2	2	2
38A	10184-E63	SUPPORT-SIDE SHELF-RIGHT	SUPPORT TABLETTE DE DROIT	2	2	2	2	2	2
39	10956-E561	BRACE-REAR	SUPPORT ARRIERE	1	1	1	1	1	1
40	10958-R81B	BASE	TABLETTE INFERIEURE	1	1	1	1	1	1
41	10956-E571	BRACE-FRONT	SUPPORT AVANT	1	1	1	1	1	1
42	10958-K881	FRONT PANEL	PANNEAU	1	1	•	•	•	•
	10958-K882	FRONT PANEL	PANNEAU	•	•	1	1	1	1
43	10958-E861	SIDE PANEL BLK	PANNEAU LATERALE	2	2	•	•	•	•
	10958-E862	SIDE PANEL BLACK CHROME	PANNEAU LATERALE	•	•	2	2	2	2
47	10184-R19	TANK RETAINER	SERVITEUR DU RESERVOIR	2	•	2	•	2	•
50	10711-E561	SHELF - SIDE - RIGHT	PLANCHETTE LATERALE – DROIT	1	1	1	1	1	1
51	10711-E562	SHELF - SIDE - LEFT	PLANCHETTE LATERALE – GAUCHE	1	1	1	1	1	1
56	10892-7	WHEEL	ROUE	2	2	2	2	2	2
73	S21420	PUSH NUT	POUSSE ECROU	2	2	2	2	2	2
75	10338-390	HANDLE	POIGNÉE	1	1	1	1	1	1
78	10892-13	CASTOR	ROULETTES	2	2	2	2	2	2
79	Y-11561	BOLT – 1/4:20 x 1 3/4	BOULON - 1/4:20 X 1 3/4	8	8	8	8	8	8
80	Y-11546	SCREW- 1/4-20 X 5/8	VIS – 1/4-20 X 5/8	4	4	4	4	4	4
81	Y-11545	SCREW – 1/4-20 X 1 3/8	VIS – 1/4-20 X 1 3/8	4	4	4	4	4	4
82	Y-12673	SHELF - LOCK PIN	ÉTAGÈRE - GOUPILLE DE SERRURE	2	2	2	2	2	2
83	S21014	BOLT- 1/4-20 X 3/4	BOULON – 1/4-20 X 3/4	8	8	8	8	8	8
84	S15171	AXLE	ESSIEU	1	1	1	1	1	1
87	Y-11793	NUT- 1/4-20	ECROU – 1/4-20	20	20	20	20	20	20
88	Y-11598	WING NUT - 1/4-20	ECROU – 1/4-20	2	2	2	2	2	2
96	S21125	SCREW – 8 X 1/2	VIS - 8 X 1/2	4	4	4	4	4	4
98	S21124	SCREW – 8 X 1/2	VIS - 8 X 1/2	18	18	18	18	18	18
109	S21136	SCREW – 8-32 X 3/8	VIS – 8-32 X 3/8	3	1	3	1	3	1
115	Y-29304	SCREW – 10-24 X 3/8	VIS– 10-24 X 3/8	2	2	2	2	2	2
123	S15115	GREASE PAN - DISPOSABLE	CUVETTE A GRAISSE	1	1	1	1	1	1

