



**IMPORTANT INSTRUCTIONS
SAVE THESE INSTRUCTIONS**

**MODE D'EMPLOI IMPORTANT
CONSERVEZ LES PRESENTES INSTRUCTIONS**

**INSTRUCCIONES IMPORTANTES
REPASE Y GUARDE ESTAS INSTRUCCIONES
LEA ESTE INSTRUCTIVO ANTES DE UTILIZAR EL APARATO**

**ISTRUZIONI IMPORTANTI
CONSERVARE LE ISTRUZIONI**



**COFFEE MAKER TYPE BAR 32/CAFETERIE MODÈLE BAR 32/CAFETERA ELECTRICA MODELO BAR 32/
MACCHINA DA CAFFÈ BAR32**

Register this product on-line and receive a free trial issue of Cook's Illustrated. Visit www.prodregister.com/delonghi.
Visit www.delonghi.com for a list of service centers near you. (U.S. and Canada)

Enregistrez ce produit en ligne et recevez un numéro gratuit de Cook's Illustrated. Visitez www.prodregister.com/delonghi.
Visitez www.delonghi.com pour y voir une liste des centres de réparation proches de chez vous. (É.-U. et Canada).

Registre este producto en línea y reciba un ejemplar gratis de Cook's Illustrated. Visite www.prodregister.com/delonghi.
Visite www.delonghi.com para ver la lista de centros de servicios cercanos a usted. (Estados Unidos y Canada)

Registra questo prodotto "on-line" per ricevere una copia omaggio della rivista. Visita www.prodregister.com/delonghi.
Visita www.delonghi.com per una lista dei centri di servizio a te più vicini. (Stati Uniti e Canada)

**ELECTRONIC CHARACTERISTICS: CARACTÉRISTIQUES ÉLECTRIQUES: CARACTERISTICAS ELECTRICAS:
CARATTERISTICHE ELETTRICHE: 120V-60HZ 1100W**

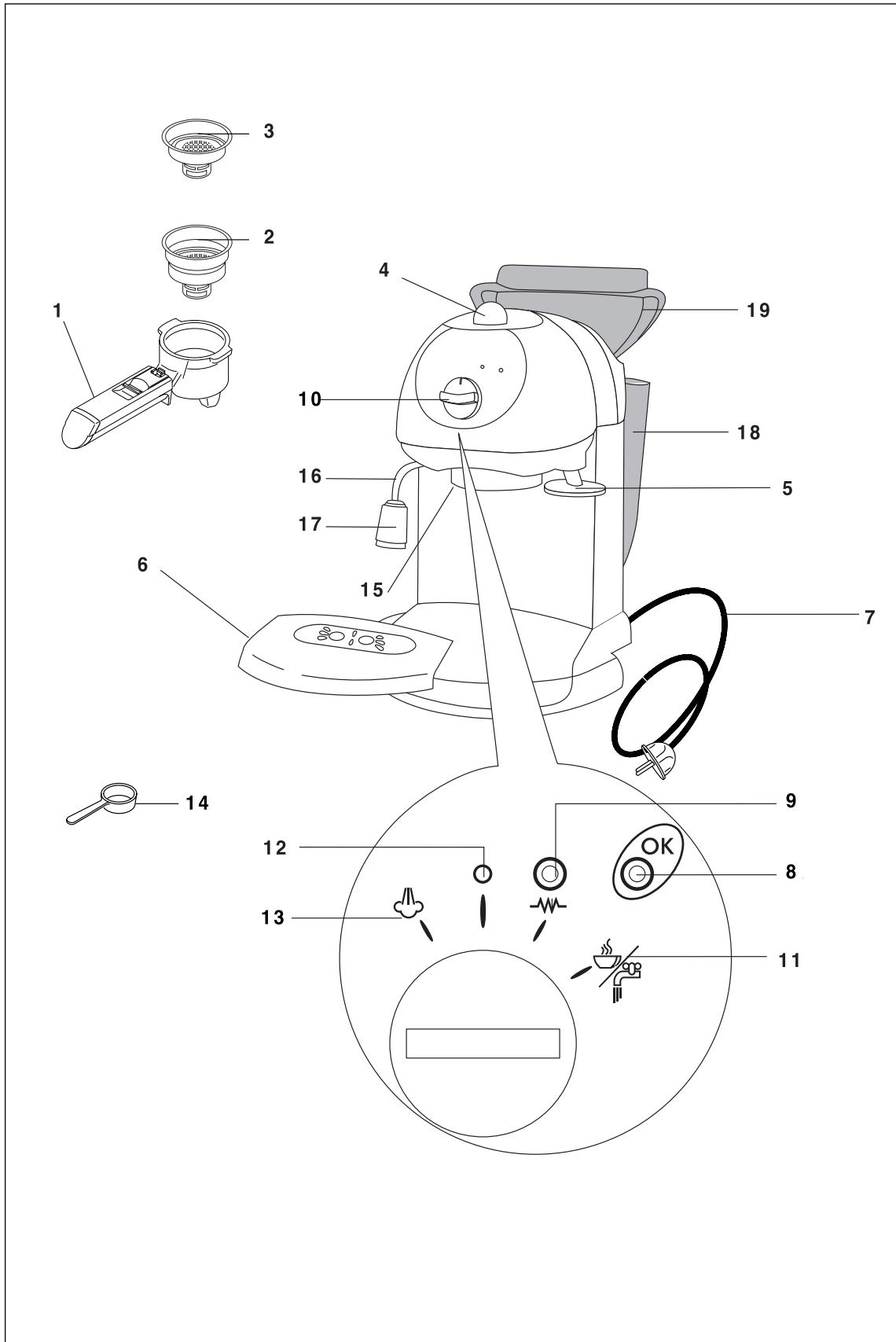

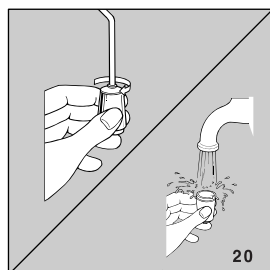
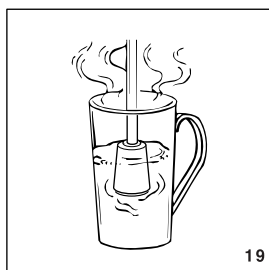
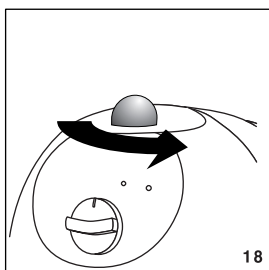
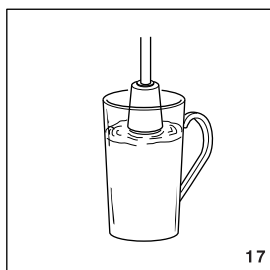
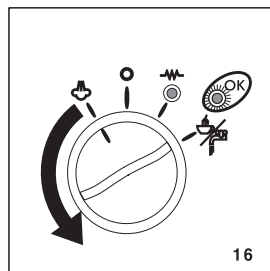
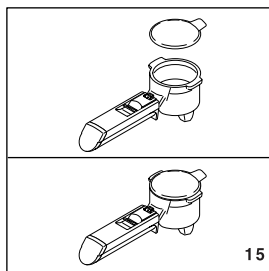
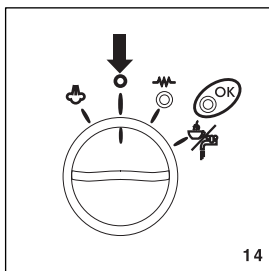
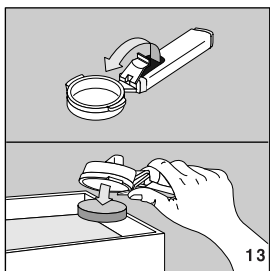
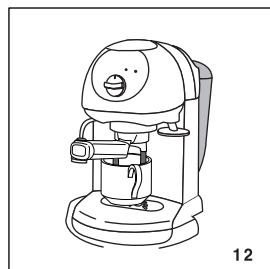
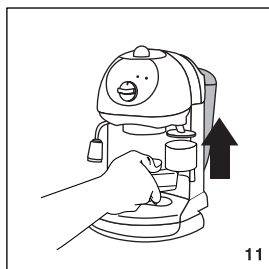
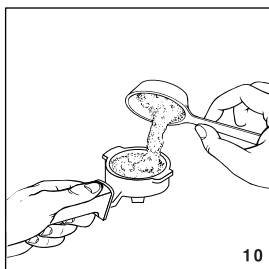
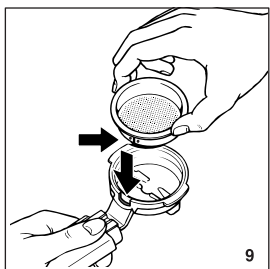
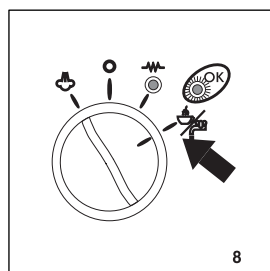
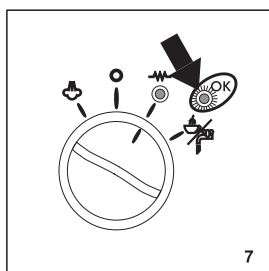
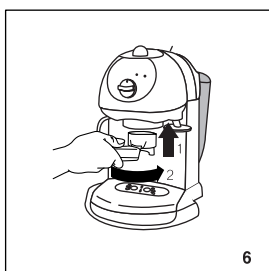
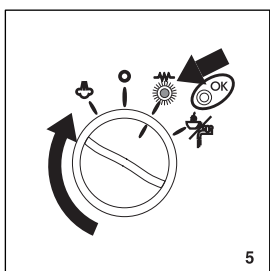
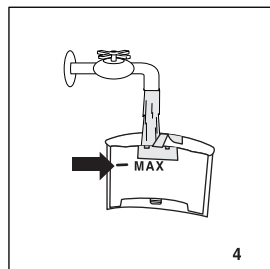
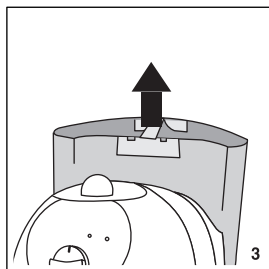
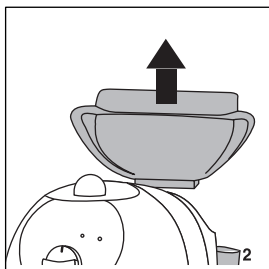
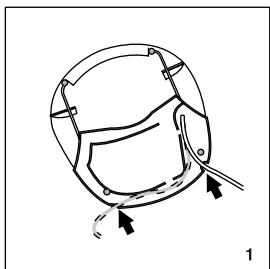

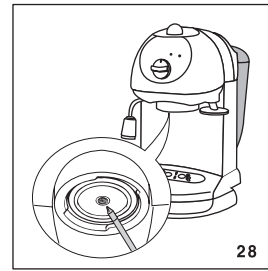
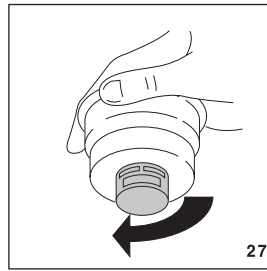
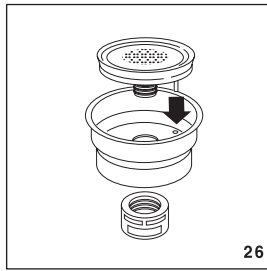
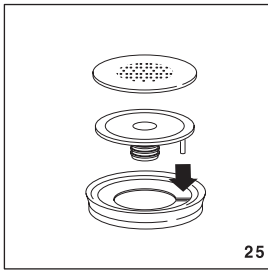
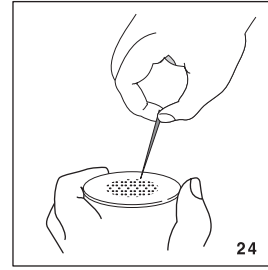
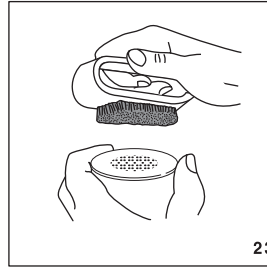
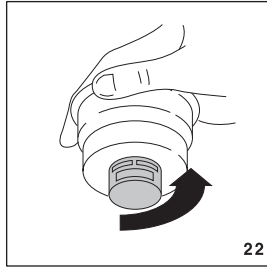
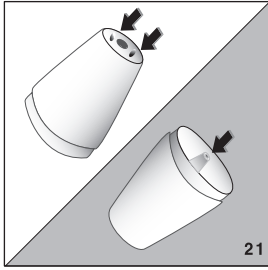



IMPORTANT SAFEGUARDS

When using electrical appliances, basic safety precautions should always be followed, including the following:

- Read all instructions.
- Do not touch hot surfaces. Use handles and knobs.
- To protect against fire, electrical shock and personal injury, do not immerse cord, plug or appliance in water or other liquid.
- Never allow the appliance to be used by children
- Unplug from the outlet when not in use and before cleaning. Allow to cool before fitting or taking off parts, and before cleaning the appliance.
- Do not operate with a damaged cord or plug, or after the appliance malfunctions, or has been damaged in any manner. Return the appliance to the nearest authorized service facility for examination, repair or adjustment.
- The use of accessory attachments or spare parts not recommended by the appliance manufacturer may result in fire, electrical shock or personal injury.
- Do not use outdoors.
- Do not let the cord hang over the edge of the table or counter, or touch hot surfaces.
- Do not place on or near a hot gas or electrical burner, or in a heated oven.
- Plug cord into the wall outlet. To disconnect, turn any control to "off", then remove plug from wall outlet.
- Do not use the appliance for other than the intended use. This appliance is to be utilized for domestic use only. Any other use is to be considered improper and therefore, dangerous.
- DO NOT unscrew or remove boiler cap while the machine is in operation. Wait until brewing cycle is completed and all water and steam has been used up.

SAVE THESE INSTRUCTIONS

THIS PRODUCT IS FOR HOUSEHOLD USE ONLY

SHORT CORD INSTRUCTIONS

- A short power cord is provided to reduce risks resulting from becoming entangled in or tripping over a longer cord.
- Longer, detachable power supply cords or extension cords are available and may be used if care is exercised in their use.
- If an extension cord is used, the marked electrical rating should be at least as great as the electrical rating of the appliance. If the appliance is provided with 3- wire, grounding type cord, the extension should be a GROUNDING TYPE 3 - WIRE CORD. The longer cord should be arranged so that it will not drape over the counter-top or table top where it can be pulled on by children or tripped over.
- Your product is equipped with a polarized alternating current line plug (a plug having one blade wider than the other). This plug will fit into the power outlet only one way. This is a safety feature. If you are unable to insert the plug fully into the outlet, try reversing the plug. If the plug should still fail to fit, contact your electrician to replace your obsolete outlet. Do not defeat the safety purpose of the polarized plug.



Read this manual thoroughly before installing and using the appliance.

This is the only way to ensure best results and maximum safety for the user.

DESCRIPTION

(see figure on page 3).

The terminology below will be used repeatedly on the following pages.

- 1 One filter holder
- 2 Large filter for 2 cups ground coffee
- 3 Small filter for 1 cup ground coffee or 1 pod
- 4 Steam knob
- 5 Tamper
- 6 Cup tray
- 7 Power cable
- 8 Temperature OK light (coffee/hot water or steam)
- 9  light (appliance on)
- 10 Function selector knob
- 11  position to run off coffee/hot water
- 12  position
- 13 Steam position
- 14 Coffee measure
- 15 Boiler outlet
- 16 Steam/hot water tube
- 17 Jet frother
- 18 Water tank
- 19 Water tank lid

SAFETY WARNINGS

- This appliance is designed to "make espresso coffee" and "hot drinks". Use with care to avoid scalds from the water and steam jets or through incorrect use.
- Never touch hot parts.
- After removing the packaging, make sure the product is complete. If in doubt, do not use the appliance and contact a De'Longhi Customer Service.
- The packing elements (plastic bags, polystyrene foam, etc.) should be kept out of the reach of children as they are a safety hazard.
- This appliance is intended for domestic use only. Any other use is considered improper and thus dangerous.
- The manufacturer cannot be held responsible for any damage caused through incorrect, wrong or unreasonable use.
- Never touch the appliance with wet or damp hands.
- Never let children use the appliance without supervision.
- Never allow children to play with the appliance.
- In the event of malfunction or faulty operation, switch off and do not attempt to repair.

- If it requires repair, contact an authorized service center only and ask for original spare parts to be used.
- Failure to respect the above could reduce the safety of the appliance.
- The power cable for this appliance must not be replaced by the user as this operation requires the use of special tools.
- If the cable is damaged or requires replacing, contact an authorized service center only to avoid all risks.

INSTALLATION

- Place the appliance on a work surface away from taps and sinks.
- Check that the voltage of the power supply corresponds to the value indicated on the appliance rating plate.
- Connect the appliance to an efficiently grounded outlet with a minimum current rating of 10 A only.
- The manufacturer may not be considered liable for possible incidents caused by the failure to adequately ground the outlet.
- If the plug fitted to the appliance does not match the power outlet, have the outlet replaced with a suitable type by a qualified professional.
- Never install the appliance in environments where the temperature may reach 0°C (32°F) or lower (the appliance may be damaged if the water freezes).
- If the power cable is longer than the distance required to reach the mains outlet, the extra length can be stored inside the appliance by pushing the cable back through the cable opening.
- The power cable can be positioned to the right or left according to the location of the nearest outlet, resting it in the guides on the bottom of the appliance (fig. 1).

When the power cable is in the required position, make sure it is correctly held in place by the clips on the bottom of the appliance (fig. 1).

HOW TO MAKE ESPRESSO COFFEE

FILLING THE WATER TANK

Remove the water tank lid (fig. 2) and then take out the tank by pulling upwards (fig. 3).

Fill the tank with fresh clean water taking care not to exceed the MAX level (fig. 4).

Replace the tank, pressing lightly to open the valve located on the bottom of the tank.

More simply, the tank can also be filled without removing it, pouring the water directly from a jug.

IMPORTANT: It is normal for there to be water in the space under the tank. This should therefore be dried regularly with a clean sponge.

Note: Never use the appliance without water in the tank and always remember to top up when the level drops to about an inch from the bottom.



PREHEATING THE COFFEE UNIT

To obtain espresso coffee at the ideal temperature, it is recommended that the coffee machine be preheated.

Turn the selector knob to the  position (fig. 5) before making coffee, making sure the filter holder is attached to the appliance (check that the steam knob is closed).

To attach the filter holder, position it under the boiler outlet with the handle towards the left (see fig. 6), push it upwards and at the same time rotate the handle towards the right. **Rotate firmly.** Wait until the preheating process is complete, and then make coffee as described in the following chapter.

Alternatively, preheating can be achieved more rapidly proceeding as follows:

1. Turn the appliance on by rotating the selector knob to the  position (fig. 5) and attach the filter holder to the appliance **without adding ground coffee.**
2. Place a cup under the filter holder. Use the same cup as will be used to prepare the coffee in order to preheat it.
3. Wait for the OK indicator light to come on (fig. 7), then immediately rotate the selector knob to the  position (fig. 8), run the water off until the OK indicator light goes out, then interrupt delivery by rotating the selector knob to the  position (fig. 5).
4. Empty the cup. Wait until the OK indicator light comes on again then repeat the same operation.

HOW TO PREPARE ESPRESSO COFFEE USING THE FILTER FOR GROUND COFFEE

1. After preheating the appliance as described above, place the ground coffee filter in the filter holder, making sure the projection is correctly inserted in the slot as shown in fig. 9. For appliances with two filters, use the smallest for one coffee and the largest

for two coffees.

2. **To make a single coffee only,** place one level measure of ground coffee, about 7 grams, in the filter (fig. 10).

To prepare two coffees, place two loosely filled measures of ground coffee (about 6+6 g) in the filter.

Fill the filter a little at a time to prevent the ground coffee from overflowing.



IMPORTANT: for correct operation, before adding the ground coffee to the filter, clean the filter from residues of ground coffee from the previous infusion.

3. Distribute the ground coffee evenly and press lightly with the tamper (fig. 11). *Note: Correct pressing of the ground coffee is essential to obtain a good espresso. If pressing is excessive, coffee delivery will be slow and the froth will be dark. If pressing is too light, coffee delivery will be too rapid and the froth will be skimpy and light colored.*

4. Remove any excess coffee from the rim of the filter holder and attach the filter holder to the appliance.

Rotate firmly (fig. 6) to avoid leaks of water.

5. Place the cup or cups (ideally preheated by rinsing with a little hot water) under the filter holder spouts (fig. 12).

6. Make sure the OK light (fig. 7) is on (if off, wait until it comes on), then turn the knob to the  position (fig. 8) until the required quantity is obtained. To interrupt, place the selector back in the  position (fig. 5).

7. To remove the filter holder, rotate the handle from right to left.

IMPORTANT: to avoid splashes, never remove the filter holder while the appliance is delivering coffee.

8. To eliminate the used coffee grounds, block the filter in place using the lever incorporated in the handle and empty the coffee by turning the filter holder upside down and tapping (fig. 13).

9. To turn the appliance off, rotate the selector knob to the "O" position (fig. 14).

IMPORTANT: the first time the appliance is used, all accessories must be washed thoroughly by making at least five coffees without using ground coffee.

HOW TO PREPARE ESPRESSO COFFEE USING PODS (FOR APPLIANCES WITH TWO FILTERS ONLY)

1. Preheat the appliance as described in the section "PREHEATING THE COFFEE UNIT", making sure the filter holder is attached.

NOTE: use pods conforming to the ESE standard, indicated on the pack by the following symbol:



The ESE standard is a system accepted by leading pod producers and enables espresso coffee to be prepared simply and cleanly.

2. Place the small 1 coffee or pod filter in the filter holder, making sure the projection is correctly inserted in the slot as shown in fig. 12.
3. Insert a pod, centering it as far as possible on the filter (fig. 15). Always follow the instructions on the pod pack to position the pod on the filter correctly.
4. Attach the filter holder to the appliance. Always rotate as far as it will go (fig. 6).
5. Proceed as in points 5, 6 and 7 in the previous paragraph.

HOW TO MAKE CAPPUCCINO COFFEE

1. Prepare the espresso coffees as described in the previous paragraphs, using sufficiently large cups.
2. Rotate the selector knob to the ☞ position (fig. 16) and wait until the OK light comes on (fig. 7). This indicates that the boiler has reached the ideal temperature for steam production.
3. In the meantime, fill a container with about 3¹/₂ ounces of milk for each cappuccino to be prepared. The milk must be at refrigerator temperature (not hot!). In choosing the size of the container, bear in mind that the milk doubles or triples in volume.

Note: You are recommended to use skim milk at refrigerator temperature.

4. Place the container with milk under the Jet Frother (fig. 17).
5. Immerse the Jet Frother in the milk about 1/4 of an inch and rotate the steam knob counter-clockwise (fig. 18) (rotating the knob more or less varies the quantity of steam discharged by the Jet Frother). The milk now starts to increase in volume and take on a creamy appearance.
6. When the milk has doubled in volume, immerse the Jet Frother deeply and continue heating the milk (fig. 19). When the required temperature is reached (the ideal is 60°C - 140°F), interrupt steam delivery by rotating the steam knob clockwise and placing the selector in the "O" position (fig. 14).

7. Pour the frothed milk into the cups containing the espresso coffee prepared previously.

The cappuccino is ready. Sweeten to taste and if desired, sprinkle the froth with a little cocoa powder.

Note: to make coffee again after the milk has been frothed, cool down the boiler first or the coffee will burn. To cool, place a container under the boiler outlet, turn the selector to the "coffee" position and run off the water until the OK light goes out. Turn the selector back to the ☞ position and make the coffee as described above.

IMPORTANT: always clean the Jet Frother after use. Proceed as follows:

1. Discharge a little steam for a few seconds by rotating the steam knob (fig. 18).
2. Wait several minutes for the steam tube to cool down. Unscrew the cappuccino maker by rotating clockwise (fig. 20) and wash thoroughly with warm water.
3. Make sure the three holes in the cappuccino maker shown in fig. 21 are not blocked. If necessary, clean with a pin.
4. Clean the steam tube, taking care to avoid burns.
5. Screw the cappuccino maker back in place.

HOT WATER PRODUCTION

1. Turn the appliance on by rotating the selector knob to the ☞ position (fig. 5).
2. Place a container under the cappuccino maker.
3. When the OK indicator light comes on, turn the selector knob to the ☞ position (fig. 8) and at the same time, rotate the steam knob counter-clockwise (fig. 18). Hot water is delivered from the Jet Frother.
4. To interrupt delivery of hot water, rotate the steam knob clockwise and position the selector knob to "O" (fig. 14).

CLEANING AND MAINTENANCE OF THE FILTER

About every 300 coffees or when the coffee drips out of the filter holder or not at all, clean the ground coffee filter holder as follows:

- Remove the filter from the filter holder.
- Remove the filter cap (fig. 22) by unscrewing in the direction indicated by the arrow on the cap.
- Remove the frother from the container by pushing it from the cap end.
- Remove the gasket (fig. 25).
- Rinse all components and clean the metal filter thoroughly in hot water using a brush (fig. 23). Make sure the holes in the metal filter are not blocked. If necessary, clean with a pin (see fig. 24).

- Replace the filter and gasket on the plastic disk as shown in fig. 25.
Make sure to insert the pin on the plastic disk into the hole in the gasket indicated by the arrow in fig. 25.
- Replace the assembly in the steel filter container (fig. 26), making sure the pin is inserted into the hole in the support (see arrow in fig. 26).
- Finally, screw on the cap (fig. 27).

Failure to clean as described above invalidates the resulting.

CLEANING THE BOILER OUTLET

About every 300 coffees, the espresso boiler outlet must be cleaned as follows:

- Make sure the appliance is not hot and that it is unplugged from the outlet.
- Using a screwdriver, unscrew the screw fixing the espresso boiler outlet filter (fig. 28).
- Clean the outlet filter thoroughly in hot water using a brush. Make sure the holes are not blocked. If necessary, clean with a pin.

Failure to clean as described above invalidates the resulting.

OTHER CLEANING OPERATIONS





1. Do not use solvents or abrasive cleaning products to clean the appliance. A soft, damp cloth is sufficient.
2. Remove the drip tray, empty and wash frequently.
3. Clean the water tank regularly.

IMPORTANT: during cleaning, never immerse the coffee machine in water. It is an electrical appliance.

DESCALING

You are recommended to descale the coffee machine about every 200 coffees.

You should use a commercially available product specifically for descaling espresso coffee machines. If such a product is not available, proceed as follows.

1. Fill the tank with one litre of water.
2. Dissolve 2 spoonfuls (about 1 ounce) of citric acid.
3. Rotate the selector knob to the  position and wait until the OK indicator light comes on.
4. Make sure the filter holder is not attached and position a container under the boiler outlet.
5. Rotate the selector knob to the  position (fig. 8) and run off half the solution in the tank.
Then interrupt the flow by rotating the selector to the "O" position (fig. 14).
6. Leave the solution to work for about 15 minutes, then run off the rest of the water in the tank.
7. To eliminate residues of solution and scale, rinse the tank well, fill with clean water and replace.
8. Rotate the selector knob to the  position (fig. 8) and run off the water until the tank is completely empty;
9. Rotate the selector knob to the  position (fig. 5) and repeat operations 7 and 8 again.

Repair of damage to the coffee machine caused by scale is not covered by the resulting unless descaling is performed regularly as described above.

PROBLEM	POSSIBLE CAUSES	SOLUTION
<p>No espresso coffee is delivered</p>	<ul style="list-style-type: none"> • Ground coffee too damp and/or packed down too tightly. • No water in the tank • The holes in the filter holder spouts are blocked. • The espresso boiler outlet is blocked. • The filter is blocked • The tank is incorrectly inserted and the valve on the bottom is not open. 	<ul style="list-style-type: none"> • Make the coffee again packing it down less and/or using different ground coffee. • Fill the tank with water. • Clean the spout holes • Clean as described in the chapter "Cleaning the boiler outlet". • Clean as described in the section "Cleaning the filter". • Press the tank down lightly to open the valve on the bottom.
<p>The espresso coffee drips from the edges of the filter holder rather than the holes</p>	<ul style="list-style-type: none"> • The filter holder is inserted incorrectly. • The espresso boiler gasket has lost elasticity. • The holes in the filter holder spouts are blocked. 	<ul style="list-style-type: none"> • Attach the filter holder correctly and rotate firmly as far as it will go. • Have the espresso boiler gasket replaced at a service center. • Clean the spout holes
<p>The espresso coffee is cold</p>	<ul style="list-style-type: none"> • The espresso OK indicator light was not on when the coffee switch was pressed. • No preheating performed • The cups were not preheated 	<ul style="list-style-type: none"> • Wait until the espresso OK indicator light comes on. • Preheat as described in the paragraph "Preheating the espresso coffee unit". • Preheat the cups.
<p>The pump is excessively noisy</p>	<ul style="list-style-type: none"> • The water tank is empty. • The tank is incorrectly inserted and the valve on the bottom is not open. 	<ul style="list-style-type: none"> • Refill the tank. • Press the tank down lightly to open the valve on the bottom.
<p>The coffee froth is too light (delivered from the spout too fast)</p>	<ul style="list-style-type: none"> • The ground coffee is not pressed down firmly enough. • There is not enough ground coffee. • The ground coffee is too coarse • Incorrect type of ground coffee. 	<ul style="list-style-type: none"> • Press the ground coffee down more firmly (fig. 11). • Increase the quantity of ground coffee. • Use ground coffee for espresso coffee machines only. • Change the type of ground coffee.
<p>The coffee froth is too dark (delivered from the spout too slowly)</p>	<ul style="list-style-type: none"> • The ground coffee is pressed down too firmly. • There is too much ground coffee. • The espresso boiler outlet is blocked. • The filter is blocked • The ground coffee is too fine. • The ground coffee is too fine or is damp. • Incorrect type of ground coffee. 	<ul style="list-style-type: none"> • Press the coffee down less firmly (fig. 11). • Reduce the quantity of ground coffee. • Clean as described in the chapter "Cleaning the espresso boiler outlet". • Clean as described in the section "Cleaning the filter". • Use ground coffee for espresso coffee machines only. • Use ground coffee for espresso coffee machines only and make sure it is not damp. • Change the type of ground coffee.
<p>No milk froth is formed when making cappuccino</p>	<ul style="list-style-type: none"> • Milk not cold enough. • Jet Frother dirty. 	<ul style="list-style-type: none"> • Always use skim milk at refrigerator temperature. • Thoroughly clean the holes in the Jet Frother in particular those indicated in figure 21.



This warranty applies to all products with De'Longhi or Kenwood brand names.

LIMITED WARRANTY

What does the warranty cover?

We warrant each appliance to be free from defects in material and workmanship. Our obligation under this warranty is limited to repair at our factory or authorized service center of any defective parts or part thereof, other than parts damaged in transit. In the event of a products replacement or return, the unit must be returned transportation prepaid. The repaired or new model will be returned at the company expense.

This warranty shall apply only if the appliance is used in accordance with the factory directions, which accompany it, and on an Alternating current (AC) circuit.

How long does the coverage last?

This warranty runs for one year (1) from the purchase date found on your receipt and applies only to the original purchaser for use.

What is not covered by the warranty?

The warranty does not cover defects or damage of the appliance, which result from repairs or alterations to the appliance outside our factory or authorized service centers, nor shall it apply to any appliance, which has been subject to abuse, misuse, negligence or accidents. Also, consequential and incidental damage resulting from the use of this product or arising out of any breach of contract or breach of this warranty are not recoverable under this warranty. Some states do not allow the exclusion or limitation of incidental or consequential damage, so the above limitation may not apply to you.

How do you get service?

If repairs become necessary, see contact information below:

U.S. Residents:

Please contact our toll free hotline at 1-800-322-3848 or log onto our website at www.delonghi.com.

For all accessories, spare parts or replacement parts, please contact our parts division at 1-800-865-6330.

Residents of Canada:

Please contact our toll free hotline at 1-888-335-6644 or log onto our website at www.delonghi.com.

Residents of Mexico:

Please refer to the Limited Warranty statement for Mexico.

Please refer to the back page of the manual for De'Longhi addresses.

The above warranty is in lieu of all other express warranties and representations. All implied warranties are limited to the applicable warranty period set forth above. This limitation does not apply if you enter into an extended warranty with De'Longhi. Some states do not allow limitations on how long an implied warranty lasts, so the above exclusions may not apply to you. De'Longhi does not authorize any other person or company to assume for it any liability in connection with the sale or use of its appliance.

How does state law apply?

This warranty gives you specific legal rights, and you may also have other rights, which vary from state to state.