

This Owner's Manual is provided and hosted by [Appliance Factory Parts](#).



DE'LONGHI DCU500T Owner's Manual

[Shop genuine replacement parts for DE'LONGHI
DCU500T](#)



[Find Your DE'LONGHI Coffee Maker Parts - Select From 289 Models](#)

----- Manual continues below -----



De'Longhi America, Inc.
Park 80 West, Plaza One
Saddle Brook, NJ 07663
800-322-3848

De'Longhi Canada, Inc.
6150 McLaughlin Road
Mississauga, Ontario
L5R 4E1 Canada
800-322-3848

FIDUCIA ITALIANA S.A DE C.V
Pestalozzi #814
Col. Narvarte
Del. Benito Juarez
C.P. 03100
tels: 5543 1447
lada sin costo: 01 800 711 8805

www.delonghi.com

**IMPORTANT INSTRUCTIONS
SAVE THESE INSTRUCTIONS**



**MODE D'EMPLOI IMPORTANT
CONSERVEZ LES PRESENTES INSTRUCTIONS**

**INSTRUCCIONES IMPORTANTES
LEA CUIDADOSAMENTE ESTE INSTRUCTIVO ANTES
DE USAR SU APARATO
REPASE Y GUARDE ESTAS INSTRUCCIONES**

**ISTRUZIONI IMPORTANTI
CONSERVARE LE ISTRUZIONI**

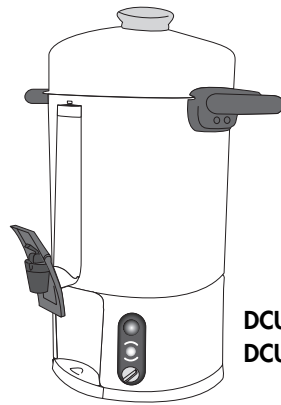

**DCU500T / DCU600T /
DCU720**

**STAINLESS STEEL COFFEE URN / FONTAINE A CAFE /
CAFETERA A PRESION / CAFFETTIERA GRANDE**

Register this product on-line and receive a free trial issue of Cook's Illustrated. Visit www.delonghiregistration.com.
Visit www.delonghi.com for a list of service centers near you. (U.S. and Canada only)

Enregistrez ce produit en ligne et recevez un numéro gratuit de Cook's Illustrated. Visitez www.delonghiregistration.com
Visitez www.delonghi.com pour y voir une liste des centres de réparation proches de chez vous. (É.-U. et Canada).

Registre este producto en línea y reciba un ejemplar gratis de Cook's Illustrated. Visite www.delonghiregistration.com
Visite www.delonghi.com para ver la lista de centros de servicios cercanos a usted. (Estados Unidos y Canada)

Registra questo prodotto "on-line" per ricevere una copia omaggio della rivista. Visita www.delonghiregistration.com
Visita www.delonghi.com per una lista dei centri di servizio a te più vicini. (Stati Uniti e Canada)

**ELECTRONIC CHARACTERISTICS: CARACTÉRISTIQUES ÉLEC-
TRIQUES: CARACTERISTICAS ELECTRICAS: CARATTERISTICHE ELET-
TRICHE: 120V-60Hz 1 400W**

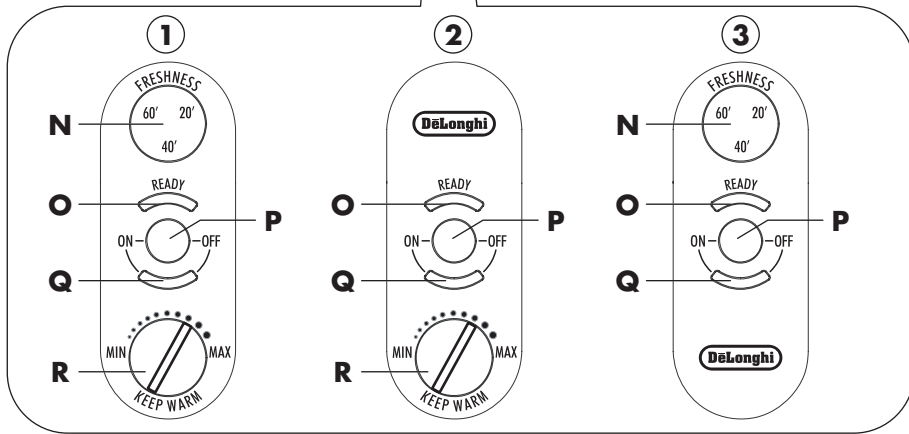
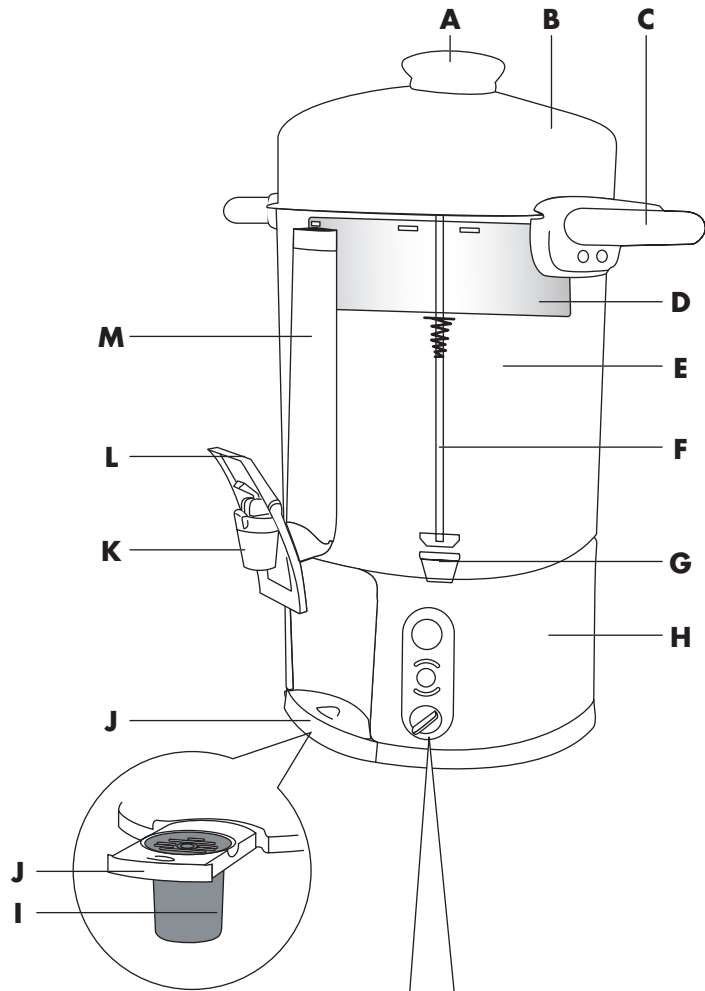

IMPORTANT SAFEGUARDS

When using any electrical appliance, some basic safety precautions should be observed. Specifically:

- Read all instructions carefully.
- Make sure the voltage of your electrical system corresponds to the voltage shown on the bottom of the machine.
- Do not touch hot surfaces. Use handles or knobs.
- To protect against fire, electrical shock and personal injury, do not immerse cord, plug, or appliance in water or other liquid.
- Keep the appliance out of the reach of children and do not leave appliance unattended while in operation.
- Disconnect the plug from the power outlet when the machine is not in use and before cleaning.
- Do not operate the machine with a damaged cord or plug, after faulty operation, or when it has been damaged in any way. Contact the nearest De'Longhi service facility for examination, repair or adjustment.
- The use of accessories not recommended by the manufacturer may result in fire, electrical shock, or personal injury.
- Do not use the machine outdoors.
- Make sure the power cord does not hang over the edge of the table or counter-top to avoid getting accidentally caught or entangled.
- Do not place the machine or its electrical parts on or near electric stoves, cooking surfaces, or gas burners.
- To disconnect the appliance remove plug from wall outlet.
- Do not use this machine for any purpose other than its intended use. This appliance is for commercial and household use. The manufacturer declines all responsibility for any damage caused by improper, incorrect, or irresponsible use.

SAVE THESE INSTRUCTIONS

THIS APPLIANCE IS FOR COMMERCIAL AND HOUSEHOLD USE.

SHORT CORD INSTRUCTIONS

A short power cord is provided to reduce the risk resulting from entanglement or tripping over a longer cord. Longer detachable power supply cords are available and may be used if care is exercised in their use. If a longer detachable power cord or extension cord is used (1) the marked electrical rating of the extension cord should be at least as great as the electrical rating of the appliance, and (2) the longer cord should be arranged so that it will not drape over the countertop or table top where it can be pulled on by children or tripped over unintentionally. The electrical rating of the appliance is listed on the bottom of the unit. If the appliance is of the grounded type, the extension cord should be a grounded type 3 wire cord. This appliance has a polarized plug. One blade is wider than the other. To reduce the risk of electrical shock this plug will fit in a polarized plug only one way. If the plug does not fit, contact a qualified electrician. Do not attempt to modify the plug in any way.

DESCRIPTION

The terminology below will be used throughout the instructions.

- A** Glass knob
- B** Cover
- C** Handles
- D** Filter basket for coffee
- E** Urn body
- F** Pump tube
- G** Boiler
- H** Base
- I** Drip cup with drip tray
- J** Sliding tray for drip tray or cup
- K** Spout
- L** Dispensing Lever
- M** Water level indicator (number of cups)

Panel Type 1

- N** FRESHNESS indicator (time elapsed from when the coffee was prepared)
- O** READY light
- P** ON/OFF button
- Q** ON/OFF light
- R** Thermostat for "Keep Warm" function

Panel Type 2

- O** READY light
- P** ON/OFF button
- Q** ON/OFF light
- R** Thermostat for "Keep Warm" function

Panel Type 3

- N** FRESHNESS indicator (time elapsed from when the coffee was prepared)
- O** READY light
- P** ON/OFF button
- Q** ON/OFF light

SAFETY PRECAUTIONS

- This appliance is designed to make coffee and to heat beverages. Be careful not to burn yourself with sprays of hot water or by using the machine improperly.
- Do not touch hot surfaces.
- After removing the packaging, make sure that product is complete and in perfect condition. If in doubt, do not use the appliance and contact a qualified professional.
- This appliance is designed for commercial and household use. Any other use is considered improper and therefore dangerous.
- The manufacturer may not be held liable for any damage caused by improper, incorrect, or unreasonable use.
- Never touch the appliance with wet or damp hands or feet.
- Do not allow children or unfit persons to use the appliance unsupervised.
- Children must never be allowed to play with the appliance.
- In the event of failure or malfunction, switch the machine off and disconnect the power cord. For any repairs, contact an authorized service center only and ask for original spare parts. Failure to observe these safety precautions could jeopardize the safety of the appliance.
- The power cord on this appliance must not be replaced by the user, as this operation requires the use of special tools. If the cord is damaged or needs to be replaced, contact an authorized service center only.
- Always unplug the appliance from the outlet when it is not in use. Do not leave the appliance plugged in unnecessarily.
- Do not immerse the appliance in water.

INSTALLATION

- Place the appliance on a surface far away from water faucets and sinks.
- Check that the voltage of the electrical mains corresponds to the voltage shown on the appliance rating plate.

Connect the appliance only to an efficiently grounded power outlet with a minimum rating of 10 A. The manufacturer may not be considered liable for possible incidents caused by failure to adequately ground the outlet.

- Never install the appliance in a room where the temperature may reach 32°F/0°C or lower (the appliance may be damaged if the water freezes).
- Lift the cover by pressing down and turning counterclockwise. Remove the internal parts (filter basket and pump tube).

Wash the internal parts in warm water.

Do not immerse the appliance in water, but simply rinse the inside with water and wipe with a sponge and detergent if necessary. Rinse and dry thoroughly.

HOW TO MAKE COFFEE

- Place the appliance on the base without plugging into the outlet.
- Open the cover by pressing on the knob and turning counterclockwise until it releases from the handles.
- Fill with cold fresh water to the mark for the number of cups you want to make. Do not fill above the level of 50 or 60 cups (depending on model). Check the amount of water filled on the level indicator.

NEVER FILL BEYOND THE MAXIMUM LEVEL OF 50 OR 60 CUPS (DEPENDING ON MODEL)!

- Wet the filter basket (D – this keeps the ground coffee from sticking). Add coffee to filter basket using a standard tablespoon or a measuring cup. We recommend percolator or course ground coffee for best results. Table 1 shows the recommended amounts of coffee.
- Place the filter basket on the pump tube (F).
- Then place the tube-basket assembly inside the urn, making sure the pump tube is correctly positioned at the center of the boiler.
- Lock the cover into the urn. To do this correctly, press down on the cover and turn clockwise (fig. 1) until it hooks into the tabs of the handles.

CAUTION:
NEVER OPERATE THE APPLIANCE IF THE COVER IS NOT SECURELY FASTENED.

- Plug the power cord into the outlet; press the On/Off button (P) and the On/Off light (Q) will come on. The brewing begins within seconds.

You can see the coffee percolating action through the glass knob.

- When it stops and the green READY light (O) illuminates, the coffee is ready to serve using the dispensing lever (fig. 2).

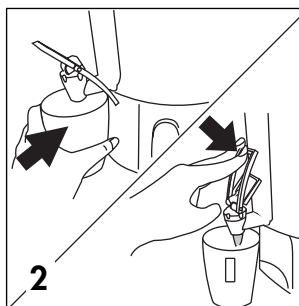
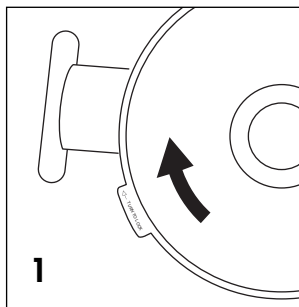

Keep Warm and Freshness Indicator Functions (Select Models Only)

When the coffee brewing cycle is completed and percolating stops, the coffee urn automatically switches to the KEEP WARM cycle.

On the models with a thermostat, select the keep warm

temperature by turning the knob to the desired position (fig. 3). Some models have a FRESHNESS indicator that shows how long it has been since the last coffee was brewed. When the coffee is just made, the light turns green, and every 20 minutes a triangle segment of the light becomes red.

When the entire light is red, this means that at least 1 hour has passed since the last preparation. The coffee is kept warm as long as the appliance is on.

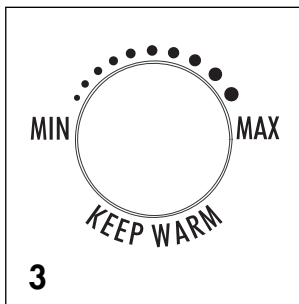

CARE AND CLEANING

If the water in your local area is hard, lime scale will form over time. These deposits may affect the correct operation of the appliance.

The coffee urn should be descaled every 50 cycles. To descale, use one of the commercially available scale removers for this type of appliance and follow the instructions on the package.

1. Wipe outside with a soft damp cloth only. Do not use solvents or abrasive detergents.
2. Wash the inside of the coffee urn with warm water and a mild detergent. Do not immerse the base or the body of the urn in water: it is an electrical appliance.
3. The cover, filter basket, and pump tube may be washed in the dishwasher. Make sure the bottom of the pump tube is clean. If necessary, hold it under running water or use a toothpick to remove any coffee grounds.
4. Store the coffee urn with the cover off.

TIPS

1. Before making coffee the first time, operate the coffee urn without using ground coffee to remove any dust residues from inside the appliance.
2. To reheat the coffee, remove the pump tube and filter basket, replace the cover and plug the unit in. The coffee will be hot in 20 to 60 minutes, depending on the amount of coffee left. Do not reheat if less than 20 cups are left in the coffee urn.

3. The appliance comes with a sliding tray for the drip tray or cup (fig. 4). This prevents coffee from dripping onto the floor or countertop.

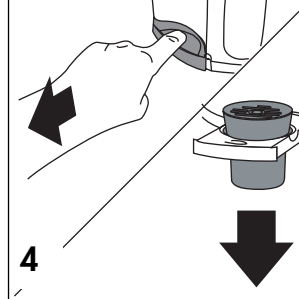

4. For the best results use percolator grind coffee, as it is coarser and will not pass through the basket. After making coffee a number of times you will know the right amount of coffee to use. As a starting point, see Table 1.

TABLE 1

CUPS	STANDARD MEASURE*
60	58-61
50	48-51
40	38-41
30	28-31
20	18-21
10	8-11

* 1 standard measure is equivalent to 1 heaping tablespoon.

The amounts given in the table are indicative only and can be adjusted according to personal taste and the type of coffee used.



This warranty applies to all products with De'Longhi or Kenwood brand names.

Limited Warranty

What does the warranty cover?

We warrant each appliance to be free from defects in material and workmanship. Our obligation under this warranty is limited to repair at our factory or authorized service center of any defective parts or part thereof, other than parts damaged in transit. In the event of a products replacement or return, the unit must be returned transportation prepaid. The repaired or new model will be returned at the company expense. This warranty shall apply only if the appliance is used in accordance with the factory directions, which accompany it, and on an Alternating current (AC) circuit.

How long does the coverage last?

This warranty runs for one year (1) from the purchase date found on your receipt and applies only to the original purchaser for use.

What is not covered by the warranty?

The warranty does not cover defects or damage of the appliance, which result from repairs or alterations to the appliance outside our factory or authorized service centers, nor shall it apply to any appliance, which has been subject to abuse, misuse, negligence or accidents. Also, consequential and incidental damage resulting from the use of this product or arising out of any breach of contract or breach of this warranty are not recoverable under this warranty. Some states do not allow the exclusion or limitation of incidental or consequential damage, so the above limitation may not apply to you.

How do you get service?

If repairs become necessary, see contact information below:

U.S. Residents:

Please contact our toll free hotline at 1-800-322-3848 or log onto our website at www.delonghi.com. For all accessories, spare parts or replacement parts, please contact our parts division at 1-800-865-6330.

Residents of Canada: Please contact our toll free hotline at 1-888-335-6644 or log onto our website at www.delonghi.com.

Residents of Mexico: Please refer to the Limited Warranty statement for Mexico (page 19). Please refer to the back page of the manual for De'Longhi addresses.

The above warranty is in lieu of all other express warranties and representations. All implied warranties are limited to the applicable warranty period set forth above. This limitation does not apply if you enter into an extended warranty with De'Longhi. Some states do not allow limitations on how long an implied warranty lasts, so the above exclusions may not apply to you. De'Longhi does not authorize any other person or company to assume for it any liability in connection with the sale or use of its appliance.

How does state law apply?

This warranty gives you specific legal rights, and you may also have other rights, which vary from state to state.