

This Owner's Manual is provided and hosted by [Appliance Factory Parts](#).



DE'LONGHI EMK6 Owner's Manual

[Shop genuine replacement parts for DE'LONGHI EMK6](#)



[Find Your DE'LONGHI Coffee Maker Parts - Select From 289 Models](#)

----- Manual continues below -----

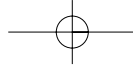

IMPORTANT INSTRUCTIONS
SAVE THESE INSTRUCTIONS

MODE D'EMPLOI IMPORTANT
CONSERVEZ LES PRESENTES INSTRUCTIONS

INSTRUCCIONES IMPORTANTES
GUARDE ESTAS INSTRUCCIONES

ISTRUZIONI IMPORTANTI
CONSERVARE LE ISTRUZIONI

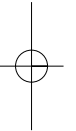
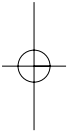
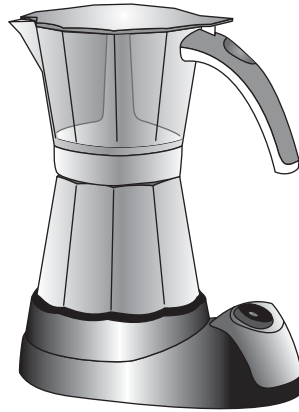

ELECTRIC MOKA COFFEE MAKER



CAFETERIE



CAFETERA



CAFFETTIERA

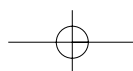

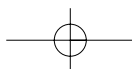
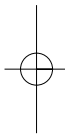
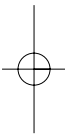
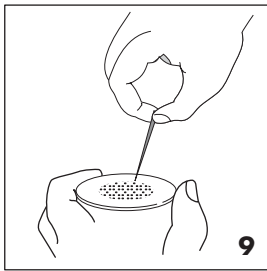
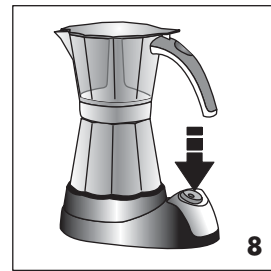
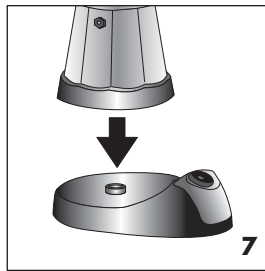
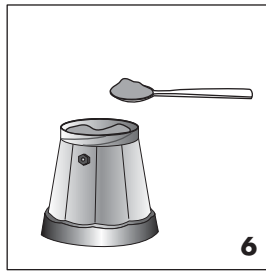
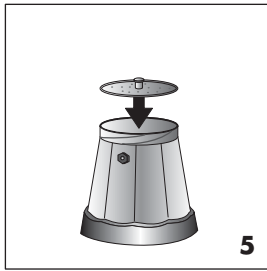
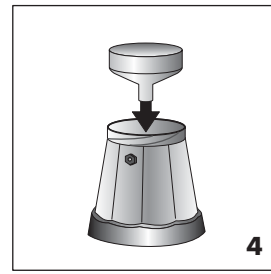
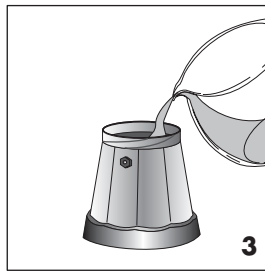
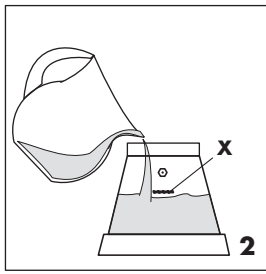
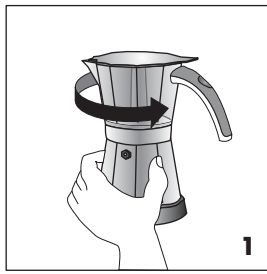
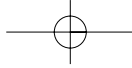

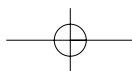
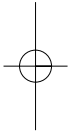
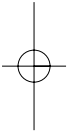
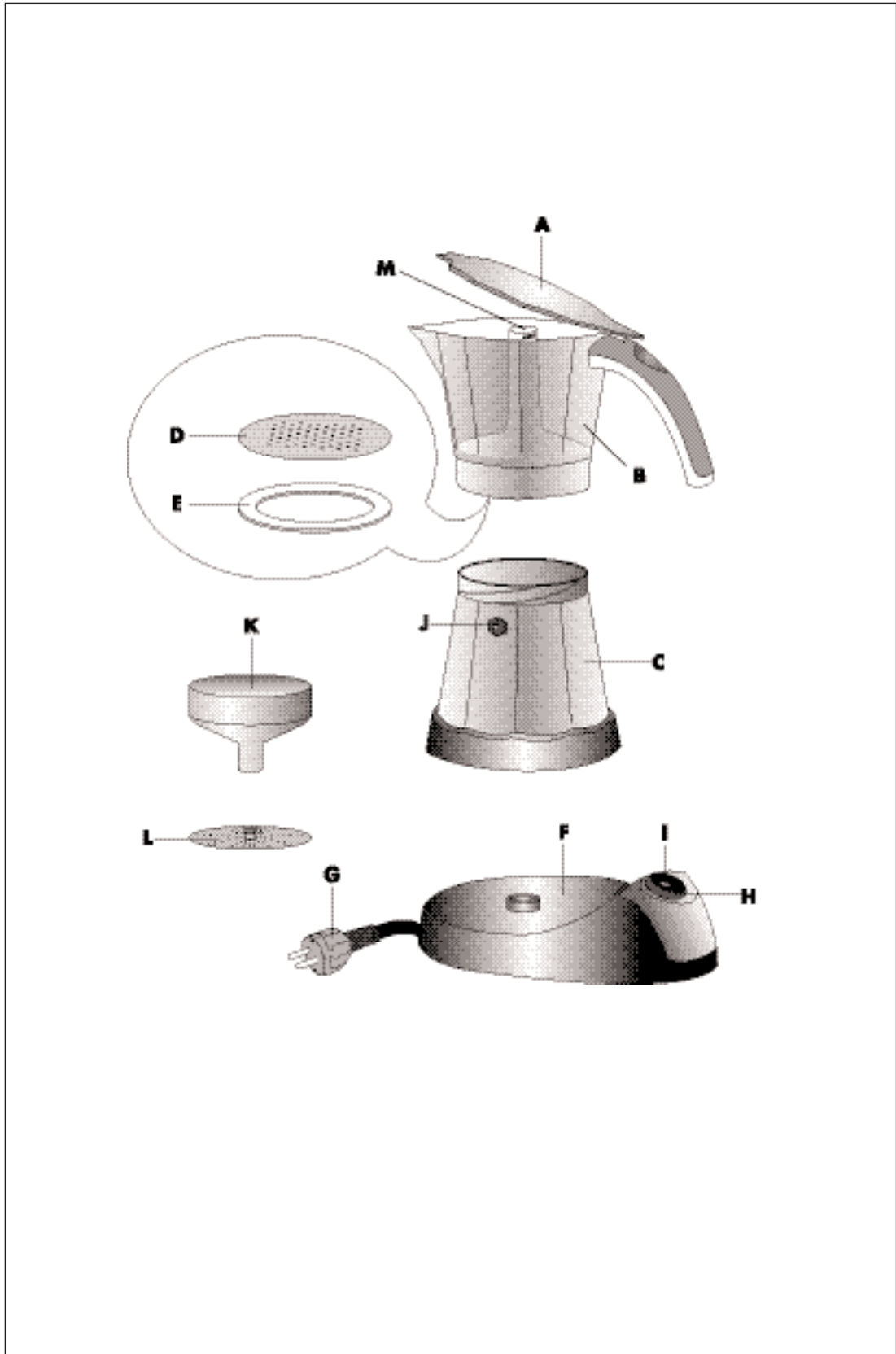
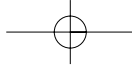



IMPORTANT SAFEGUARDS

When using electrical appliances, basic safety precautions should always be followed, including the following:

- Read all instructions.
- Do not touch hot surfaces. Use handles and knobs.
- To protect against fire, electrical shock and personal injury, do not immerse cord, plug or appliance in water or other liquid.
- Close supervision is necessary when any appliance is used by or near children.
- Unplug from the outlet when not in use and before cleaning. Allow to cool before fitting or taking off parts, and before cleaning the appliance.
- Do not operate with a damaged cord or plug, or after the appliance malfunctions, or has been damaged in any manner. Return the appliance to the nearest authorized service facility for examination, repair or adjustment.
- The use of accessory attachments or spare parts not recommended by the appliance manufacturer may result in fire, electrical shock or personal injury.
- Do not use outdoors.
- Do not let the cord hang over the edge of the table or counter, or touch hot surfaces.
- Do not place on or near a hot gas or electrical burner, or in a heated oven.
- To disconnect the appliance, turn any control to "off", then remove plug from wall outlet.
- Do not use the appliance for other than the intended use.
- This appliance is for household use only.

SAVE THESE INSTRUCTIONS

SHORT CORD INSTRUCTIONS

- A short power cord is provided to reduce risks resulting from becoming entangled in or tripping over a longer cord.
- Longer, detachable power supply cords or extension cords are available and may be used if care is exercised in their use.
- If an extension cord is used, the marked electrical rating should be at least as great as the electrical rating of the appliance. The longer cord should be arranged so that it will not drape over the counter-top or table top where it can be pulled on by children or tripped over.
- Your product is equipped with a polarized alternating current line plug (a plug having one blade wider than the other). This plug will fit into the power outlet only one way. This is a safety feature. If you are unable to insert the plug fully into the outlet, try reversing the plug. If the plug should still fail to fit, contact your electrician to replace your obsolete outlet. Do not defeat the safety purpose of the polarized plug.

Carefully read this instruction booklet before installing and using the appliance. This is the only way to ensure the best results and maximum safety for the user.

DESCRIPTION OF THE APPLIANCE

The following terminology will be used repeatedly on the following pages

- A. Container Lid
- B. Container
- C. Boiler
- D. Disk filter
- E. Gasket
- F. Base
- G. Power Cord
- H. On/off switch
- I. Power Light
- J. Safety valve
- K. Filter
- L. Half pot adapter disk
- M. Tube

SAFETY WARNINGS

- This machine has been manufactured to “make coffee”. Never use other extracts, cocoa powder, camomile, other infusions or soluble substances: these may block the holes in the filter.
- **During cleaning, never immerse the base and the boiler in water: this is an electrical appliance.**
- Be careful to avoid being scalded by spraying water or steam or due to the improper use of the appliance.
- When using the appliance do not touch the hot surfaces. Use the buttons or handles.
- After having removed the packaging, check that the appliance is in tact. If in doubt, do not use the appliance and contact a professionally qualified person.
- The parts of the packaging (plastic bags, polystyrene foam, etc.) must not be left within the reach of children, as they are potential sources of danger.
- This appliance must only be used for household purposes. All other uses are considered improper and as a result dangerous.

- The manufacturer declines all liability for any damage deriving from improper, erroneous and unreasonable use of the appliance.
 - The appliance must work only connected to a power outlet; never use directly on stovetop burner
 - Never touch the appliance with wet or damp hands.
 - Never allow the appliance to be used without supervision by children.
 - Make sure that children do not play with the appliance.
 - In the event of faults or malfunctioning of the appliance, switch it off and do not tamper with it
- For any repairs, contact an authorized DeLonghi Service Center and insist on the use original spare parts. Failure to observe the above warnings may compromise the safety of the appliance.

- The power cord for this appliance must not be replaced by the user, in that this operation requires the use of special tools. In the event of damage, only contact a service centre authorised by the manufacturer so as to avoid any risks.
- Fill the boiler with water before placing the Moka coffee maker on the support base.
- Do not let the power cord come into contact with the metallic parts of the Moka coffee maker when in operation.

INSTALLATION

- Place the appliance on a stable surface away from water taps and sinks.
- Check that the voltage of the outlet corresponds to the value indicated on the appliance’s rating plate. Only connect the appliance to a power outlet with a minimum rating of 6A that is properly grounded. The manufacturer declines all liability for any accidents caused if the system is not correctly grounded.
- If the power outlet does not match the plug on the appliance, have the outlet replaced with a suitable type by qualified DeLonghi service technician.

HOW TO PREPARE THE COFFEE

1) Check that the coffee maker is cold, and then unscrew it by holding the boiler with one hand and turning the container counter-clockwise with the other (Fig. 1).

2) Remove the filter and, to prepare a full pot of coffee, fill the boiler with fresh water until reaching the safety valve (visible inside the boiler), without exceeding it (Fig. 2).

To prepare half a pot of coffee maker, fill the boiler with water to the circular mark under the safety valve (Fig. 3 - X).

TIP: use fresh and soft water. Salty or hard water will weaken the flavor.

IMPORTANT: Do not use the coffee maker without water in the boiler or alternatively using hot water for faster operation.

3) Insert the filter in the boiler (Fig. 4). When preparing half a pot, also place the adapter disk (L) into the funnel filter (Fig. 5).

4) Fill the filter with ground coffee, without tamping it (Fig. 6). Fill it a little at a time to prevent spilling the ground coffee.

5) Distribute the ground coffee uniformly and remove any excess coffee from the edge of the filter.

IMPORTANT: Use good quality, medium-ground coffee, for Moka coffee makers.

6) Tighten the coffee maker securely. Hold the boiler with one hand and turn the container clockwise with the other without pushing on the handle.

7) Rest the coffee maker on the base (Fig. 7). Close the lid.

8) Press the on/off switch (Fig. 8).

The power light indicates that the coffee maker is on.

9) The coffee will start to be released after a few minutes.

10) When the pitcher is full, mix the coffee for uniformity before serving it.

IMPORTANT: The first time that the coffee maker is used, all the accessories should be washed with hot water. Then make a few batches of coffee to throw away.

KEEP-WARM FUNCTION

Using the keep warm device, the coffee can be at the right temperature up to half an hour after starting the machine.

This device is automatically disabled when the coffee maker is removed from the base after the coffee has brewed.

If the coffee maker is rested on the base with coffee still in the container, it can be kept warm for another half an hour by pressing the on/off switch.

In any case, once the coffee has brewed, the coffee maker can be switched off by pressing the on/off switch.

CLEANING AND MAINTENANCE

- Before performing the cleaning operations, wait for the coffee maker to have cooled down after use.
- Clean the inside of the tube periodically.
- Regularly check the filter and the gasket: replace if there are signs of wear or deterioration. Use original spare parts only.
- Every so often check that the holes in the disk filter are not blocked; if necessary, clean using a pin (Fig. 9).
- Do not wash the coffee maker in the dishwasher.
- When cleaning do not use solvents or abrasive detergents. Simply clean it with a sponge, keeping attention not to wet the electrical parts.

Never rinse the boiler under the tap water and never immerse it in water.



TROUBLESHOOTING

PROBLEM	CAUSE	SOLUTION
No coffee is released	No water in the boiler	Fill the boiler with fresh water
The coffee takes a long time to be released	The coffee used is not the right type The disk filter is blocked The coffee has been tamped	Use ground coffee expressly for Moka coffee makers Clean the disk filter as described in the paragraph "Cleaning and maintenance" Do not tamp the ground coffee
Coffee leaks from the edges of the boiler	The disk filter is blocked The gasket is burned or torn	Clean the disk filter as described in the paragraph "Cleaning and maintenance" Replace the gasket.