

This Owner's Manual is provided and hosted by [Appliance Factory Parts](#).



# Coleman 5040B740 Owner's Manual

[Shop genuine replacement parts for Coleman  
5040B740](#)



[Find Your Coleman Camping Parts - Select From 855 Models](#)

----- Manual continues below -----



# Patio Heater & Light

Model 5040B740  
Model 5040B750

## INSTRUCTIONS FOR USE

Patent # 6,422,232  
Patent # 6,499,480  
Patent # US D451,988 S

© 2003 The Coleman Company, Inc.  
[www.coleman.com](http://www.coleman.com)

### IMPORTANT

Read this manual carefully before assembling, using or servicing this heater. Keep this manual for future reference. If you have questions about assembly, operation, servicing or repair of this heater, please call Coleman at 1-800-835-3278 or TDD: 316-832-8707.  
In Canada call 1-800-387-6161.



1AS 9-96 & CSA International  
Requirement 5.90 U.S.



## Contents

General Safety Information  
Assembly  
Leak Check  
Mantles  
Operation  
Shut Down Procedure  
Storage  
Maintenance  
Troubleshooting  
Service  
Warranty  
Parts List

## General Safety Information

This manual contains important information about the assembly, operation and maintenance of this portable heater. General safety information is presented in these first few pages and is also located throughout the manual. Particular attention should be paid to information accompanied by the safety alert symbols: "▲ DANGER", "▲ WARNING", "▲ CAUTION".

Keep this manual for future reference and to educate new users of this product. This manual should be read in conjunction with the labeling on the product.

Safety precautions are essential when any mechanical or propane fueled equipment is involved. These precautions are necessary when using, storing, and servicing. Using this equipment with the respect and caution demanded will reduce the possibilities of personal injury or property damage.

The following symbols shown below are used extensively throughout this manual. Always heed these precautions, as they are essential when using any mechanical or fueled equipment.

### ▲ DANGER

DANGER indicates an imminently hazardous situation which, if not avoided, will result in death or serious injury.

### ▲ WARNING

WARNING indicates a potentially hazardous situation which, if not avoided, could result in death or serious injury.

### ▲ CAUTION

CAUTION indicates a potentially hazardous situation which, if not avoided, may result in minor or moderate personal injury, or property damage

## FOR YOUR SAFETY

If you smell gas:

1. Shut off gas to the appliance.
2. Extinguish open flame.
3. If odor continues, immediately call your gas supplier.

## General Safety Information *continued.*

### FOR YOUR SAFETY

Do not store or use gasoline or other flammable vapor and liquids in the vicinity of this or any other appliance.

▲ **WARNING: For Outdoor Use Only**

### ▲ WARNING

Improper installation, adjustment, alteration, service or maintenance can cause injury or property damage. Read the instructions thoroughly before installing or servicing this equipment

### ▲ DANGER

Failure to comply with the precautions and instructions provided with this heater can result in death, serious bodily injury and property loss or damage from hazards of fire, explosion, burn, asphyxiation, and/or carbon monoxide poisoning.

Only persons who can understand and follow the instructions should use or service this heater.

If you need assistance or heater information such as an instruction manual or labels, contact the Coleman Co., Inc.

### ▲ DANGER



#### • EXPLOSION - FIRE HAZARD

- Keep solid combustibles, such as building materials, paper or cardboard, a safe distance away from the heater as recommended by the instructions.
- Provide adequate clearances around air openings into the combustion chamber.
- Never use the heater in spaces which do or may contain volatile or airborne combustibles, or products such as gasoline, solvents, paint thinner, dust particles or unknown chemicals.
- During operation, this product can be a source of ignition. Keep heater area clear and free from combustible materials, gasoline, paint thinner, cleaning solvents and other flammable vapors and liquids. Do not use heater in areas with high dust content. Minimum heater clearances from combustible materials: three (3) feet from the sides & two (2) feet from the top.

### ▲ WARNING

We cannot foresee every use which may be made of our heaters. **Check with your local fire safety authority if you have questions about heater use.**

Other standards govern the use of fuel gases and heat producing products for specific uses. Your local authorities can advise you about these.

If no local codes exist, follow National Fuel Gas Code, ANSI Z223.1. In Canada, installation must conform to local codes. If no local codes exist, follow the current National standards of CANADA CAN/CGA-B 149.2.

**⚠ DANGER**



• **CARBON MONOXIDE HAZARD**

- This heater is a combustion appliance. All combustion appliances produce carbon monoxide (CO) during the combustion process. This product is designed to produce extremely minute, non-hazardous amounts of CO if used and maintained in accordance with all warnings and instructions. Do not block air flow into or out of the heater.
- Carbon Monoxide (CO) poisoning produces flu-like symptoms, watery eyes, headaches, dizziness, fatigue and possibly death. You can't see it and you can't smell it. It's an invisible killer. If these symptoms are present during operation of this product **get fresh air immediately!**
- **For outdoor use only.**
- **Never use inside house, or other unventilated or enclosed areas. This heater consumes air (oxygen). Do not use in unventilated or enclosed areas to avoid endangering your life.**

**⚠ WARNING**

- This product is fueled by propane gas. Propane gas is invisible, odorless, and flammable. An odorant is normally added to help detect leaks and can be described as a "rotten egg" smell. The odorant can fade over time so leaking gas is not always detectable by smell alone.
- Propane gas is heavier than air and leaking propane will sink to the lowest level possible. It can ignite by ignition sources including matches, lighters, sparks or open flames of any kind many feet away from the original leak. Use only propane gas set up for vapor withdraw.
- Propane gas should be stored or used in compliance with local ordinances and codes or with ANSI/NFPA 58. Turn off propane when not in use.

**CALIFORNIA PROPOSITION 65:**

WARNING: Propane and by-products of combustion of propane contain chemicals known to the state of California to cause cancer, birth defects, or other reproductive harm.

**Assembly**

- Remove all components from package.

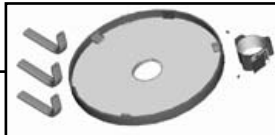
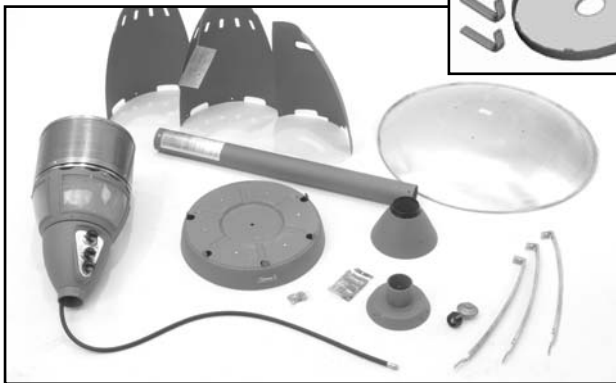







Table not included on all models.

- 

**3 Req'd Hex Nut**
- 

**3 Req'd Washers**
- 

**3 Req'd Acorn Nuts**
- 

**15 Req'd Large Screw**
- 

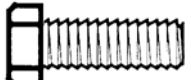
**6 Req'd Small Screw**
- 

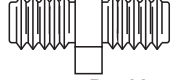
**4 Req'd Hex Head Screw**
- 

**3 Req'd Reflector Bolt**

**⚠ DANGER**



• **EXPLOSION - FIRE HAZARD**

- Never store propane near high heat, open flames, pilot lights, direct sunlight, other ignition sources or where temperatures exceed 120 degrees F (49°C).
- Propane is heavier than air and can accumulate in low places. If you smell gas, leave the area immediately.
- Never install or remove propane tank while heater is lighted, near flame, pilot lights, other ignition sources or while heater is hot to touch.
- This heater is red hot during use and can ignite flammables too close to the burner. Keep flammables at least 3 feet from sides & 2 feet from top. Keep gasoline and other flammable liquids and vapors well away from heater.
- The propane tank must always be stored outdoors in a well ventilated space. Never store propane tank in an enclosed area (house, garage, etc.). If heater is to be stored indoors, disconnect the propane tank for outdoor storage.

**⚠ WARNING**



• **BURN HAZARD**

- Never leave heater unattended when hot or in use.
- Keep out of reach of children.

**⚠ CAUTION**

• **SERVICE SAFETY**

- Keep all connections and fittings clean. Make sure propane tank valve outlet is clean.
- Inspect hose before use. Replace if there is evidence of abrasion or wear.
- During set up, check all connections and fittings for leaks using soapy water. Never use a flame.
- Use as a heating appliance only. Never alter in any way or use with any device or part not expressly approved by Coleman.
- Check entire hose at least annually.

**Tools Required**

Phillips screwdriver and 7/16" open-end wrench

**Step 1**

- Align 2 Cylinder Cover Pieces. Place left piece over right piece as shown.

- Align holes in Post Base with holes in Cylinder Cover Pieces.



## Step 1 (continued)

■ Attach Post Base to Cylinder Cover Pieces loosely with seven Large Screws.



7 Required  
Large Screw

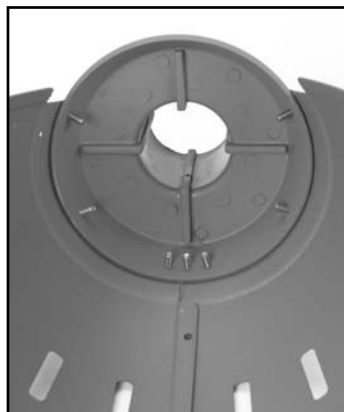
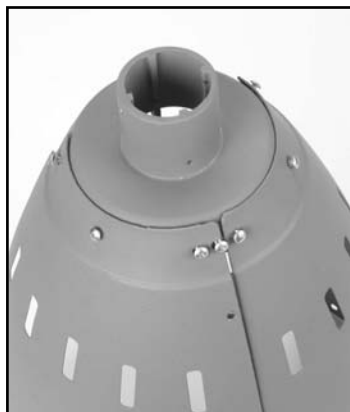

## Step 2

■ Identify Center Rear Support Bracket. It has six holes, various sizes.

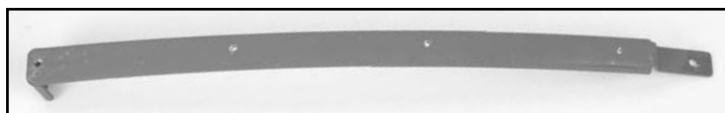

■ Place Center Rear Support Bracket in place over the center screw.

■ Assemble one nut loosely over the screw to attach the Center Rear Support Bracket.



1 Req'd  
Hex Nut

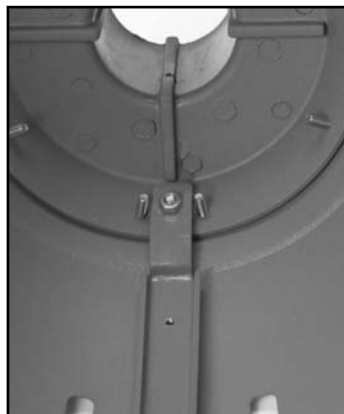
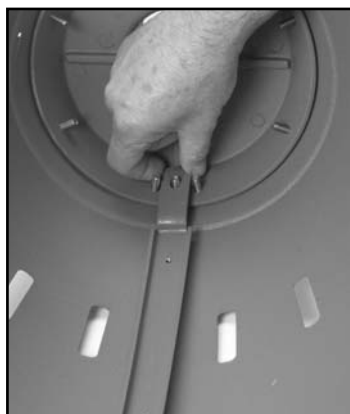

## Step 2 (continued)

■ Turn unit over and assemble large screw loosely through Cover Pieces into base of Center Rear Support Bracket.



1 Required  
Large Screw



■ Assemble three small screws loosely through Cover Pieces into base of Center Rear Support Bracket.



3 Req'd  
Small Screw

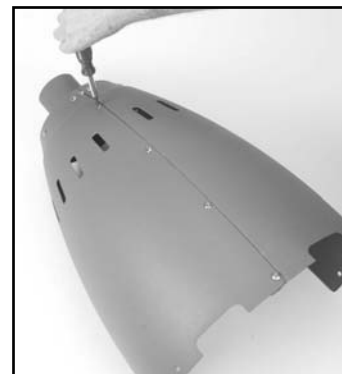

## Step 3



1 Req'd  
Hex Nut



1 Required  
Large Screw

■ Attach a Side Support Bracket loosely with Hex Nut at top.

■ Attach one large screw loosely at base of Side Support Bracket.

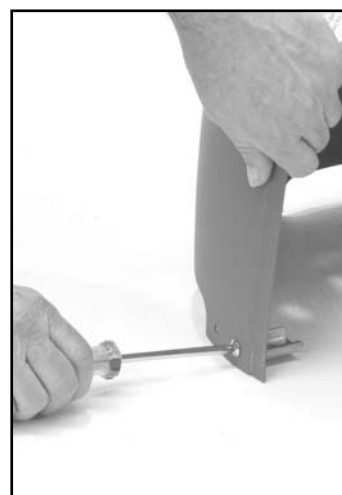
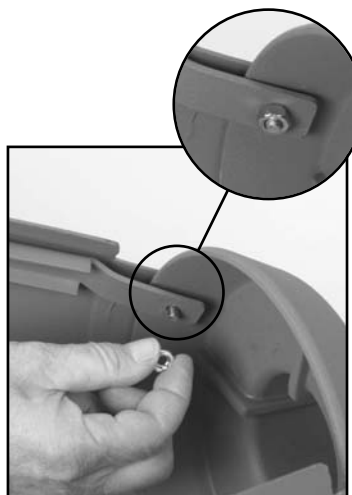

**Step 3** *(continued)*

■ Attach the second Side Support Bracket loosely with Hex Nut at top.

■ Attach one large screw loosely at base of the second Side Support Bracket.

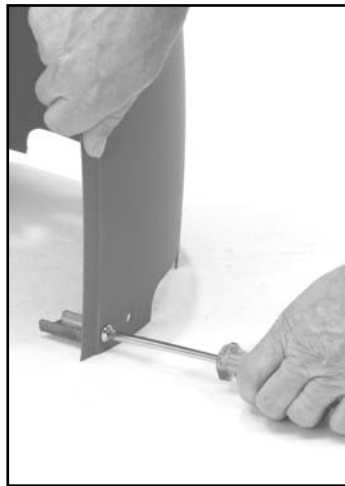
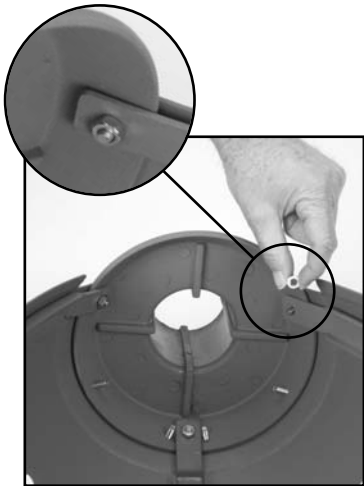

**Step 4**

■ Set cylinder cover assembly on top of heater base. Position opening opposite the wheels.



**Step 4** *(continued)*

■ Attach Cylinder Cover Pieces to Base with two large screws horizontally into the Base Tabs.



■ Attach three Support Brackets to Base with three large screws downward through Support Brackets into the Base.

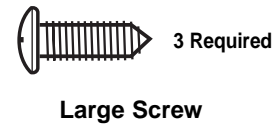

**Step 5**

■ Tighten all fasteners. Use a #2 Phillips screwdriver to tighten all screws. Use a 7/16" open end wrench to tighten all hex nuts.

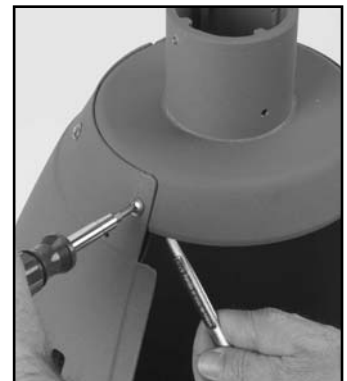

### Step 6

- Install post onto post base.
- Decal on post should face front of heater (see photo on front cover).
- Attach post to post base using four large screws.
- Tighten screws securely.

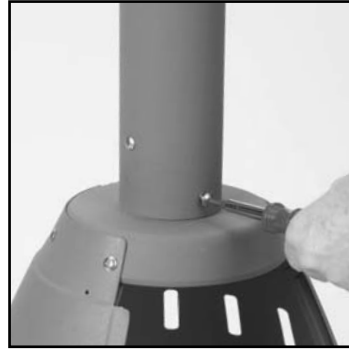
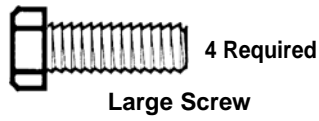
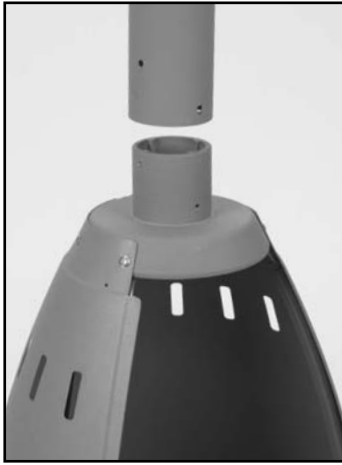

### Step 7

- Load cover onto post.
- Slide cover down.



(For models without a table, skip to Step 12)

### Step 8

- Insert table supports into the receptors located in the underside of the table frame.

**NOTE:** Screws must be backed out of the support tubes. Use those screws to attach the clamp in the next step.

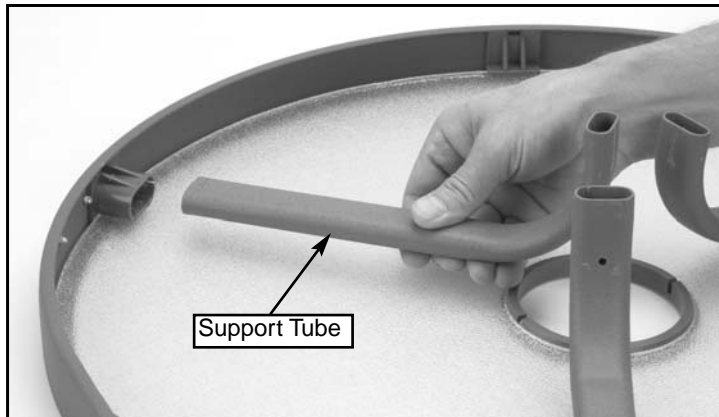

### Step 9

- Using the three screws removed in Step 8, securely attach clamp assembly to support tubes.

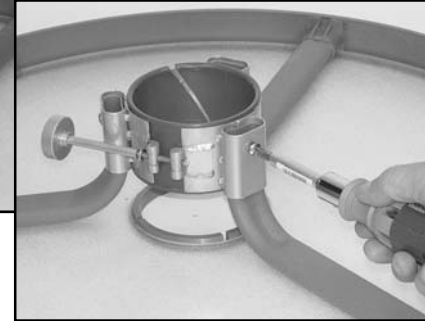
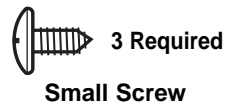
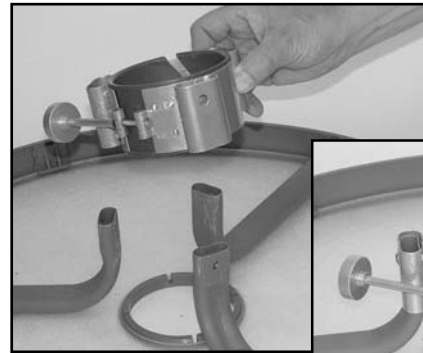

### Step 10

- Load table onto post by sliding table clamp over post and feed post through center hole of table.
- Slide table to desired position.



### Step 11

- Tighten clamp so table is secured to the post.

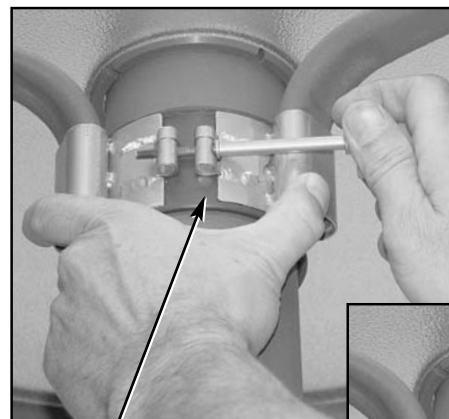

Friction Sleeve (between clamp and post)  
Gap in Sleeve should be opposite gap in clamp

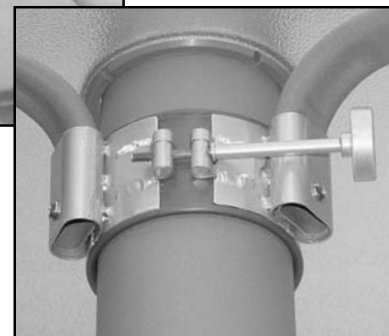

**Step 12**

- Insert studs into screen cover.

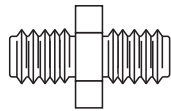

**3 Req'd Brass Reflector Studs**



**Step 13**

- Load head assembly by inserting hose into post.



- Insert head assembly into post.
- Control knob should be above decal on post.

- Attach head assembly to post, and loosely install three screws.
- Tighten screws securely.



**3 Required Small Screw**

**Step 14**

- Support Heater.
- Locate assembled reflector on 3 studs (ref. Step 12).
- Install washers on studs & securely tighten acorn nuts but do not over-tighten! Use a 7/16" nut driver or open-end wrench.



**3 Req'd Acorn Nut**



**3 Req'd Washers**



**Step 15**

- You must provide propane gas and propane tank. Use a standard 20 lb. propane tank only.
- Use this heater only with a propane vapor withdrawal supply system. See Chapter 5 of the *Standard for Storage and Handling of Liquefied Petroleum Gas, ANSI/NFPA 58*. Your local library or fire department will have this book.
- A minimum supply pressure of 11.0 W.C. is required for the purpose of input adjustment for propane gas.
- The pressure regulator and hose assembly supplied with the appliance must be used.
- The installation must conform with local codes, or in the absence of local codes, with National Fuel Gas Code, ANSI Z223.1.
- A dented, rusted or damaged propane tank may be hazardous and should be checked by your tank supplier. Never use a propane tank with a damaged valve connection.
- The propane tank must be constructed and marked in accordance with the specifications for LP gas cylinders of the U.S. Department of Transportation (DOT).
- Never connect an unregulated propane tank to the heater.



Standard 20 lb. tank

**Step 15 (continued)**

■ Screw regulator onto hose. Do not cross-thread.



■ Attach regulator to tank.



■ Complete attachment.



■ Install tank.

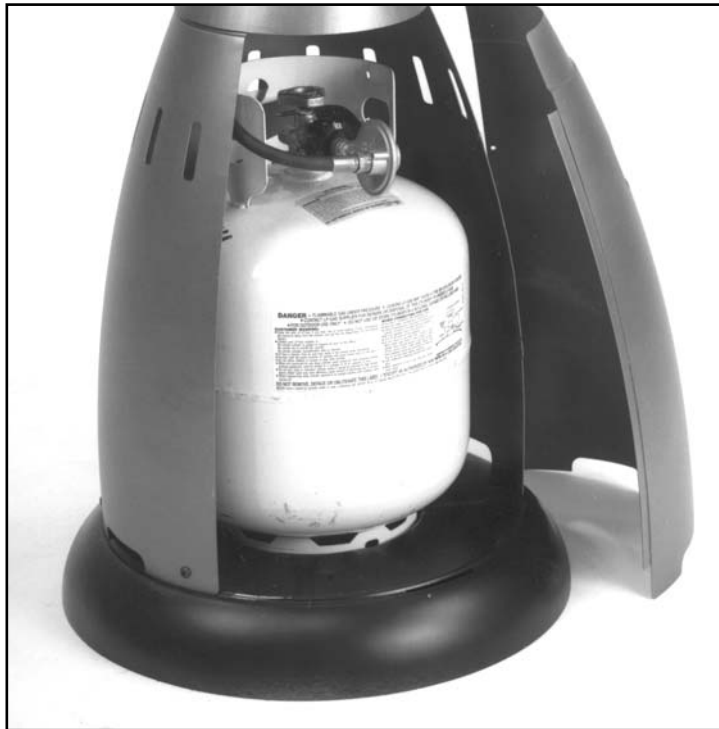

■ Tighten Securely.



■ Install tank.



## Leak Check

### ⚠ WARNING

- Perform all leak tests outdoors.
- Extinguish all open flames.
- NEVER leak test when smoking.
- Do not use the heater until all connections have been leak tested and do not leak.

#### Hose/Regulator Connection



#### Regulator/Cylinder Connection



- Make 2-3 oz. of leak check solution (one part liquid dishwashing detergent and three parts water).
- Apply several drops of solution where hose attaches to regulator.
- Apply several drops of solution where regulator connects to Cylinder.
- Make sure all Patio Heater & Light valves are OFF.
- Turn Cylinder Valve ON.

**If bubbles appear at any connection, there is a leak.**

- Turn Cylinder Valve OFF.
- If leak is at Hose/Regulator connection: tighten connection and perform another leak test. If you continue to see bubbles after several attempts, contact 1-800-835-3278 for assistance.
- If leak is at Regulator/Cylinder Valve connection: disconnect, reconnect, and perform another leak check. If you continue to see bubbles after several attempts, cylinder valve is defective and should be returned to cylinder's place of purchase.

**If NO bubbles appear at any connection, the connections are secure.**

- Turn Cylinder Valve OFF.

**NOTE: Whenever gas connections are loosened or removed, you must perform a complete leak test.**

- Lift cover while installing remaining cylinder cover section.

- Complete installation.



## Mantles

- Remove 2 glass panels.



- Slip mantle onto burners. Align clips in mantle with groove in burner. Be sure clip points away from electrode.

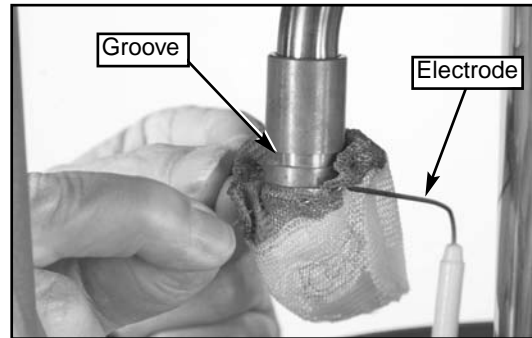

- Twist clips.

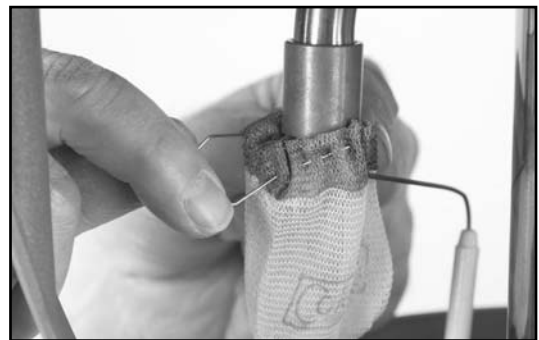

## Mantles *continued.*

- Attach second mantle. Illustration below shows proper assembly of both mantles.

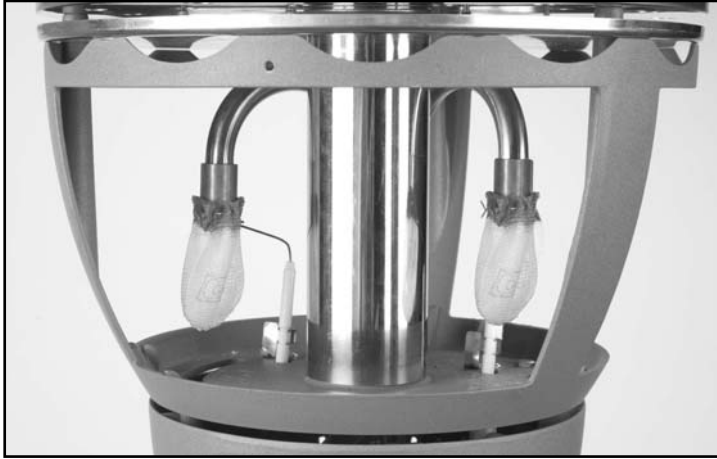

- Light bottom of mantles evenly. Burn until nothing but white ash remains. Once mantle has been burned it's very fragile. Be careful not to touch it with a finger or match. Install glass panels.



## Battery Installation for HEATER

- Unscrew igniter button to reveal battery compartment.
- Install AA battery with positive (+) outward.
- Replace igniter button finger tight.



## Operation

### **! DANGER**



#### • CARBON MONOXIDE HAZARD

- For outdoor use only. Never use inside house, or other unventilated or enclosed areas. This heater consumes air (oxygen). Do not use in unventilated or enclosed areas to avoid endangering your life.

### **! DANGER**



#### • EXPLOSION - FIRE HAZARD

- Never store propane near high heat, open flames, pilot lights, direct sunlight, other ignition sources or where temperatures exceed 120 degrees F (49°C).
- Propane is heavier than air and can accumulate in low places. If you smell gas, leave the area immediately.
- Never install or remove propane tank while heater is lighted, near flame, pilot lights, other ignition sources or while heater is hot to touch.
- This heater is red hot during use and can ignite flammables too close to the burner. Keep flammables at least 3 feet from sides & 2 feet from top. Keep gasoline and other flammable liquids and vapors well away from heater.
- The propane tank must always be stored outdoors in a well ventilated space. Never store propane tank in an enclosed area (house, garage, etc.). If heater is to be stored indoors, disconnect the propane tank for outdoor storage.

- Do not attempt to operate until you have read & understand all General Safety Information in this manual and all assembly is complete & leak checks have been performed.

## Lighting Instructions for HEATER

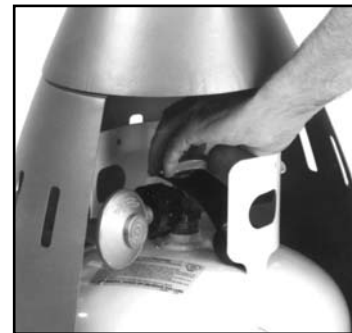

- Turn cylinder valve on.

1. Push in and rotate (counter clockwise) heater control knob to the Pilot position and release.
2. Push in on heater control knob and push Igniter Button to ignite Pilot Light.

**Note:** Initial lighting after gas cylinder change can take up to two (2) minutes to purge any air that may be in the line.

**Lighting Instructions for HEATER** *continued.*

3. Pilot Light will ignite and be visible through Pilot Viewing Port (flame may be difficult to see in broad daylight). Continue to push Heater Control Knob in for 30 to 60 seconds after pilot is on, then release knob. Pilot Light must remain on, if not return to step 1.



**Note:** If pilot fails to remain lighted, all valves should be closed and a waiting period of at least 5 minutes should pass before attempting to light.

4. Rotate Heater Control Knob to ON position. Heater burner will light and be visible through screen of heater. If Main burner does not light, turn off Heater Control Knob and return to Step 1.

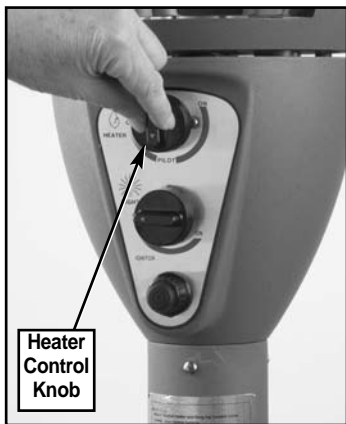

**Lighting Instructions for LIGHT**

1. Push in and rotate Light Control Knob to the ON position while pushing the Igniter Button until BOTH mantles are lighted.

**Note:** If BOTH mantles are not lighted within 5 seconds, turn Light Control Knob to OFF position. All controls should be turned to the OFF position and a period of at least 5 minutes should pass before reattempting to light burners.

2. Mantles will light and begin to glow which can be seen through the windows. If the mantles do not light or fail to remain lighted turn OFF Light Control Knob and return to Step 1.

■ Unit can be operated with heater & light both operating or either operating separately.



**Match Lighting Instructions for HEATER**

1. Turn cylinder valve on.

2. Push in and rotate (counter clockwise) Heater Control Knob to the Pilot position and release.



3. Use a long match. Locate Pilot Port directly above center glass panel.
4. Light a long fireplace match (minimum 4" long) and insert into Pilot Port, then push in and hold Heater Control Knob.
5. Pilot light will ignite and be visible from Pilot Port or Pilot Viewing Port. Continue to push Heater Control Knob in for 30 to 60 seconds after pilot is on, then release knob. Pilot light must remain on, if not return to Step 1.

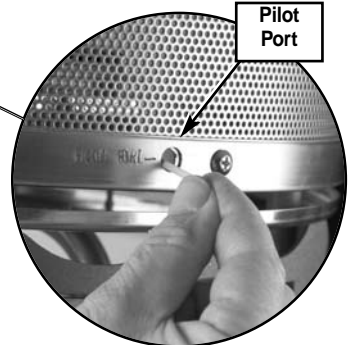

**Note:** If pilot fails to remain lighted, all valves should be closed and a waiting period of at least 5 minutes should pass before attempting to light.

6. Rotate Heater Control Knob to ON position. Heater burner will light and be visible through screen of heater. If Heater burner does not light, turn off Heater Control Knob and return to Step 1.

### Match Lighting Instructions for LIGHT

1. Turn cylinder valve on.
2. Remove front glass.



3. Place a lighted match near mantle, then push in and rotate Light Control Knob to the ON position. Immediately light second mantle with match.



**Note:** If BOTH mantles are not lighted within 5 seconds, turn Light control knob to OFF position. All controls should be turned to the OFF position and a period of at least 5 minutes should pass before reattempting to light mantles.

4. Carefully replace front glass.

### Shut Down Procedure

#### HEATER

1. Rotate Heater control knob (clockwise) to pilot position.
2. Push in on Heater control knob and rotate (clockwise) to OFF position.

#### LIGHT

1. Push in and rotate Light control knob (clockwise) to OFF position.

*The gas supply must be turned off at the LP-gas cylinder when this appliance is not in use.*

### Storage

**Disconnect heater from propane tank before long term storage of either the cylinder or the Heater.**

1. Turn cylinder valve off.
2. Disconnect regulator from cylinder.
3. Remove tank from Heater.
4. Store propane tank in safe manner. Refer to Chapter 5 of *Standard for Storage and Handling of Liquefied Gases, ANSI/NFPA 58*. Follow all local codes. Always store propane tanks outdoors.
5. Store heater in a dry, clean, and safe place.

### **WARNING**



#### • BURN HAZARD

- Do not touch or attempt any maintenance on Heater for at least 1 hour after use.
- Make sure all controls are off and propane tank has been removed before doing maintenance.

### Maintenance

To enjoy years of outstanding performance from your Heater perform the following maintenance activities on a regular basis:

- Keep exterior surfaces clean.
- Use warm soapy water for cleaning. Never use flammable or corrosive cleaning agents. For stainless steel surfaces, use a stainless steel cleaner available at most retail stores.
- While cleaning your unit, be sure to keep the area around the burner, pilot assembly and mantle area dry at all times. If the regulator is exposed to water in any way, do NOT try to use it. It must be replaced.
- Air flow must be unobstructed. Keep controls, burner, and circulating air passages clean. Signs of possible blockage include:
  - Gas odor with extreme yellow tipping of flame.
  - Heater does NOT reach the desired temperature.
  - Heater glow is excessively uneven.
  - Heater makes popping noises.
  - Light is uneven or burns with a yellow smokey flame.
- Spiders and insects can nest in burner orifices. This condition can damage heater and render it unsafe for use. Clean burner holes by using a heavy-duty pipe cleaner. Compressed air may help clear away small particles.
- Carbon deposits may create a fire hazard. Clean light and burner with warm soapy water if any carbon deposits develop.
- NOTE: In a salt-air environment (such as near an ocean), corrosion occurs more quickly than normal. Frequently check for corroded areas and repair them promptly.

## Troubleshooting

Problem	Possible Cause	Solution
<b>Pilot won't light</b>	Cylinder valve is closed	Open valve
	Blockage in orifice or pilot tube	Clean or replace orifice or pilot tube
	Air in gas line	Pilot may take 1-2 minutes to light after a propane bottle has been connected
	Low gas pressure with Cylinder Valve fully open	Cylinder is empty. Replace cylinder
	Igniter fails	Use match to light pilot. Obtain new igniter and replace
	Heater control knob <b>not</b> fully depressed in pilot position when lighting pilot	Depress heater control knob firmly in light position when lighting pilot
	No spark at burner electrode	Use match to light pilot. If wire to electrode is damaged - replace with new wire and/or carbon across spark gap
<b>Pilot won't stay lit</b>	Dirt built up around pilot	Clean dirt from around pilot
	Connection between gas valve and pilot assembly is loose	Tighten connection and perform leak check
	Thermocouple is not operating correctly	Tighten all thermocouple connections. Replace if faulty
<b>Burner won't light</b>	Gas pressure is low	Turn Cylinder valve OFF and replace cylinder
	Blockage in orifice	Clear blockage
	Control knob is not in ON position	Turn control knob to ON
<b>Light won't light</b>	Gas pressure is low	Turn Cylinder valve OFF and replace cylinder
	Blockage in orifice	Clear blockage
	Control knob is not in ON position	Turn control knob to ON
	Igniter fails	Use match to light pilot. Obtain new igniter and replace
<b>Burner flame is low</b>  NOTE: Do not operate heater below 0° F.	Gas pressure is low	Turn Cylinder valve OFF and replace cylinder
	Outdoor temperature is less than 40° F and tank is less than 1/4 full	Use a full cylinder
	Supply hose is bent or kinked	Straighten hose
	Control knob fully ON	Check burner and orifices for blockage
<b>Carbon build-up</b>	Dirt or film on reflector and burner screen	Remove blockage from burner screen holes and clean burner screen inside and outside
<b>Thick black smoke from burner or light</b>	Blockage in burner or in light gas passages	Remove blockage and clean burner inside and outside
<b>Mantles light but dim out when heater is turned on.</b>	Faulty Regulator (First insure cylinder valve is fully open and that cylinder is not empty)	Replace regulator
<b>Pilot lights but Heater flame is "lazy" or has low output.</b>	Faulty Regulator (First insure cylinder valve is fully open and that cylinder is not empty)	Replace regulator

## Service

- Repair to gas passages and associated components should be done only by a qualified service person.
- Owner repair & service should be limited and performed only to the following:
  - Mantle replacement
  - Glass replacement
  - Reflector replacement

# Replacement Parts - Patio Heater & Light

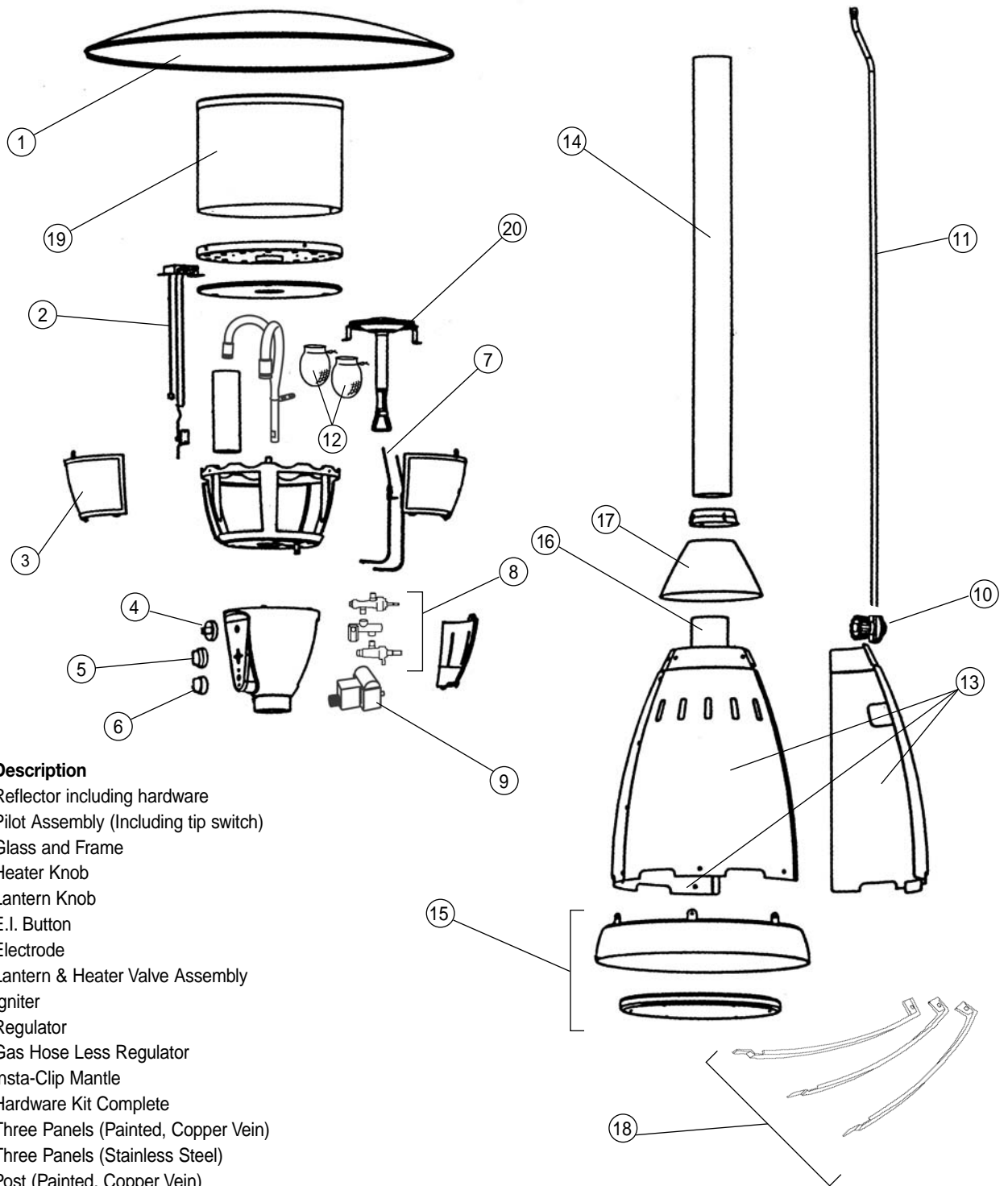

No.	Part No.	Description
1	5040-1541	Reflector including hardware
2	5040B5441	Pilot Assembly (Including tip switch)
3	5040-1221	Glass and Frame
4	5040-1461	Heater Knob
5	5040-1511	Lantern Knob
6	5040-1451	E.I. Button
7	5040-3101	Electrode
8	5040-5571	Lantern & Heater Valve Assembly
9	5040-2211	Igniter
10	5040-5261	Regulator
11	5040-5651	Gas Hose Less Regulator
12	21A122	Insta-Clip Mantle
	5040-0801	Hardware Kit Complete
13	5040-4481	Three Panels (Painted, Copper Vein)
	5040-4461	Three Panels (Stainless Steel)
14	5040-4781	Post (Painted, Copper Vein)
	5040-4711	Post (Stainless Steel)
15	5040-1751	Base Assembly with Wheels
16	5040-4881	Post Mount (Painted, Copper Vein)
	5040-4841	Post Mount (Stainless Steel)
17	5040-1381	Post Mount Cover (Painted, Copper Vein)
	5040-1281	Post Mount Cover (Stainless Steel)
18	5040-0781	Three Support Brackets (Painted, Copper Vein)
	5040-0741	Three Support Brackets (Stainless Steel)
19	5040-1141	Heater Burner Screen
20	5040-1181	Burner

## Parts List

No.	Part No.	Description
1	5040-1081	Table Assembly (Painted, Copper Vein)
	5040-1021	Table Assembly (Stainless)
2	5040-0881	Table Support & Hardware (Painted, Copper Vein)
	5040-0891	Table Support & Hardware (Painted, Silver)
3	5040-0181	Clamp (Painted, Copper Vein)
	5040-0191	Clamp (Painted, Silver)

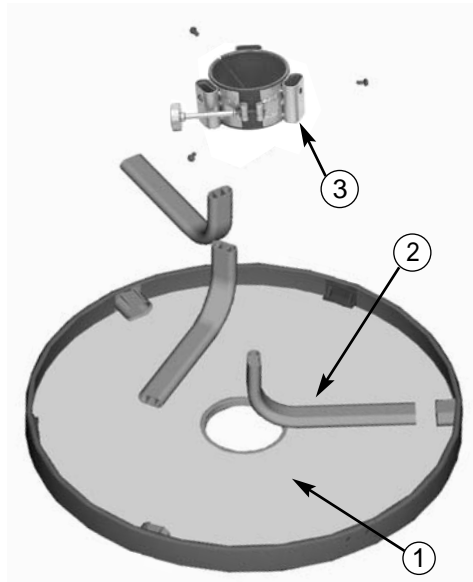

## Coleman Limited 7-Year Warranty

Coleman will repair or replace, at its option, this product or any component found to be defective in materials or workmanship within seven years of the original retail purchase.

This warranty is valid for the original retail purchaser from the date of initial retail purchase and is not transferrable. Keep the original sales receipt. Proof of purchase is required to obtain warranty performance. Coleman dealers, service centers, or retail stores offering Coleman products do not have authority to alter, modify or in any way change the terms or conditions of this warranty.

### WHAT IS NOT COVERED

- Cost of shipment to Coleman
- Normal wear and tear, including chips, scratches, abrasion, discoloration or fading from use or exposure to sunlight
- Damage caused by misuse, abuse, neglect, alterations, repairs by unauthorized persons, use of non-Coleman accessories or parts, or failure to follow recommended care or maintenance instructions
- Products used for commercial purposes or in profit or non-profit instructional or rental operations
- Mantles, generators, light bulbs, batteries or fuel
- CONSEQUENTIAL DAMAGES, INCIDENTAL DAMAGES, OR EXPENSES, INCLUDING DAMAGES TO PROPERTY. SOME STATES/PROVINCES DO NOT ALLOW THE EXCLUSION OR LIMITATION OF INCIDENTAL OR CONSEQUENTIAL DAMAGES, SO THE ABOVE LIMITATION OR EXCLUSION MAY NOT APPLY TO YOU.

### IMPLIED WARRANTIES

Any implied warranties, either statutory or otherwise, including implied warranties of merchantability and fitness for a particular purpose, shall be limited to the duration and terms of the express warranties set forth in this limited warranty. Some states/provinces do not allow limitations on how long an implied warranty lasts, so the above limitation may not apply to you.

### HOW TO OBTAIN WARRANTY PERFORMANCE

Take the product to an authorized Coleman Service Center. If one is not conveniently located, attach a tag to the product which includes your name, address, telephone number and description of the problem. Include a copy of the original sales receipt. Carefully package the product and send either by UPS or Parcel Post **insured** with shipping and **insurance** prepaid to: USA: The Coleman Company Inc., 3600 N. Hydraulic, Wichita, KS 67219, or CANADA: The Canadian Coleman Co., Ltd., 5975 Falbourne Street, Mississauga, Canada L5R 3V8. Please do not mail products with fuel in tanks, or with disposable propane cylinders. Remove glass globes from lanterns.

If you are located outside the United States or Canada, return this product to the place you purchased it, or to any other retailer seller of similar Coleman products, and request warranty assistance. If you are unable to obtain warranty assistance, then you may call any of the following Coleman offices for further assistance:

[www.coleman.com](http://www.coleman.com)

The Coleman Co., Inc.  
3600 N. Hydraulic  
Wichita, KS 67219 U.S.A.  
1-800-835-3278  
TDD: 316-832-8707



The Coleman Co., Inc. • 3600 N. Hydraulic  
Wichita, KS 67219 U.S.A.  
1-800-835-3278 • TDD: 316-832-8707