

# SERVICE MANUAL

## **KitchenAid MIXERS**



KSMC50  
K5SS



K45SS

## **SOLID STATE**



KSM90

10

# TOOLS REQUIRED



SPEED TOOL  
#4164839



5/32" DRIFT  
PUNCH

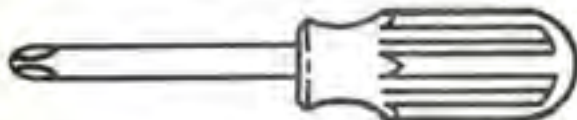

PHILLIPS

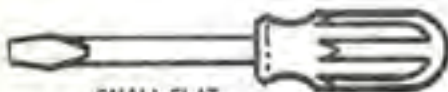

SMALL FLAT  
SCREWDRIVER

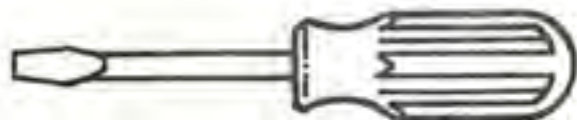

STRAIGHT

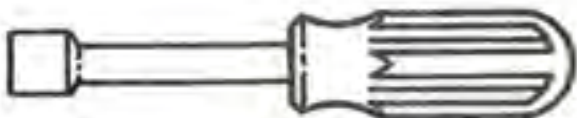

1 NUT DRIVER  
3/8" HOLLOW  
SHANK

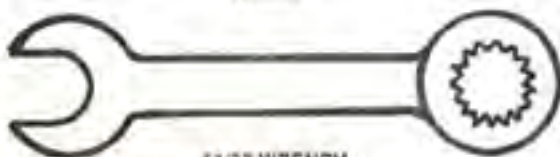

1 1/32 WRENCH

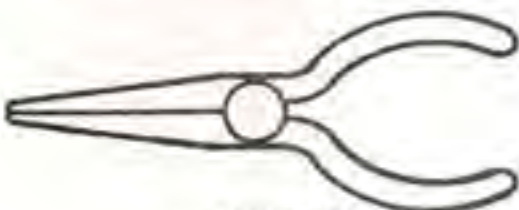

NEEDLE NOSE

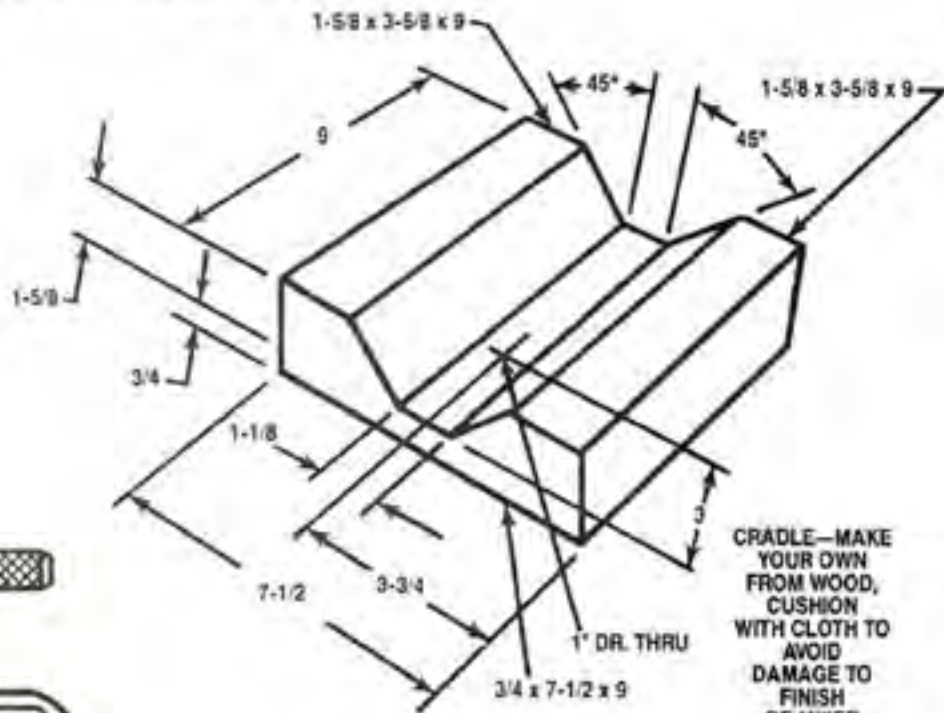

CRADLE—MAKE  
YOUR OWN  
FROM WOOD,  
CUSHION  
WITH CLOTH TO  
AVOID  
DAMAGE TO  
FINISH  
OF MIXER



SMALL HAMMER



RUBBER/  
RAWHIDE  
MALLET

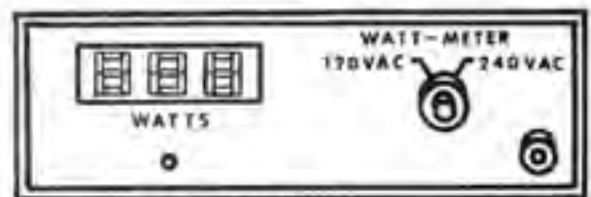

WATT METER  
HELPFUL

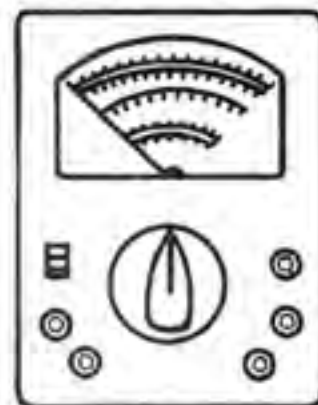

V.O. METER

## INTRODUCTION

All KitchenAid mixers are well designed and carefully built. Normally they will give continual use year after year without requiring service attention.

Careful records have been maintained over a period of years to determine and correct, through improved design, any troubles that might possibly develop. An effort has been made in preparation of this manual to cover them all.

**CAUTION:** Always remove power cord from electrical outlet before disassembly of any part of the mixer.

# KITCHENAID MODELS

K45SS

KSM90

K5SS

KSMC50

## INDEX

SECTION		PAGE
1	Disassembly of Gear Case and Planetary . . . . .	2
2	Disassembly of Motor and Control Unit . . . . .	5
3	Repairs to Motor and Control Unit . . . . .	9
4	Repairs to Gear Case and Planetary . . . . .	13
5	Repairs to Pedestal . . . . .	18
6	Adjustment of Control Unit . . . . .	19
7	Repairs to Bowl Lift Assembly . . . . .	21
8	Troubleshooting the Bowl Lift Assembly . . . . .	25
9	Troubleshooting the Mixer . . . . .	25
10	Wiring Diagram . . . . .	28



# GENERAL INFORMATION

## NORMAL PERFORMANCE

The KitchenAid mixer is powered with a universal motor which will operate on 50 or 60 hertz, alternating current only. The voltage of the power supply should be within 10 volts either way of the voltage stamped on the trim band and name plate.

A mixer in good running condition will start turning slowly when the switch lever is moved from the "OFF" to the stir position. As it is moved to successively higher positions, the speed of the beater increases until the #10 or high speed is reached. At stir position, the planetary should turn at approximately 60 RPM, at the #10 position the K45SS should turn at approximately 280 RPM, while all other models turn at approximately 255 RPM. The mixer will run quietly in the lower speed range; however, some noise can be expected on the higher speed settings due to the hum of gears and the motor.

When the mixer is first turned to the stir position, there may be a slight clattering, irregular noise. This noise will disappear as the lubrication in the gear case warms up.

The switch lever should move freely with the "feel" of the definite positions for speed numbers stir, 2, 4, 6, 8 and 10. Speed numbers 3, 5, 7 and 9 do not have definite notches.

## POWER

A mixer will have full power on all speed settings. To check for full power, hold the planetary with one hand and move the switch lever on and off with the other hand. At the stir position, it should not be possible to stall the planetary except by a very great effort, nor should the planetary slow down noticeably when the retarding pressure is applied.

## HEATING

Under normal conditions, the mixer will not show any tendency to heat because of the built-in ventilating system in the motor. Under heavy loads with extended mixing time periods, the mixer head may heat up to the point of being uncomfortable to touch.

## SPEED CONTROL

The speed control of the mixer is attained through the use of a governor assembly mounted at the rear of the control plate assembly. The electrical circuit is made and broken by the action of the fly ball governor revolving against the control plate.

When the switch lever is moved to an ON position, the position of the control plate with respect to the governor is changed by the action of the switch lever. Thus, when the control plate is set close to the governor, a relatively low speed of the motor causes the governor to make or break the electrical circuit through the control plate. When the control plate is set farther away, a greater motor speed is required before the governor starts breaking circuit.

The action of the governor is such that the speed of the motor will remain constant for a given setting of the control plate within certain loads. After certain loads have been exceeded the speed of the motor will drop to meet the torque requirements of the given load.

Speed is controlled by the governor and control plate in conjunction with the phase control. A device called a triac is a part of the phase control circuit. This device determines the amount of power the motor sees dependent upon the condition of the control board contacts. If both contacts are open, about 40 volts RMS is applied to the motor and about 80 volts is applied when either contact is closed and the other is open. When both contacts are closed, the triac is full on; consequently, full power is applied to the motor. In this way, the speed is controlled. If the motor begins to run too fast for a particular speed setting, one or both contacts open which cuts back on the voltage the motor sees, thus slowing it up. If the motor operation becomes too slow, one or both contacts will close, applying the needed voltage to the motor to sufficiently increase motor speed. This is always accomplished through the triac. The control plate contacts control the triac and it in turn, controls the amount of power supplied to the motor.

## BEATER

The beater should fit freely on the beater shaft located in the planetary. Power is transmitted from the motor to the center gear and bevel gear assembly by means of the worm gear. The center gear and bevel gear assembly engages the beater pinion, located in the planetary, to turn the beater shaft. The attachment hub bevel gear also meshes with the center gear and bevel gear assembly to transmit power when various attachments are being used.

## LUBRICATION

Under normal service conditions the mixer will not require lubrication for many years. The gear case is packed with an ample supply of Shell Darina #2 grease (6 fluid ounces) which lubricates all the gears and shafts. The motor bearing and the beater shaft bearing are oil impregnated. The rear motor bearing has a felt washer which has been presoaked in oil. The front motor bearing is a ball bearing.



## SECTION 1

### DISASSEMBLY OF GEAR CASE AND PLANETARY

- A. All solid state KitchenAid mixers have the same motors and control parts and the gear in the gear case are alike with one exception. Planetary parts are all the same except that some early production K5SS had a lead weight. Gearing and motor instructions are for both machines and any differences will be pointed out. The model K5SS and KSMC50 have an entirely different bowl and bowl lift. On these models, the bowl is raised and lowered and on models K45SS & KSM90, the entire head is lifted. The bowl, column, base and bowl lift are covered separately in Section 7.
- B. Before repairs are attempted on any KitchenAid mixer, a watt test should be made. To make the test, plug the wattmeter into the proper voltage (Fig. 1).



Fig. 1

Plug the cord from the mixer into the wattmeter. Turn on the current and run the mixer. If the dial shows up to 135 watts, going from stir to high speed, the mixer is in good condition. If the reading is 175 to 400 watts, there is trouble. High wattage readings indicate either electrical or mechanical problems. Check first for bearing/gear drag, then for motor/brushes problems.

**CAUTION:** Always remove power cord from electrical outlet before disassembly of any part of the mixer.

- C. To save the paint, lay the gear case and motor housing in a padded cradle or on a cloth pad. To remove the planetary, first remove the drip cup. The drip cup fits the gear case bottom cover tightly and must be started off the cover by tapping it (Fig. 2). Use a screwdriver on the upper edge of drip cup and tap screwdriver gently to remove the drip cup.



Fig. 2

- D. With  $\frac{5}{32}$ " drift punch, remove the groove pin that holds the planetary to the vertical center shaft (Fig. 3). With pin out, the planetary can be pried off the shaft. With two screwdrivers, pry the planetary down and off the shaft (Fig. 4).



Fig. 3



Fig. 4

- E. Remove the #6-32 x  $\frac{3}{8}$ " oval head screw and take off the end cover (Fig. 5). Unscrew and remove the two #6-32 x  $\frac{3}{16}$ " binding head screws that hold the trim band to the gear case and motor housing (Fig. 6). With screws out, remove the trim band.



Fig. 5



Fig. 6

- F. If necessary to remove the pedestal from the gear case bottom cover, loosen the setscrew with a screwdriver (Fig. 7). With a drift punch and hammer, drive out the hinge pin (Fig. 8) and lift the pedestal off the gear case bottom cover.

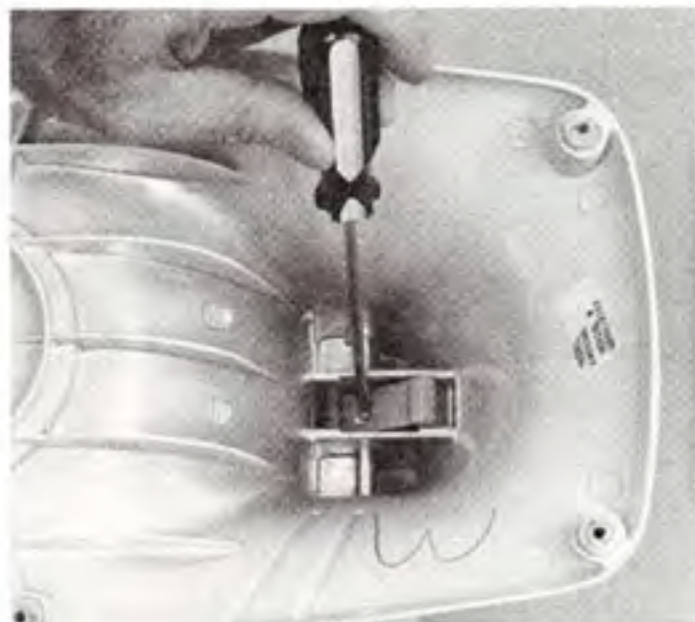

Fig. 7



Fig. 8

- G. Remove the cord flag terminals from control board and ground wire from bearing bracket (Fig. 9).



Fig. 9





Fig. 10

To remove the bottom cover from the gear case and motor housing, unscrew and remove the five special screws (Fig. 10).

These screws hold the internal gear to the gear case. Unscrew and remove the four #10-24 fillister head screws from the bottom cover (Fig. 11). With pedestal in locked position, gently tap end of pedestal with heel of hand to remove bottom cover (Fig. 12). The transmission gears, the cord and plug will come out with the cover.



Fig. 11



Fig. 12

- H. To remove the cord and plug from the bottom cover, use a pair of heyco pliers and squeeze the heyco strain relief and pull out (Fig. 13). To replace the cord and plug, reverse this procedure.



Fig. 13

- I. Remove the attachment hub bevel gear from the gear case and motor housing. This gear can be removed by simply pulling it out of the attachment hub (Fig. 14). It will clear the worm on the motor shaft. Due to the slow speed of this gear, there should be no trouble with the shaft galling and it should be easy to remove.

*NOTE: For clarity, the pictures in this manual have no grease shown in gear case, normally the gear case has 6 oz. of Shell Durina #2 grease surrounding the gears.*



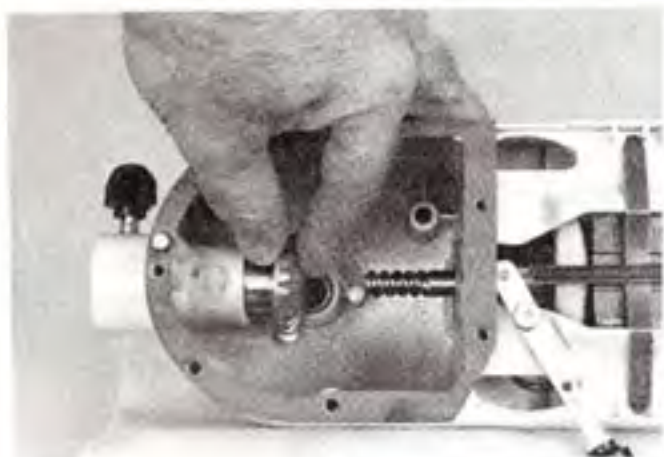

Fig. 14

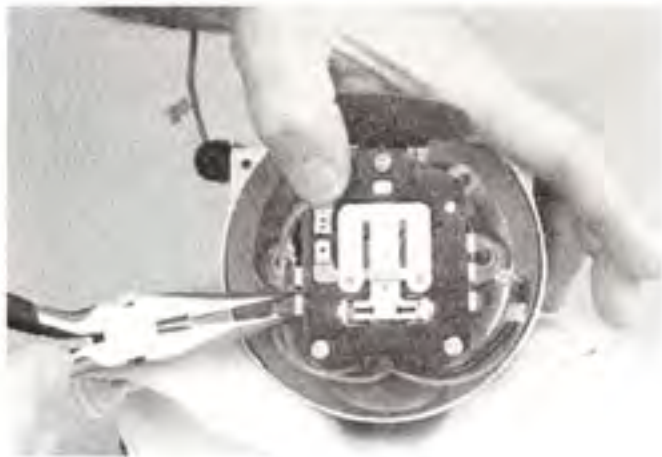

Fig. 16

- J. Clean out the gear case. Remove as much of the grease as possible. The gear case may be thoroughly cleaned when the motor has been removed.

## 2

### DISASSEMBLY OF MOTOR AND CONTROL UNIT

- A. Start disassembly of the control unit by removing the flag terminals from the stator (Fig. 15). Remove the end seal and disconnect the terminals from the phase control (Fig. 16). Unhook the control board spring at the bottom of the control board (Fig. 17). Unlock the two lock nuts on the control board and unscrew the two adjusting screws. The control board can now be removed (Fig. 18).



Fig. 17

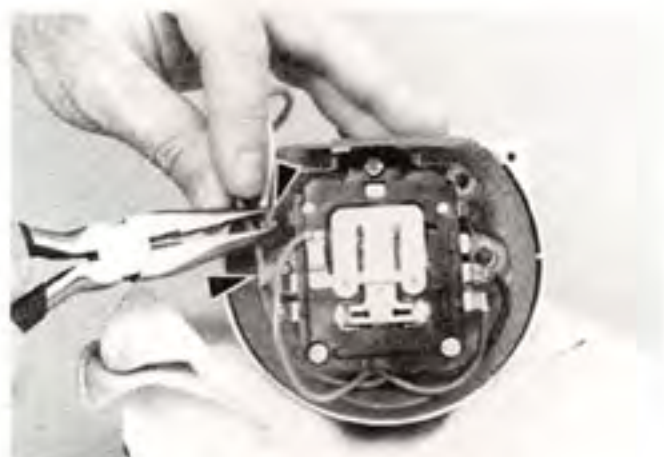

Fig. 15

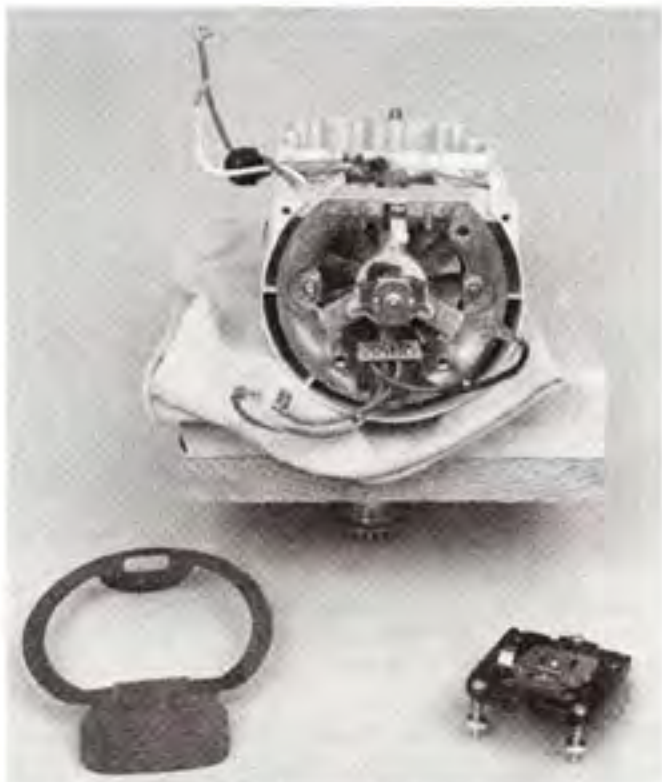

Fig. 18

- B. The phase control unit can now be disassembled from the bearing bracket, if need be, by unscrewing the #4-40 x 1/4" pan head screw (Fig. 19 & 20).



Fig. 19



Fig. 21

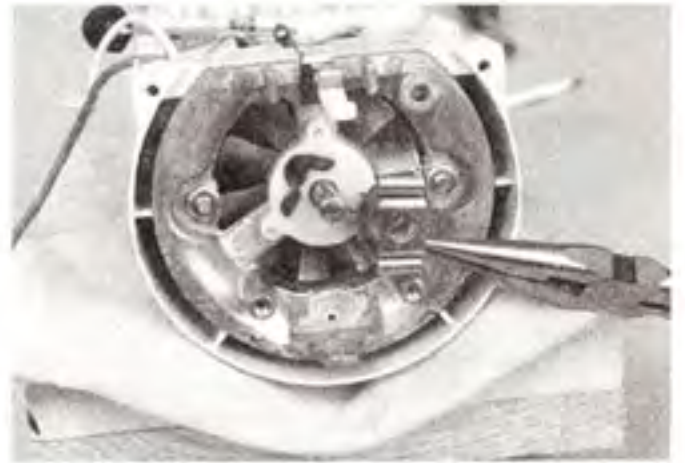

Fig. 22



Fig. 20

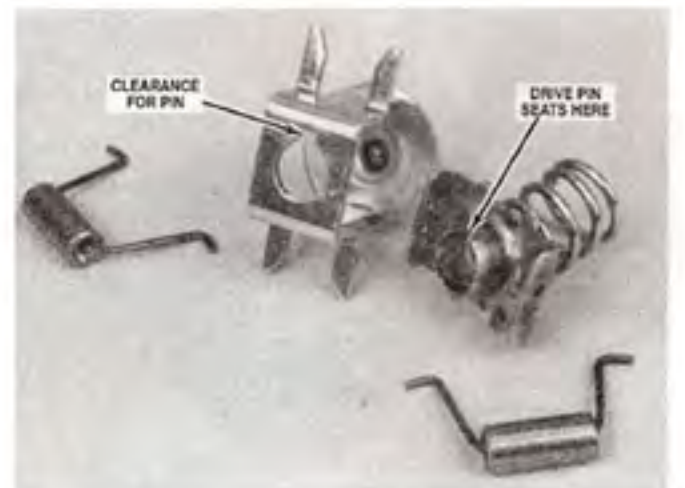

Fig. 23

- C. With two screwdrivers, carefully pry off the governor assembly. Do Not Bend. Remove the governor drive stud and lay it away so it will not be lost (Fig. 21, 22 & 23).



- D. To remove the speed control link and cam assembly, take out the pivot screw and tension washer (Fig. 24 & 25). The speed control link and cam assembly can be removed by pulling it out at the gear case and motor housing (Fig. 26). Before pulling it out, remove the flat spring.

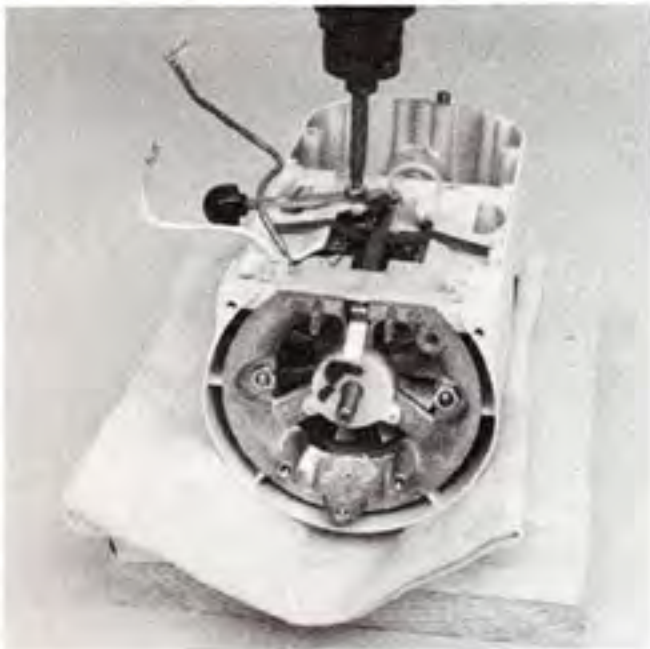

Fig. 24

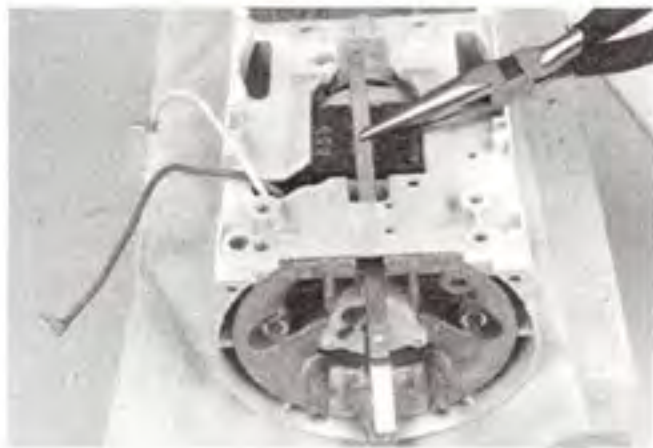

Fig. 26

- E. Unscrew and remove the two #10-24 nuts (Fig. 27), remove the bearing bracket (Fig. 28), and then the motor stud sleeve (Fig. 29).

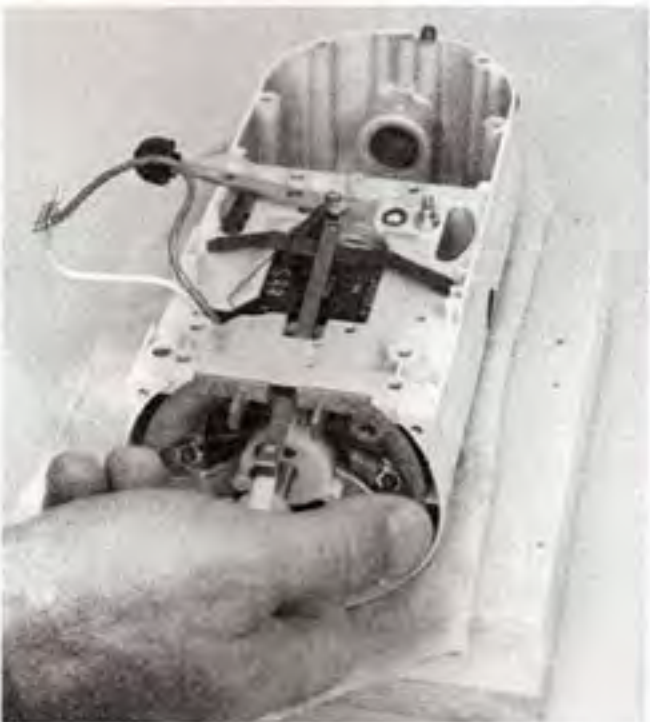

Fig. 25

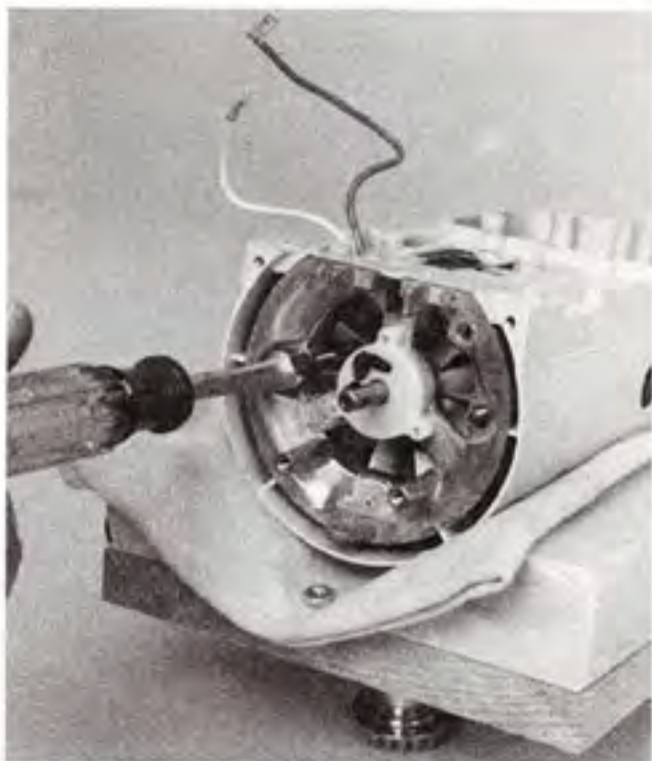

Fig. 27



Fig. 28



Fig. 29

- F. Unscrew the two brush holder screw caps and remove the brushes and springs (Fig. 30).



Fig. 30

Viewing from the rear, mark the brushes right and left, and also the top of the brush, just as it was removed from the motor.

- G. The armature can now be removed. With attachment hub bevel gear removed, insert drift punch through attachment hub opening and gently tap armature straight back through the stator using a block of wood to protect the shaft (Fig. 31).



Fig. 31

- H. Pull the two wires, from rear of the stator, through the slot in gear case and motor housing so they are inside the gear case and motor housing (Fig. 32). With long pliers, pull the brush clips from the motor out of the brush holders. Remove the two #10-24 nuts. Remove one stator screw and pull out the stator (Fig. 33). To pull the stator out, reach into the gear case and motor housing and grasp the stator at the front and pull it out.



Fig. 32



Fig. 33



- I. To remove the brush holder housings, it will be necessary to unscrew the other stator screw. Under the stator screws are #10-24 x 1/4" cup point setscrews. With a small flat screwdriver (Fig. 34), unscrew the setscrews a few turns and push the brush holders housings out by hand, inside the gear case and motor housing.



Fig. 34

### SECTION 3

#### REPAIRS TO MOTOR AND CONTROL UNIT

- A. Clean the brush holder housings with solvent and wipe them dry with a clean dry cloth. Install the brush holder housings into the gear case and motor housing so that the rim on the holder seats against the c'bore step in the gear case and motor housing.
- B. Clean the brush holder inserts with solvent and wipe them dry with a clean dry cloth. Install the brush holder inserts into brush holder housings. They must be oriented, viewing the gear case and motor housing from the rear, as shown below (Fig. 35). Lock the brush holder housings with insert in place with the #10-24 x 1/4" cup point setscrews.

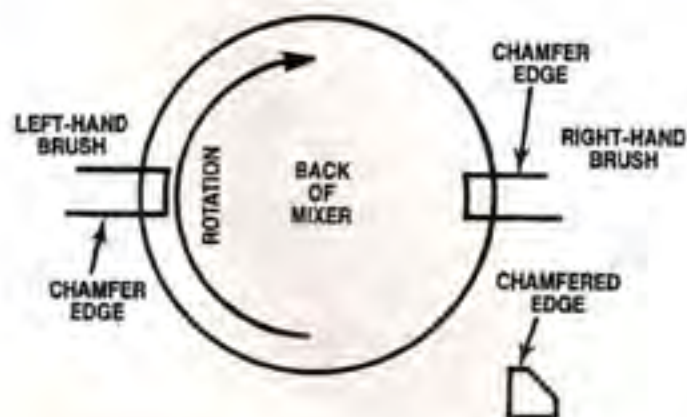

Fig. 35

**NOTE:** Early production solid state mixer utilized a square brush and brush holder. Square brushes are no longer available. Brushes with chamfered edges will fit into square brush holders.

- C. Test the stator with an ohmmeter (Fig. 36). Set the ohmmeter on the 1X scale and set it at "0." In upper coil, connect one of the ohmmeter leads to the red wire and the other lead to the black wire from the upper coil. If the ohmmeter shows a low resistance reading, the coil is good. Check the other coil the same way. If the needle on ohmmeter deflected to zero or if there was no deflection, the coil is bad and stator must be replaced.



Fig. 36

- D. Assemble the two stator screws and tighten them by using long nose pliers and turn them slightly. Be sure the nose of the pliers is placed on the stator screws in the area that the stator seats so threads will not be deformed. Start the stator on the two stator screws and onto the ribs of the gear case and motor housing (Fig. 37). The two lead wires from the rear of stator must be on the same side as the slot in the gear case and motor housing. Insert the stator brush clips between the brush holder housing and brush holder insert. (A slot is provided in the brush holder housing for this brush clip). Insure that the brush clips are pushed in all the way so the brush and commutator on armature will clear them when assembled.



Fig. 37



- E. Push the stator back as far as it will go, then place the #10-24 nuts on each stator screw. Tighten both nuts. Put the two wires from the stator through the slot in the bottom of the gear case and motor housing (Fig. 38). Place the motor stud sleeve over the motor stud and wrap the white wire from stator between the motor stud sleeve and the gear case and motor housing.



Fig. 38

- F. Check the armature on a growler or take the armature to an electric motor repair shop and let them test it. If it is not in good condition, replace it with a new one.
- G. Check the ventilating fan. Straighten the blades if they are bent (Fig. 39). If a new armature is replaced, move the washers from the old armature to the fan end of the new one. Oil the worm and shaft and install the armature in the gear case and motor housing (Fig. 40). If necessary, tap end of armature shaft with non-metallic mallet to seat bearing.



Fig. 39

- H. Check the bearing in the bearing bracket (Fig. 41). To replace the bearing, remove the three #4-40 x 1/2" pan head screws and lift off the bearing retainer. Take out the old bearing. Place new bearing in cavity with square notch toward the top of the bracket. Soak the felt washer in bearing cap with oil. Place the retainer on the bearing so that the tongue fits into the square notch, then screw in the three screws.



Fig. 40



Fig. 41

- I. Install the bearing bracket. Start bracket onto the two stator screws. Push the bracket back until stator screws are through the bracket. Start the two nuts on the stator screws and turn them until bearing bracket is seated (Fig. 42).



Fig. 42



- J. Check the armature for end play. With the thrust bearing assembly seated properly and proper amount of spacing washers at the rear, there should be only a perceptible amount of end play to assure free operation of the armature. If there is too much end play, add another thin washer. To do this, remove the bearing bracket and add the washer to the armature shaft, then reassemble the bearing bracket into the gear case and motor housing.
- K. If the old brushes are more than  $\frac{5}{16}$ " long, assemble them in the brush holders. From the back of the unit put brush marked "right" in right side brush holder, be sure the side marked "up" is at the top. Push brush in and lock it in place with a brush holder screw cap (Fig. 43). Place left hand brush in the mixer in the same way.



Fig. 43

- L. Place the speed control link and cam assembly through the slot in the bearing bracket with the cam portion of the speed control link and cam assembly toward the top of the gear case and motor housing. Place flat spring in position and slide the speed link and cam assembly over the flat spring (Fig. 44). Place the speed control spring on the switch lever stud. Place the speed control link and cam assembly over the stud on the switch lever. Place the tension washer on the pivot screw and screw it into the gear case and motor housing until tight (Fig. 45).



Fig. 45

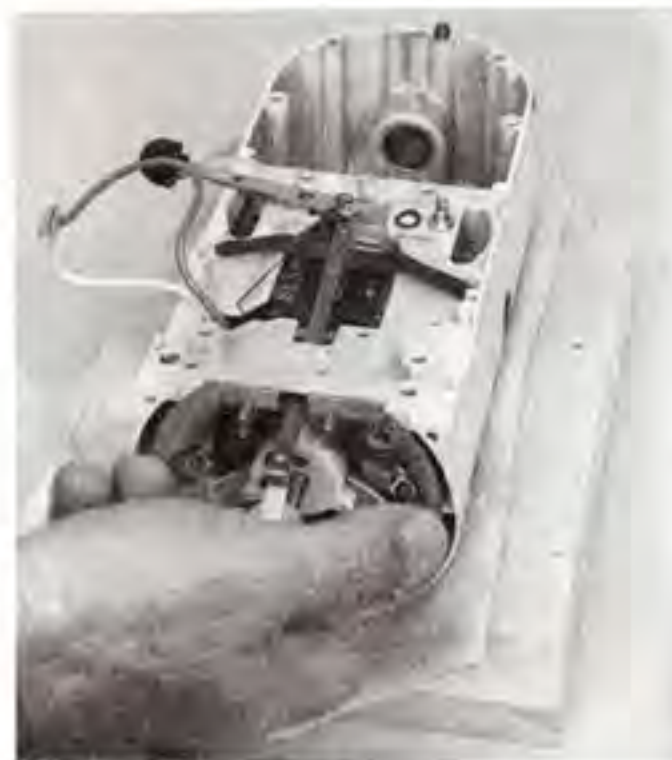

Fig. 44

- M. If the spring in the governor is rusty, replace the governor assembly. Place the governor drive stud in the armature shaft. With drive stud at top of shaft, place the governor on the shaft with the keyway up. Push the governor onto the shaft as far as it will go (Fig. 46 & 47).



Fig. 46



Fig. 47

**NOTE:** Never attempt to take governor apart. The purpose of this photo is to show where governor seats on drive pin.

**CAUTION:** Do not drive against the ball as this will cause damage (Fig. 48).



Fig. 49

**CAUTION:** Do not attach the phase control excessively tight as this pressure could deform the heat sink resulting in damage to the control.

- O. Place the control plate on the bearing with adjusting screws at the top (Fig. 50). Turn in the screws until about  $\frac{3}{8}$ " of the screw remains. Have both screws turned in evenly so the opposite end of the control plate rests squarely on the extensions on the bearing bracket.



Fig. 48

- N. If the phase control was removed or replaced, make sure the heat sink on the triac unit has sufficient amount of thermal conductive compound applied to that surface before assembling. Place the #4-40 x  $\frac{1}{4}$ " pan head screw through the hole in the triac and screw it into the bearing bracket (Fig. 49) until it is tight (4-5 in. lbs.).



Fig. 50



- P. With long nose pliers, hook the control plate spring into the hole on the bottom part of the control plate. Place end seal onto mixer. Connect the two flag terminals from the stator and the four flag terminals from phase control to the control plate (Fig. 51). See wiring diagram for proper connections. Be certain flag terminal connections to control plate are tight. If necessary, crimp terminals with needle nose pliers.



Fig. 51

*NOTE: Leave the control unit. It is now ready for timing, but a better job can be done when mixer is completely assembled.*

## SECTION 4

### REPAIRS TO GEAR CASE AND PLANETARY

*NOTE: Grease not shown in these pictures.*

- A. Examine the brass bearings in the attachment hub and the roof of the gear case. These bearings are cast in the housing. If they are worn badly, the entire housing must be replaced. However, shafts turn slowly in these bearings and the bearings have a long life.



Fig. 52

- B. Examine the attachment hub bevel gear. If it shows wear in the teeth, it should be replaced. To replace the bevel gear, coat the shaft with a film of good oil. Push it into the attachment hub bearing from inside the gear case (Fig. 52). It does not have a washer, so push it in as far as it will go.

- C. With a Phillips screwdriver, remove the three #10-24 x 7/16" Phillips fillister head screws and lock washer assemblies and lift out the worm gear bracket, bearing and pin assembly (Fig. 53).



Fig. 53



Fig. 54

- D. Remove the center gear, bevel gear and vertical center shaft. Push vertical center shaft upward exposing pin (Fig. 54).



Fig. 55

Pull out with fingers. Remove shaft from bottom of gear case cover (Fig. 55). Check shaft for bearing wear. Dark gray or indented surfaces indicate shaft should be replaced. Lift gears from case for inspection (Fig. 56).



Fig. 56

- E. Check the lower center bearing for wear. This is an oilless bearing and should be in good condition. If it is worn, the gear case bottom cover will have to be replaced since the bearing is an integral part.
- F. If the attachment hub bevel gear was replaced, then the bevel gear on the center gear and bevel gear assembly must also be replaced.
- G. Place the same washer on lower center bearing. Place the gear assembly on top of center bearing. Insert end of vertical shaft opposite "O" ring into bottom of lower gear case (Fig. 55). Push shaft upward and insert pin (Fig. 54). Center pin in shaft and lower shaft into gear assembly. Turn shaft until pin seats and gears and shaft turn together. Wipe all excess lubricant from bottom of vertical shaft on "O" ring.
- H. Check the worm gear (Fig. 57), the shaft and pinion. To replace these two gears, drive out the groove pin (Fig. 58). Make a note of positions of fiber washers. They will be installed the same way with new gears. From the top of the worm gear bracket, drive out the shaft and pinion.



Fig. 57



Fig. 58

*NOTE: The shaft and pinion has 11 teeth on the K45SS mixer. This part on all other models has 10 teeth.*

- I. Start a new shaft and pinion from bottom of bracket. Before the shaft emerges from lower bearing, place the washer on bearing and start shaft into the washer. Hold a new worm gear next to washer and push shaft into gear. Before shaft emerges from gear, place washer in place and push shaft through washer and into the upper bearing. Line up the pin holes and drive in the pin.





**Fig. 59**

- J. Place the worm gear assembly and bearing bracket on the gear case bottom cover so that the two dowels will fit into the base of the bearing bracket (Fig. 59). Place the three screw and lock washer assemblies in the holes and screw them into the bottom cover (Fig. 60). Be sure these screws are tight.



**Fig. 60**

- K. Check the latch, link and lever assembly. There should be no wear or trouble with this assembly (Fig. 60).

- L. Use 6 oz. of Shell Darina #2 lubricant and pack around the gears when filling the gear case. This is available through your nearest authorized parts distributor. Try to keep the bearing in roof of gear case open, it will help when assembling the bottom cover and the gear case housing.

- M. Clean the gasket surface of the gear case. Place a new gasket on the bottom cover, over the dowel and press it down so it will stay in position (Fig. 61).



**Fig. 61**

- N. Check the cord and plug. If it is drying and cracking, replace it.
- O. Lock latch lever and hold the bottom cover in position over the gear case and motor housing and start joining the two together (Fig. 62). Start the shaft into the upper bearing and slowly push the parts together.



**Fig. 62**

**CAUTION:** Do not force the gear cases together. If gears are properly aligned, these two parts will assemble easily with little or no force required.

- P. If necessary to replace internal gear, pry gear from gear case cover (Fig. 63). When installing new gear, align notches with holes in gear case and tap evenly into place using non-metallic mallet. Turn the five special screws (Fig. 64) evenly and tightly (18-20 in. lbs.). Then screw in the four #10-24 x 1" fillister head screws and turn them in evenly and tightly (Fig. 65).



Fig. 65

- Q. Fill the teeth of the internal gear with Shell Darina #2 lubricant.

- R. Check the condition of the planetary. If there is any play in the agitator shaft and the bearing (not shown), replace the planetary and the shaft. The bearing is an integral part of the planetary. Hold agitator shaft firmly and remove pinion retaining clip (Fig. 66). Lift off the pinion. Take out the pin and remove the washer (Fig. 67). Pull out the agitator shaft (Fig. 68).

- S. The agitator shaft is complete as an assembly. Oil the shaft and push it up into the bearing as far as it will go. Place the washers on shaft. Place the pin through the shaft. Set the pinion gear on shaft and straddle the pin. Place the retaining clip on shaft (Fig. 66).



Fig. 63



Fig. 64



Fig. 66





Fig. 67

- T. Be sure the planetary pinion and internal gear have a light coat of grease, Shell Darina #2 lubricant.



Fig. 68



Fig. 69

- U. Place the washers on the vertical shaft. Place the planetary on the shaft and push it up to the washers. There should be a perceptible amount of end play. Line up the holes in the planetary and shaft. It may be necessary to use a scribe to hold shaft up to align holes (Fig. 69). Drive in the groove pin (Fig. 70). Place the drip cup on the gear case.



Fig. 70

- V. Check the adjusting screw (Fig. 71). This screw is slotted and has a nylon insert. As it is screwed in, the threads are cut in the nylon and hold the screw tight. Replace this screw if it is loose in the threads.



Fig. 71

## SECTION 5

### REPAIRS TO K45SS & KSM90 PEDESTAL

- A. If pedestal were removed, check the hinge pin. If it is galled from failure to loosen the setscrew, replace it (Fig. 72). Loosen the setscrew so that it will clear the hinge pin. Place the new hinge pin in the pedestal, but do not drive it in.



Fig. 72

- B. Check the rubber feet. If they are worn or softened from grease, replace them. Twist the old feet out (Fig. 73). Clean the holes with solvent and dry them with clean cloth. Moisten the part of the foot that will go into the hole and twist the new feet in or tap with mallet. Be sure all feet are in the same amount.



Fig. 73

- C. If the bowl screw cap has worn out, replace it. To remove the old cap, take out the three #10-24 x 1/2" flat head screws and lift out the old cap. Place new cap in place and screw it down tight with the three screws (Fig. 74).



Fig. 74

- D. While in cradle, place the pedestal on the gear case and motor housing. Line up the holes for the hinge pin and drive it in so that an equal amount of the pin extends on each side of the pedestal (Fig. 75).



Fig. 75

- E. With a screwdriver, reach up inside pedestal and tighten the hinge pin setscrew (Fig. 72).



## SECTION 6 ADJUSTING OF CONTROL UNIT



Fig. 76

**NOTE:** When replacing a control plate, a rag, as pictured in figure 76, hooked over control plate spring, will keep spring accessible, not allowing it to "snap" between upper and lower gear case.

- After installing new parts in the control unit, the control plate must be adjusted so that all speeds will be the same as they were when the mixer was new.
- Make sure that all of the wire leads are properly connected and that they are locked in position properly. Plug the cord into a receptacle having the proper voltage.
- To adjust the speeds, move the switch lever to stir. This may or may not start the motor. If motor did not start, turn out the two adjusting screws evenly and stop when planetary turns about 60 revolutions per minute. To test the speed, hold a finger of the right hand at the planetary. Let beater shaft hit finger (Fig. 77). Count the number of times the finger is touched in 15 seconds. Adjust the two screws until the shaft touches the finger about 15 times.



Fig. 77

- When proper speed has been set, lock the two lock nuts using  $11/32$ " wrench (Fig. 78) and check the speed again. If a small correction must be made, make it without loosening the lock nut. Test speeds as before and when correct, it will not be necessary to disturb the lock nuts.



Fig. 78

- Move the switch lever to speed #6. At this setting, the planetary must turn 180 revolutions per minute. Check the speed as was done for 1st speed. The planetary should touch your finger 15 times in 5 seconds. If it touches the finger less than that, turn the adjusting screw at bottom of the control plate (Fig. 79).



Fig. 79

Check the revolutions again and keep adjusting the screw at the bottom until the right speed is reached. There is no need for locking this screw.

- Try all speeds from stir to #10. If stir and #6 speeds are properly adjusted, the other speeds should automatically be correct. If there is a definite change in speed between #8 and #10, the control unit is correctly adjusted.



Fig. 80

A speed tool (strobograph) is available to adjust planetary speed settings on all KitchenAid mixers. Available through LaPorte, part #4164839. (Strobe only works with fluorescent light.)



Fig. 81



Fig. 82

One side (Fig. 81) is used for K45/K45SS and K5/K5A/K5SS/KSM90/KSMC50. The other side (Fig. 82) is used for model 4-C.

To use, insert into the attachment hub of the mixer with the correct side of the disc facing the rear of the mixer (if adjusting a K45, that side of the disc faces rear of the machine). "Rule of thumb": Control plate is spaced  $\frac{3}{8}$ " from mounting bracket (from nut to control board) for proper speed adjustment "starting point."

Turn mixer to "stir speed" using Graph A for model K45 and K5 (non-solid state) or Graph B for solid state models. The mixer may or may not start. If not, turn out the two mounting screws of the control plate evenly until the graph "stands still."

Turn mixer to speed #6 and Graph C should "stand still." Adjusting the single screw at the bottom of the control plate will affect this speed setting.

Turn mixer to speed #8, listen to it and also watch Graph D. Graph D *should not* be standing still on speed #8.

Turn mixer to speed #10. There should be a difference you can hear between speeds #8 and #10—Graph D should "stand still" on speed #10. If an adjustment is needed, use the single screw on the bottom of the control plate.

When proper speeds have been set, lock the two lock nuts on the upper mounting screws using  $\frac{11}{32}$ " wrench. Be careful not to move the mounting screws in or out during the locking process.

Recheck speeds after locking the nuts and if a fine adjustment has to be made, it can be done without loosening the locking nuts.

The same procedure applies to the 4-C (Fig. 82), using Graph A for speed #1, Graph B for speed #6, Graphs C and D are for speed #10 with the two strobes moving slowly in opposite directions when the correct setting is obtained.





Fig. 83

- G. Place trim band (Fig. 83) on the gear case and motor housing and with the two #6-32 x  $\frac{3}{16}$ " binding head screws, fasten it to the end of the housing. Tuck in all the wire leads and place the end cover on end of machine and secure it with the #6-32 x  $\frac{3}{8}$ " oval head screw (Fig. 84).



Fig. 84

- H. With the end cover on the machine, test the speeds again to be sure no change took place in the control plate. With mixer working perfectly, place bowl on the bowl screw cap. Place flat beater on the agitator shaft. Lower the head so beater is at bottom of bowl. There should be approximately  $\frac{1}{16}$ " clearance between bowl and beater. If beater is too close to bowl, turn in the adjusting screw and out if it is too far away (Fig. 85). Mixer is now ready for operation.



Fig. 85

## SECTION 7

### REPAIRS TO MODEL K5SS & KSMC50 BOWL LIFT ASSEMBLY

- A. The models K45SS & KSM90 and K5SS & KSMC50 KitchenAid mixers have different type of bowls and are different in size. The K45SS & KSM90 bowl is held stationary by mechanical means at bottom of the pedestal; whereas, the K5SS and KSMC50 bowl slides up and down on gibs on the front of the pedestal. On the model K5SS & KSMC50, the gear case and motor housing is stationary making it necessary to move the bowl.

B. Should the mixer be tipped over or knocked off the table or counter, the bowl support assembly may be broken. To repair, it is necessary to replace the bowl support.

C. To replace the bowl support, remove the four  $\frac{5}{16}$ "-18 x  $\frac{3}{4}$ " round head screws (Fig. 86) and lift the gear case and motor housing off the column (Fig. 87).



Fig. 86



Fig. 87



Fig. 88

E. Remove the two #10-24 x  $\frac{1}{2}$ " flat head screws (Fig. 89) and pull out the bowl support down and off the column (Fig. 90).



Fig. 89



Fig. 90

D. With the bowl lift assembly on the bench, lay it on its back and remove the four  $\frac{5}{16}$ "-18 x  $\frac{3}{4}$ " round head screws (Fig. 88) and lift the column off the base.



- F. Examine the bowl lift arm. This part is held on the bowl lift handle with a tapered pin. If the arm is cracked at the pin hole, replace it. If there is any fault in the column, replace it at the same time.
- G. To install a new bowl lift arm, drive out the taper pin (Fig. 91). Drive from the small end of the pin. With pin out, pull out the bowl lift handle (Fig. 92). The bowl lift arm can now be removed along with the bowl lift mechanism.



Fig. 91

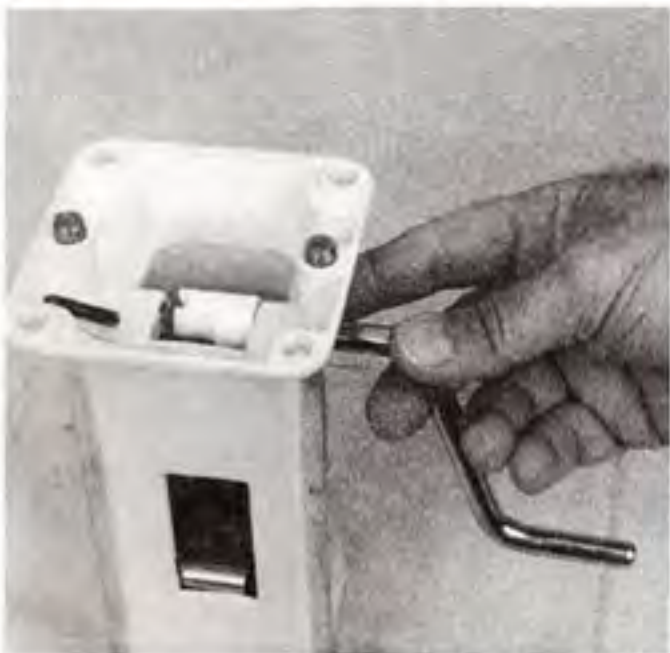

Fig. 92

- H. Hold the bowl lift arm with large end of the tapered hole up. Start bowl lift handle into the arm. Hold handle so it is pointing down. Push it all the way through the arm and into the bearing hole in the column. Place small end of the tapered pin in the arm and drive it through the lift handle (Fig. 93). Be sure the pin is very tight.



Fig. 93

- I. Slide the new bowl support assembly on the column (Fig. 90). Place the bowl lift bracket in place and screw in the two #10-24 x 1/2" flat head screws. These screws must be very tight. Check the castle nut so that the tension will be great enough to snap the rod into the arm and hold it there (Fig. 94).



Fig. 94

- J. Place the base on the bottom of the column and screw in the four  $\frac{5}{16}$ "-18 x  $\frac{3}{4}$ " round head screws (Fig. 95). Be sure these screws are very tight to prevent shaking loose (70 to 90 in. lbs.).



Fig. 95

- K. If the base feet are worn, replace them. To replace the feet, unscrew the #8-32 x  $\frac{1}{2}$ " round head screws and remove the old feet (Fig. 96). Place the screws in the new feet and screw the feet to the base. Do not tighten so much as to push screw through the rubber.



Fig. 96

- L. The bowl spring latch must be installed to complete the repairs to the bowl support. The function of this latch is to hold down the rear of the bowl. Hold latch with bent spring and insert the two #10-24 x  $\frac{1}{4}$ " round head screws into the column and turn the screws in tight (Fig. 97).



Fig. 97

- M. Place the gear case and motor housing on the column and screw in the four  $\frac{5}{16}$ "-18 x  $\frac{3}{4}$ " round head screws (Fig. 98). These screws must be tight (70 to 90 in. lbs.). Mixer is now ready for operation.



Fig. 98

To attach the bowl to the support, place bowl support tabs on bowl over locating pins (Fig. 99) and press down on back of bowl until bowl pin on back of bowl snaps into spring latch.



Fig. 99



## SECTION 8

### TROUBLESHOOTING THE K5SS BOWL LIFT ASSEMBLY

- A. If the beater rubs the bottom of the bowl, it can be corrected by tapping the yoke arm with a mallet. There should be  $\frac{1}{16}$ " clearance between bottom of bowl and end of the beater.
- B. Too much clearance between bowl and beater, tap enough so that there is  $\frac{1}{16}$ " clearance between bowl and beater.
- C. If the bowl and beater are too far apart, use a mallet and tap both sides of the yoke arm up evenly until the  $\frac{1}{16}$ " beater to bowl clearance is met.

*NOTE:  $\frac{1}{16}$ " can be determined by dropping a dime in the bowl. The flat beater should just "touch" the coin as beater rotates.*

- D. Bowl rocks on the bowl support. This is caused by a broken bowl spring latch. Remove the two screws and place a new latch in position. Screw in the two screws tightly.
- E. If bowl retaining pins are worn, the bowl will move on the pins and beater will hit sides of the bowl. To replace the pins, twist and pull at the same time. They are not difficult to remove. To place new pins in the bowl support, place pins in the holes, support the end of the arms with a heavy object and drive the pins down gently. Be very careful not to bend the arms of the bowl support.

The following table lists the more common troubles in the repair of models K45SS and K5SS KitchenAid mixers. The trouble and possible cause are given with the method used for remedy. For more detailed instructions on how to correct a fault, refer to the index.

TROUBLE	POSSIBLE CAUSE	REMEDY
Switch lever clicks, but mixer will not run or buzz.	Open electrical circuit.	Faulty plug. Faulty attachment cord. Faulty speed control plate. Wire lead loose from brushholder. Bad connection between field and cord. Open circuited armature. Open circuited field. Faulty switch—ON/OFF. Bad phase control. Dirty contacts. Brush orientation.
Mixer will not shut off with switch lever.	ON/OFF switch not correctly adjusted with switch control link.	Check switch control link.
Bowl not held firmly on base of mixer.	Loose clamp disc screws.	Tighten the screws.
	Bent screw cap.	Replace screw cap. If none available, bend the four lugs or lips back into position.
Beater strikes bowl or too much clearance.	Adjusting screw at rear of pedestal improperly set.	Turn the adjusting screw slightly to right or left to adjust clearance. Clearance should be $\frac{1}{16}$ ".
Planetary turns, but beater does not revolve.	Pinion gear drive pin broken.	Remove planetary and take off the pinion gear. Replace the drive pin.
Mixer runs with raspy, bumpy noise at planetary.	Gear case cover internal gear teeth worn or broken.	Remove the planetary and gear case cover. The complete gear case cover assembly must be replaced.
Mixer runs with bad vibration, rumbling noise and goes to higher speeds.	Faulty governor. Control plate contacts not going closed.	Replace governor. Adjust control plate.
	Bad phase control.	Replace phase control.
Mixer runs on low speed, but has no power.	Bad electrical connections.	Check the connections to the control plate. Repair any loose connections.
	If the mixer still has no power after cleaning the contacts and checking the connections, the contacts are faulty.	Replace the control plate assembly.

TROUBLE	POSSIBLE CAUSE	REMEDY
Mixer has no power on low speed, but OK on high.	Low speed adjustment improperly set.	Remove end cover and plug in cord. The planetary should revolve at about 60 RPM at the stir position. To adjust, turn in the control plate adjusting screws an equal amount.
Repeated worm gear failures.	Galled attachment gear.	Replace gear.
Mixer has no power on low speed, but OK on high. (cont.)	Faulty governor.	Turn the switch knob to #10 position and hold out the control plate as far as possible. Turn the knob to OFF and observe the governor as it recedes when the armature slows down. The outer plate must move in smoothly, without sticking, until almost touching middle plate. If governor is faulty, replace with new one.
Mixer runs only on high speed.	Control plate spring unhooked.	Remove trim and end cover and check control plate spring. If unhooked, attach to bottom of the control plate and squeeze the spring end.
	Phase control shorted.	With the line cord disconnected pull the t-bar contacts to open and insert a piece of paper between them so they cannot close. Reapply power—the mixer should just run or buzz trying to run. If it operates at full speed, the phase control is defective.
	Wires wrong.	Check wiring.
Mixer runs with jerky clattering noise on low speed.	Loose connections on control board.	Check connections on control board to make certain they are not loose.
Tight shim on vertical shaft between planetary and lower gear case (see V, Section 4).	Tight bearing.	First check the bearing in the planetary beater shaft. If the bearing can be easily moved with a back-and-forth twisting effort, it is satisfactory. If it binds, remove the planetary and recheck the mixer. If the mixer still uses excessive watts, it must be disassembled and the other bearings checked.
Loud rumbling or howling noise.	Worn spherical bearing on end of armature shaft.	Remove bearing bracket and replace.
	Worn thrust ball bearing.	Remove the gears from the gear case and the armature from the motor housing, then replace the thrust ball bearing.
Mixer runs, but will not come up to high speed. Has power, but labors and uses excessive watts.	Tight bearing, if no smoke is apparent.	First check the bearing in the planetary beater shaft. If the bearing can be easily moved with a back-and-forth twisting effort, it is satisfactory. If it binds, remove the planetary and recheck the mixer. If the mixer still uses excessive watts, it must be disassembled and the other bearings checked.



TROUBLE	POSSIBLE CAUSE	REMEDY
Armature shimmed too tight (see item J, Section 3).	Burned out armature, if mixer smokes.	Disassemble the motor and replace the armature assembly.
Mixer will not shut off with switch knob.	Switch not correctly adjusted with control link and cam assembly.	Bend the fixed contact until switch arm properly engages.
Switch knob clicks, but mixer will not run or buzz.	Open electrical circuit.	Progressively disassemble the speed control mechanism and motor, and perform the following checks until the open circuit is found: Faulty plug. Faulty attachment cord. Bad connection in speed control mechanism. Faulty speed control plate. Wire lead clip detached from brush holder. Bad connection between field and cord. Open-circuited armature. Open-circuited field. Correct brush orientation.
Electrical shock to operator.	Bare lead touching inside of housing.	Pull the plug, turn the switch on and check for a ground with a test lamp. Touch one prong of the test lamp to a prong of the plug and the other prong to an unpainted spot on the housing. If the lamp lights the mixer is grounded. Examine all the wiring in the order of its accessibility, until the grounded lead is found. If mixer has radio interference, condenser wired between stator screw and power cord, remove and discard.
Mixer will not run although switch clicks, motor buzzes and smokes.	Frozen bearing.	Examine all the bearings in the order of their accessibility, until the frozen bearing is found.
Bad sparking at contact points or burned contacts on switch.	Wired wrong.	Check wiring.
	Faulty phase control	Remove and replace.
Bad sparking at motor brushes.	Worn motor brushes.	Remove brushes and check that they are not worn to less than $\frac{1}{16}$ ". Replace with new brushes if excessively worn (HC-34 or HC-38).
	Rough commutator.	Remove and replace armature. Check brushes for wear.
	Faulty armature or shorted motor field.	Disassemble and check motor.
Mixer runs on high speed only.	Phase control.	Replace phase control.

