



Propane Lanterns
Lanternes à propane
Lámparas de Propano

5177 Series

INSTASTART™ Electronic Ignition
Allumage électronique
Encendido electrónico

Patent Pending
Brevet en instance
Patente Pendientes

Instructions for use
Notice d'emploi
Instrucciones de uso

© 2005 The Coleman Company, Inc.
www.coleman.com

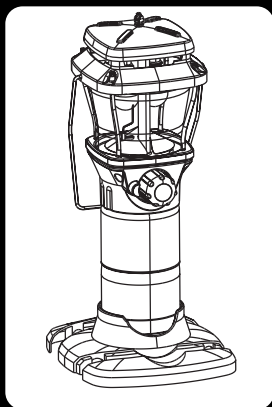

ANSI Z21.73b - CSA 11.1b (2002)
Camp Light
Lanterne de camping
Lámpara para Campamento

IMPORTANT

Read this manual carefully before assembling, using or servicing these lanterns. Keep this manual for future reference. If you have questions about assembly, operation, servicing or repair of these lanterns, please call Coleman at 1-800-835-3278 or TDD: 316-832-8707. In Canada call 1-800-387-6161.

IMPORTANT

Lisez attentivement ce manuel avant d'assembler, d'utiliser ou de réparer ces lanternes et gardez-le pour référence ultérieure. Pour toute question en ce qui concerne l'assemblage, le fonctionnement, l'entretien ou la réparation, appelez Coleman au 1 800 835-3278 ou ATS 316-832-8707 aux États-Unis et au 1 800 387-6161 au Canada.

IMPORTANTE

Lea este manual cuidadosamente antes del ensamblaje y el uso o el servicio de las lámparas. Guarde este manual para uso de referencia en el futuro. Si usted tiene preguntas acerca del ensamblaje, funcionamiento, servicio o reparación de estas lámparas, por favor llame a Coleman al 1-800-835-3278 o TDD: 316-832-8707. En Canadá llame al 1-800-387-6161.

FOR YOUR SAFETY

If you smell gas:

1. Do not attempt to light appliance.
2. Extinguish any open flame.
3. Disconnect from fuel supply.

FOR YOUR SAFETY



Do not store or use gasoline or other liquids with flammable vapors in the vicinity of this or any other appliance.

! DANGER



CARBON MONOXIDE HAZARD

- This appliance can produce carbon monoxide which has no odor.
- Using it in an enclosed space can kill you.
- Never use this appliance in an enclosed space such as a camper, tent, car or home.

This manual contains important information about the assembly, operation and maintenance of these propane lanterns. General safety information is presented on this page and is also located throughout these instructions. Particular attention should be paid to information accompanied by the safety alert symbol "  DANGER", "  WARNING", "  CAUTION".

Keep this manual for future reference and to educate new users of this product. This manual should be read in conjunction with the labeling on the product.

Safety precautions are essential when any mechanical or propane fueled equipment is involved. These precautions are necessary when using, storing, and servicing. Using this equipment with the respect and caution demanded will reduce the possibilities of personal injury or property damage.

The following symbols shown below are used extensively throughout these instructions. Always heed these precautions, as they are essential when using any mechanical or propane fueled equipment.

! DANGER

DANGER indicates an imminently hazardous situation which, if not avoided, will result in death or serious injury.

! WARNING

WARNING indicates a potentially hazardous situation which, if not avoided, could result in death or serious injury.

! CAUTION

CAUTION indicates a potentially hazardous situation which, if not avoided, may result in minor or moderate personal injury, or property damage.

! DANGER

Failure to comply with the precautions and instructions provided with these lanterns can result in death, serious bodily injury and property loss or damage from hazards of fire, explosion, burn, asphyxiation, and/or carbon monoxide poisoning.

Only persons who can understand and follow the instructions should use or service these lanterns.

If you need assistance or information such as an instruction manual or labels, contact The Coleman Company, Inc.

CALIFORNIA PROPOSITION 65:

WARNING: This fuel, and byproducts of combustion of this fuel, contain chemicals known to the state of California to cause cancer, birth defects, or other reproductive harm.

WARNING

- This product is fueled by propane gas. Propane gas is invisible, odorless, and flammable. An odorant is normally added to help detect leaks and can be described as a "rotten egg" smell. The odorant can fade over time so leaking gas is not always detectable by smell alone.
- Propane gas is heavier than air and leaking propane will sink to the lowest level possible. It can ignite by ignition sources including matches, lighters, sparks or open flames of any kind many feet away from the original leak. Use only propane gas set up for vapor withdrawal.
- Propane gas should be stored or used in compliance with local ordinances and codes or with ANSI/NFPA 58. Turn off propane when not in use.

DANGER



• EXPLOSION - FIRE HAZARD

- Never store propane near high heat, open flames, pilot lights, direct sunlight, other ignition sources or where temperatures exceed 120 degrees F (49°C).
- Propane is heavier than air and can accumulate in low places. If you smell gas, leave the area immediately.
- Never install or remove propane tank while lantern is lighted, near flame, pilot lights, other ignition sources or while lantern is hot to touch.
- During operation, this product can be a source of ignition. Never use the lantern in spaces that contain or may contain volatile or airborne combustibles, or products such as gasoline, solvents, paint thinner, dust particles or unknown chemicals. Minimum clearances from combustible materials: 12 inches from the sides and 48 inches from the top.
- Do not obstruct the flow of combustion or ventilation air.
- Proper lantern operation produces a bright white light.

WARNING

Not for home or recreational vehicle use.

We cannot foresee every use which may be made of our products.

Check with your local fire safety authority if you have questions about use.

Other standards govern the use of fuel gases and heat producing products for specific uses. Your local authorities can advise you about these.

- Never refill disposable cylinders.
- Use the preset regulator that came with the lantern. Do not attempt to adjust.
- Use only Coleman[®] accessories or parts. During lantern set-up, check all fittings for leaks using soapy water. Never use a flame.

WARNING



• BURN HAZARD

- Never leave lantern unattended when hot or in use.
- Keep out of reach of children.

DANGER



• CARBON MONOXIDE HAZARD

- This lantern is a combustion appliance. All combustion appliances produce carbon monoxide (CO) during the combustion process. This product is designed to produce extremely minute, non-hazardous amounts of CO if used and maintained in accordance with all warnings and instructions. Do not block air flow into or out of the lantern.
- Carbon Monoxide (CO) poisoning produces flu-like symptoms, watery eyes, headaches, dizziness, fatigue and possibly death. You can't see it and you can't smell it. It's an invisible killer. If these symptoms are present during operation of this product **get fresh air immediately!**
- **For outdoor use only.**
- **Never use inside house, camper, tent, vehicle or other unventilated or enclosed areas. This lantern consumes air (oxygen). Do not use in unventilated or enclosed areas to avoid endangering your life.**

CAUTION

• SERVICE SAFETY

- Use only propane set up for vapor withdrawal.
- Keep all connections and fittings clean. Inspect propane cylinder and lantern propane connections for damage before attaching.
- During set up, **CHECK FOR LEAKS** in one or more ways: Apply soapy water to connections. **Look** for bubbles. **Listen** for hiss of escaping gas. **Feel** for extreme cold. **Smell** for rotten egg odor. Never use a flame. **Do not use if leaking.**
- Use as a lighting appliance only. Never alter in any way or use with any device or part not expressly approved by Coleman.
- Never use as a space heater.
- Always use in upright position. Protect cylinder from excess heat.

Technical Characteristics

Input: 3,200 BTU/h

Category: Pressure regulated propane

Fuel: 16.4 oz. disposable propane cylinders

Regulator: 5154

To Set Up

DANGER



• CARBON MONOXIDE HAZARD

- For outdoor use only.
- Never use inside house, camper, tent, vehicle or other unventilated or enclosed areas. This lantern consumes air (oxygen). Do not use in unventilated or enclosed areas to avoid endangering your life.

■ Remove lantern parts from package.

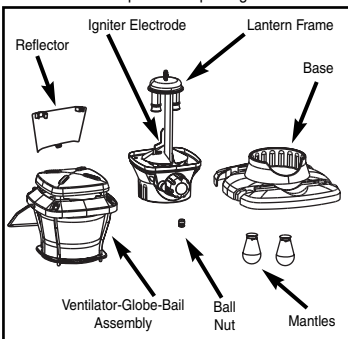

- Always use genuine Coleman® #21 size mantles. If using Insta-Clip® II tabbed mantles, follow the instructions on the mantle package.
- If using tie style mantles, tie mantles around grooves in burner. (Fig. 1)
- Distribute folds on mantle evenly. Cut off surplus string 1/4" (0.6cm) from knot. (Fig. 2)
- For INSTASTART™ electronic ignition lanterns, be careful that mantle does not snag on electrode.

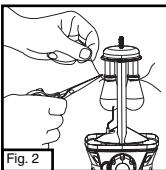
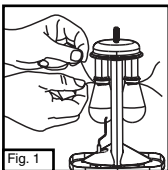

- Light bottom of mantle evenly. Burn until nothing but white ash remains. Once the mantle has been burned, it is very fragile. Be careful not to touch it with finger or match. (Fig. 3, 4)

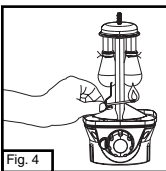
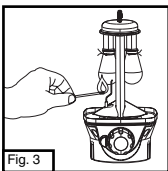

- Complete assembly. (Fig. 5, 6)

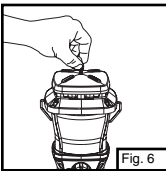
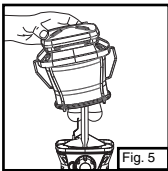

■ **Note:** Use Coleman 16.4 oz. disposable propane cylinders. The LP-gas cylinder(s) used with lanterns must be constructed and marked in accordance with the specifications for LP-gas cylinders of the U.S. Department of Transportation or Transport Canada, CAN/CSA B339.

- Take lantern outdoors away from ignition sources.
- Turn fuel valve off. (Fig. 7)

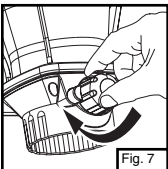

- Remove protective cap from top of propane cylinder. Save cap for use in storing. (Fig. 8)

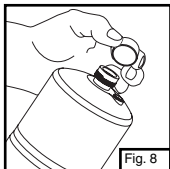

⚠ DANGER



• EXPLOSION - FIRE HAZARD

- Propane is heavier than air and can accumulate in low places. If you smell gas, leave the area immediately.
- Always attach or detach propane source outdoors; never while lantern is lighted, near flame, pilot lights, other ignition sources or while lantern is hot to touch.
- Always light & use lantern outdoors.
- This lantern must not be exposed to flammable vapors or liquids during lighting.
- This lantern is red hot during use and can ignite flammables too close to the mantles. Keep flammables at least 12 inches from the sides and 48 inches from the top of the lantern. Keep gasoline and other flammable liquids and vapors well away from lantern.

- Always extend base before use. (Fig. 9)

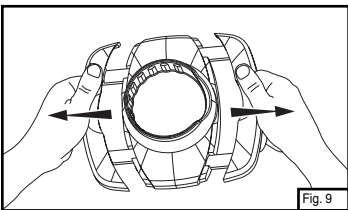

- Screw propane cylinder into lantern. Take care not to cross-thread. Hand tighten only. (Fig. 10)

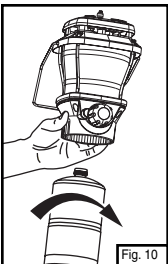

- Set lantern into base. (Fig. 11)

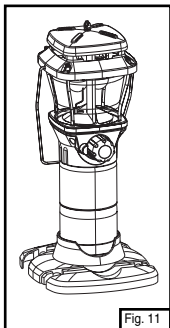

To Light

⚠ WARNING

If you smell gas:

1. Do not attempt to light appliance.
2. Extinguish any open flame.
3. Disconnect from fuel supply.
4. Call 1-800-835-3278.

⚠ WARNING

- Replace any mantle with a hole in it. A hole can cause lantern to overheat and create a hazard. Never operate lantern without heat shield.

■ Assemble reflector to back of lantern. Position the reflector clips onto the center of the two back rails and slide either upward into the reflecting position or downward into the storage position. (Fig. 12)

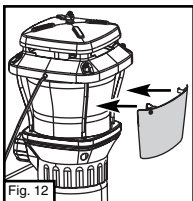

Fig. 12

■ Reflecting position. Bottom tab rests inside lantern frame. (Fig. 13)

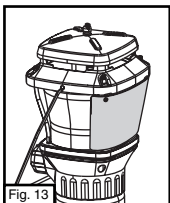

Fig. 13

■ Storage position. Reflector hangs from back rails. (Fig. 14)

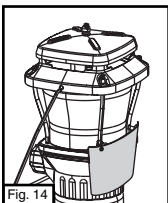

Fig. 14

⚠ CAUTION

• SERVICE SAFETY

- Keep all connections and fittings clean. Inspect propane cylinder and lantern propane connections for damage before attaching.
- During set up, check all connections and fittings for leaks using soapy water. Bubbles indicate a leak. Never use a flame.

Match Light Lantern

■ Push lighted match through lighting hole, hold near mantle and open fuel valve fully. (Fig. 15)

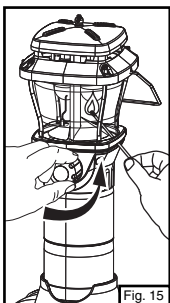

Fig. 15

INSTASTART™ Electronic Ignition Lantern

■ Open burner valve and repeatedly push igniter button and ignite the mantles. (Fig. 16)

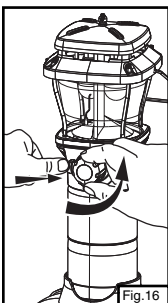

Fig. 16

⚠ WARNING



• BURN HAZARD

- Never leave lantern unattended when hot or in use.
- Keep out of reach of children.

NOTE: If lantern does not light, repeat above step. If the lantern does not light after several attempts, check for a spark while clicking the igniter. If no spark is present, check the electrode gap. The gap should be about .2" (5 mm). Carefully bend electrode to set gap. If the lantern is wet due to rain, high humidity, etc., the electrode may not spark. Use lighting procedure for match light version lanterns. (Fig. 17)

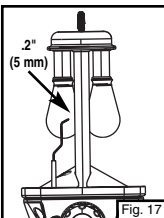

Fig. 17

■ Brightness may be adjusted with fuel valve. (Fig. 18)

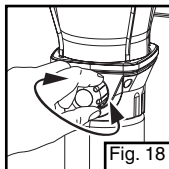

Fig. 18

To Turn Off

■ Turn fuel valve off. (Fig. 19)

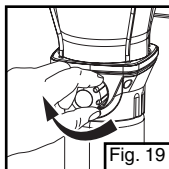

Fig. 19

To Store

- Make sure lantern is cool.
- Move lantern away from flame (including pilot lights) and other ignition sources.
- Remove propane cylinder from lantern. (Fig. 20)
- Replace protective cap on propane cylinder.

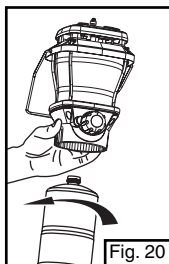

Fig. 20

■ Lantern can be placed in base for secure storage. (Fig. 21)

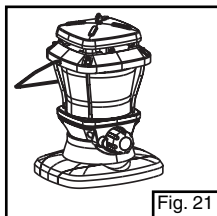

Fig. 21

⚠ DANGER



• EXPLOSION - FIRE HAZARD

- Never store propane near high heat, open flames, pilot lights, direct sunlight, other ignition sources or where temperatures exceed 120 degrees F (49°C).
- The cylinder must be disconnected when the lantern is in storage.

Things You Should Know

1. It is unsafe and illegal in some places to store or use liquid propane cylinders of greater than 1.14 kg (2.5 lbs.) water capacity (approximately 465g [1 lb.] propane) in occupied enclosures.
2. Always have a spare set of Coleman® Mantles. Once burned, a mantle is fragile and can be damaged if touched or dropped.
3. Wipe lantern clean with soft cloth and mild dish detergent. Do not use abrasives.
4. The usual storage areas for camping and picnic equipment are the basement, attic, or garage. To avoid the accumulation of dust, cobwebs, etc., that is common in these storage areas, place your lantern in a plastic bag and seal it with a rubber band.
5. During operation, carry the lantern using the bail.
6. If your lantern burns with a yellow smokey flame, check the burner and air tube for spider webs.
7. For repair service call one of the numbers listed on the front cover for location of your nearest Coleman Service Center. If lantern must be mailed to Service Center, attach to the product a tag that includes your name, address, daytime telephone number and a description of problem. Remove globe and ventilator to prevent breakage. Do NOT send propane cylinder. Carefully package the product and send either by **courier** or **insured mail** with shipping and **insurance** prepaid to:

For products purchased in the United States:

The Coleman Company, Inc.

3600 N. Hydraulic • Wichita, KS 67219 U.S.A.
1-800-835-3278 • TDD: 316-832-8707

For products purchased in Canada:

Sunbeam Corporation (Canada) Limited
5975 Falbourne Street • Mississauga, Ontario
Canada • L5R 3V8 • 1 800 387-6161

8. If not completely satisfied with the performance of this product, please call one of the numbers listed on the cover of this manual.

www.coleman.com

Warranty

Limited Five Year Warranty

The Coleman Company, Inc. ("Coleman") warrants that for a period of five years from the date of original retail purchase, this product will be free from defects in material and workmanship. Coleman, at its option, will repair or replace this product or any component of the product found to be defective during the warranty period. Replacement will be made with a new or remanufactured product or component. If the product is no longer available, replacement may be made with a similar product of equal or greater value. This is your exclusive warranty.

This warranty is valid for the original retail purchaser from the date of initial retail purchase and is not transferable. Keep the original sales receipt. Proof of purchase is required to obtain warranty performance. Coleman dealers, service centers, or retail stores selling Coleman® products do not have the right to alter, modify or in any way change the terms and conditions of this warranty.

What This Warranty Does Not Cover

This warranty does not cover normal wear of parts, parts that are not genuine Coleman® parts, or damage resulting from any of the following: negligent use or misuse of the product; use on improper voltage or current; commercial use of the product; use contrary to the operating instructions; disassembly, repair or alteration by anyone other than Coleman or an authorized service center. Further, the warranty does not cover Acts of God, such as fire, flood, hurricanes and tornadoes. Warranty void if damage to product results from the use of a part other than a genuine Coleman® part.

COLEMAN SHALL NOT BE LIABLE FOR DEFECTS THAT ARE CAUSED BY THE USE OF UNAUTHORIZED PARTS OR SERVICE. COLEMAN SHALL NOT BE LIABLE FOR ANY INCIDENTAL OR CONSEQUENTIAL DAMAGES CAUSED BY THE BREACH OF ANY EXPRESS OR IMPLIED WARRANTY OR CONDITIONS. EXCEPT TO THE EXTENT PROHIBITED BY APPLICABLE LAW, ANY IMPLIED WARRANTY OF MERCHANTABILITY OR FITNESS FOR A PARTICULAR PURPOSE IS LIMITED IN DURATION TO THE DURATION OF THE ABOVE WARRANTY OR CONDITIONS. SOME STATES, PROVINCES, OR JURISDICTIONS DO NOT ALLOW THE EXCLUSION OR LIMITATION OF INCIDENTAL OR CONSEQUENTIAL DAMAGES OR LIMITATIONS ON HOW LONG AN IMPLIED WARRANTY LASTS, SO THE ABOVE LIMITATIONS OR EXCLUSION MAY NOT APPLY TO YOU. THIS WARRANTY GIVES YOU SPECIFIC LEGAL RIGHTS, AND YOU MAY ALSO HAVE OTHER RIGHTS THAT VARY FROM STATE TO STATE OR PROVINCE TO PROVINCE.

How to Obtain Warranty Service

Take the product to an authorized Coleman service center. You can find the nearest authorized Coleman service center by visiting www.coleman.com or calling 1-800-835-3278 or TDD 316-832-8707 in the United States or 1 800 387-6161 in Canada. If a service center is not conveniently located, attach to the product a tag that includes your name, address, daytime telephone number and description of the problem. Include a copy of the original sales receipt. Carefully package the product and send either by **courier** or **insured mail** with shipping and **insurance** prepaid to:

For products purchased in the United States:

The Coleman Company, Inc.
3600 North Hydraulic
Wichita, KS 67219

For products purchased in Canada:

Sunbeam Corporation (Canada) Limited
5975 Falbourne Street
Mississauga, Ontario
Canada L5R 3V8

The costs of transporting the product to Coleman or an authorized service center for warranty service is the responsibility of the purchaser.

Do not mail products with fuel in tanks, or with disposable propane cylinders. Remove glass globes from lanterns and wrap separately.

DO NOT RETURN THIS PRODUCT TO THE PLACE OF PURCHASE.

If you have any questions regarding this warranty please call 1-800-835-3278 or TDD 316-832-8707 in the United States or 1 800 387-6161 in Canada.

Parts List

Item	Part No.	Description
1	220A4411	Ball Nut
2	5177-4801	Ventilator
3	R5177-043C	Globe
4	#21 Size	Mantles (String tie or Insta-Clip® II)
5	5177A1011	Rail w/Hardware (1 pk.)
6	5177-5951	Frame/Globe Spring Assy.
7	5177-1381	Bail
8	5177A1491	Knob w/screw
9	5177A5401	Base Assembly
10	5177-1151	Heat Shield
11	5177-5001	Reflector Assy.

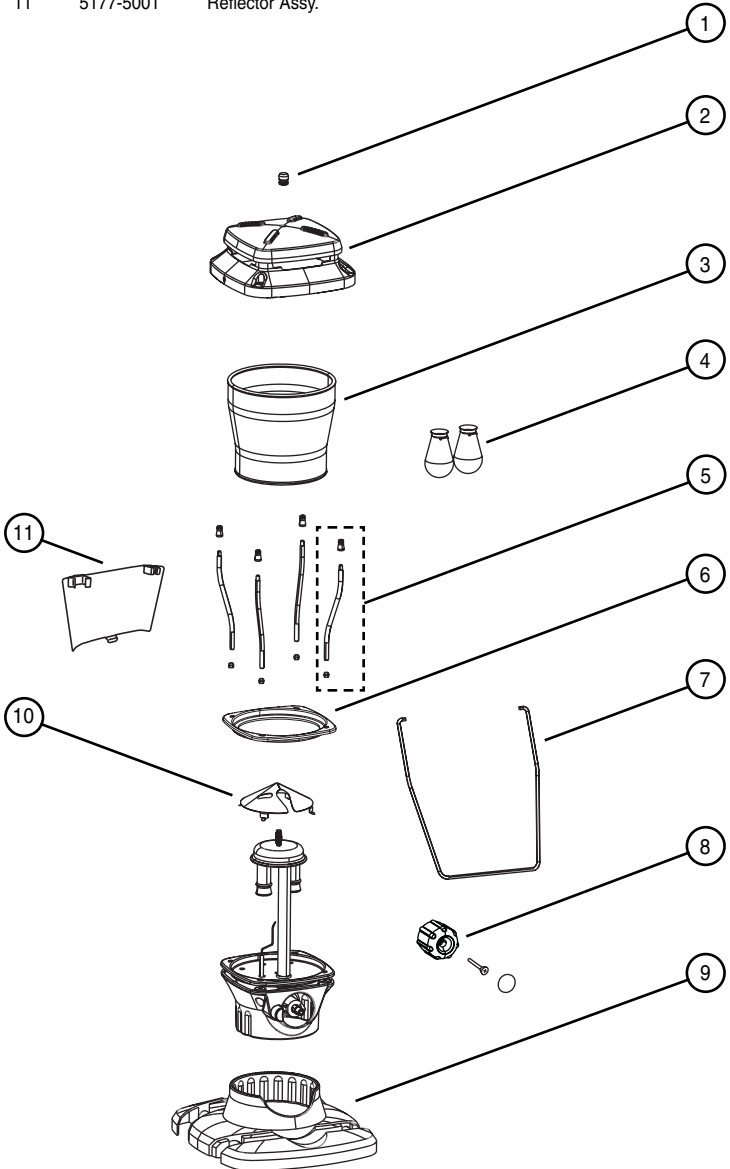





The Coleman Company, Inc. • 3600 N. Hydraulic • Wichita, KS 67219 U.S.A.
1-800-835-3278 • TDD: 316-832-8707

Sunbeam Corporation (Canada) Limited • 5975 Falbourne Street
Mississauga, Ontario, Canada L5R 3V8 • 1 800 387-6161

© 2005 The Coleman Company, Inc. All rights reserved. Coleman®,  and InstaClip® are registered trademarks and INSTASTART™ is a trademark of The Coleman Company, Inc.

© 2005 The Coleman Company, Inc. Tous droits réservés. Coleman®,  et InstaClip® sont des marques déposées alors que INSTASTART™ est une marque de commerce de The Coleman Company, Inc.

© 2005 The Coleman Company, Inc. Todos los derechos reservados. Coleman®,  y InstaClip® son marcas registradas y INSTASTART™ es una marca de la compañía The Coleman Company, Inc.

www.coleman.com