

# Owner's Manual



Model,                    116.25614  
                                  116.25615



**CAUTION:**  
Read and follow all  
safety and operating  
instructions before first  
use of this product.

## TABLE OF CONTENTS

<b>Before Using Your New Vacuum Cleaner</b> .....	2	<b>Canister Care</b> .....	14
<b>Kenmore Vacuum Cleaner Warranty</b> .....	3	Bag Changing .....	14
<b>Important Safety Instructions</b> .....	4	Cleaning Exterior and Attachments .....	15
<b>Parts and Features</b> .....	5-6	Motor Safety Filter Changing .....	15
<b>Assembly Instructions</b> .....	7-8	Exhaust Filter Changing .....	16
<b>Power-Mate Jr.® Storage</b> .....	8	<b>Power-Mate® Care</b> .....	17
<b>Operating Instructions</b> .....	9	Belt Changing and Agitator Cleaning ..	17-18
How to Start .....	9	Light Bulb Changing .....	18
Vacuuming Tips .....	10	Agitator Servicing .....	19
Suggested Pile Height Settings .....	11	<b>Troubleshooting</b> .....	20
Attachments .....	11	<b>Requesting Assistance</b>	
Attachment Use Table .....	12	<b>Or Service</b> .....	Back Cover
Performance Features .....	12-13		
How Your Vacuum Cleaner Works .....	14		

## BEFORE USING YOUR NEW VACUUM CLEANER

Please read this guide. It will help you assemble and operate your new Kenmore vacuum cleaner in the safest and most effective way.

For more information about vacuum cleaner care and operation, call your nearest Sears store. You will need the complete model and serial numbers when requesting information. Your vacuum cleaner's model and serial numbers are located on the Model and Serial Number Plate.

Use the space below to record the model number and serial number of your new Kenmore vacuum cleaner.

Model No. \_\_\_\_\_

Serial No. \_\_\_\_\_

Date of Purchase \_\_\_\_\_

Keep this book and your sales check (receipt) in a safe place for future reference.

## KENMORE VACUUM CLEANER WARRANTY

### **One Year Limited Warranty**

When assembled, operated and maintained according to all instructions supplied with the product, if this vacuum cleaner fails due to a defect in material or workmanship within one year from the date of purchase, return it to any Sears store, Sears Parts & Repair Center or other Kenmore outlet for free repair.

If this vacuum cleaner is used for other than private family purposes, this warranty applies for only 90 days from the date of purchase.

**This warranty covers only defects in material and workmanship. Sears will NOT pay for:**

1. Expendable items that can wear out from normal use, including but not limited to filters, belts, light bulbs, and bags.
2. A service technician to instruct the user in correct product assembly, operation or maintenance.
3. A service technician to clean or maintain this product.
4. Damage to or failure of this product if it is not assembled, operated or maintained according to all instructions supplied with the product.
5. Damage to or failure of this product resulting from accident, abuse, misuse or use for other than its intended purpose.
6. Damage to or failure of this product caused by the use of detergents, cleaners, chemicals or utensils other than those recommended in all instructions supplied with the product.
7. Damage to or failure of parts or systems resulting from unauthorized modifications made to this product.

### **Disclaimer of implied warranties; limitation of remedies**

Customer's sole and exclusive remedy under this limited warranty shall be product repair as provided herein. Implied warranties, including warranties of merchantability or fitness for a particular purpose, are limited to one year or the shortest period allowed by law. Sears shall not be liable for incidental or consequential damages. Some states and provinces do not allow the exclusion or limitation of incidental or consequential damages, or limitations on the duration of implied warranties of merchantability or fitness, so these exclusions or limitations may not apply to you.

This warranty applies only while this vacuum cleaner is used in the United States and Canada.

This warranty gives you specific legal rights, and you may also have other rights which vary from state to state.

# IMPORTANT SAFETY INSTRUCTIONS

## WARNING

Your safety is important to us. To reduce the risk of fire, electrical shock, injury to persons or damage when using your vacuum cleaner, follow basic safety precautions including the following:

**Read** all instructions in this manual before assembling or using your vacuum cleaner.

**Use** your vacuum cleaner only as described in this manual. Use only with Sears recommended attachments.

**Disconnect** electrical supply before servicing or cleaning out brush area. Failure to do so could result in electrical shock or brush suddenly starting.

**Do not** leave vacuum cleaner when plugged in. Unplug from outlet when not in use and before servicing.

To reduce the risk of electrical shock – **Do not** use outdoors or on wet surfaces.

**Do not** allow to be used as a toy. Close attention is necessary when used by or near children.

**Do not** use with damaged cord or plug. If vacuum cleaner is not working as it should, has been dropped, damaged, left outdoors, or dropped into water, return it to a Sears Service Center.

**Do not** pull or carry by cord, use cord as a handle, close door on cord, or pull cord around sharp edges or corners. Do not run vacuum cleaner over cord. Keep cord away from heated surfaces.

**Do not** unplug by pulling on cord. To unplug, grasp the plug, not the cord.

**Do not** handle plug or vacuum cleaner with wet hands.

**Do not** put any objects into openings.

**Do not** use with any opening blocked; keep free of dust, lint, hair and anything that may reduce airflow.

**Keep** hair, loose clothing, fingers, and all parts of body away from openings and moving parts.

Turn off all controls before unplugging.

**Use extra care** when cleaning on stairs. Do not put on chairs, tables, etc. Keep on floor.

**Do not** use vacuum cleaner to pick up flammable or combustible liquids (gasoline, cleaning fluids, perfumes, etc.), or use in areas where they may be present. The fumes from these substances can create a fire hazard or explosion.

**Do not** pick up anything that is burning or smoking, such as cigarettes, matches, or hot ashes.

**Do not** use vacuum cleaner without dust bag and/or filters in place.

**Always** change the dust bag after vacuuming carpet cleaners or freshener, powders and fine dust. These products clog the bag, reduce airflow and can cause the bag to burst. Failure to change bag could cause permanent damage to the vacuum cleaner.

**Do not** use the vacuum cleaner to pick up sharp hard objects, small toys, pins, paper clips, etc. They may damage the vacuum cleaner or dust bag.

**Do not** operate vacuum cleaner without the exhaust filter or exhaust filter door in place (if applicable).

**The hose** contains electrical wires. **Do not** use when damaged, cut, or punctured. Replace if cut or worn. **Do not** pick up sharp objects.

**Always** turn off and unplug the vacuum cleaner before connecting or disconnecting either hose, Handi-Mate Jr.® (if applicable), or nozzle.

**Hold plug** when rewinding onto cord reel. **Do not** allow plug to whip when rewinding.

**You** are responsible for making sure that your vacuum cleaner is not used by anyone unable to operate it properly.

## SAVE THESE INSTRUCTIONS

Proper assembly and safe use of your vacuum cleaner are your responsibilities. Your vacuum cleaner is intended for **Household use**. Read this Owner's Manual carefully for important use and safety information. This guide contains safety statements under warning and caution symbols.

## PARTS AND FEATURES

It is important to know your vacuum cleaner's parts and features to ensure its proper and safe use. Review these before using your vacuum cleaner.

Object	Style No.	Part No. in USA	Part No. in Canada
Headlight Bulb	----	20-5240	20-40600
Belt	CB-3	20-5218	20-40118

### Power-Mate®

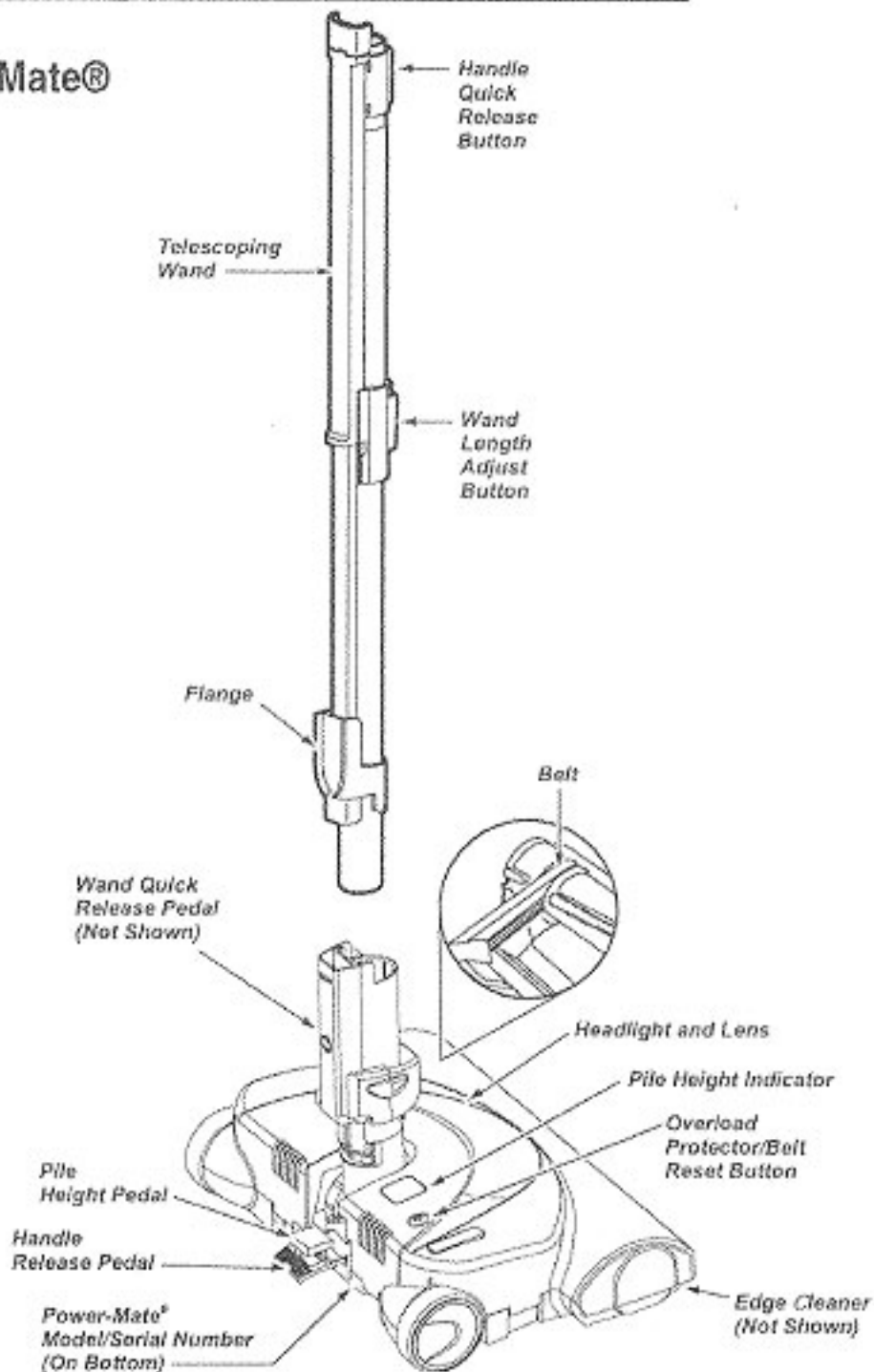

## HOSE

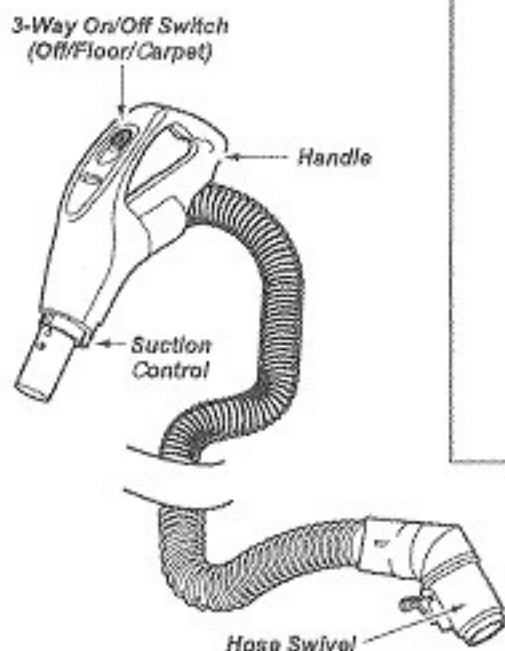

## ATTACHMENTS

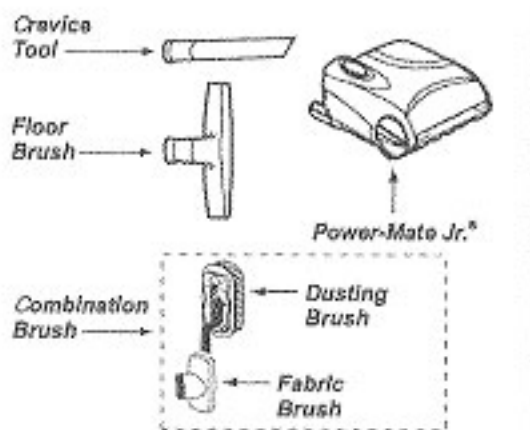

## CANISTER

Object	Style No.	Part No. in USA	Part No. in Canada
Dust Bag	Q	20-50557	20-50410
Exhaust Filter	EF-1	20-86889	20-40324
Motor Safety Filter	CF-1	20-86883	20-40321

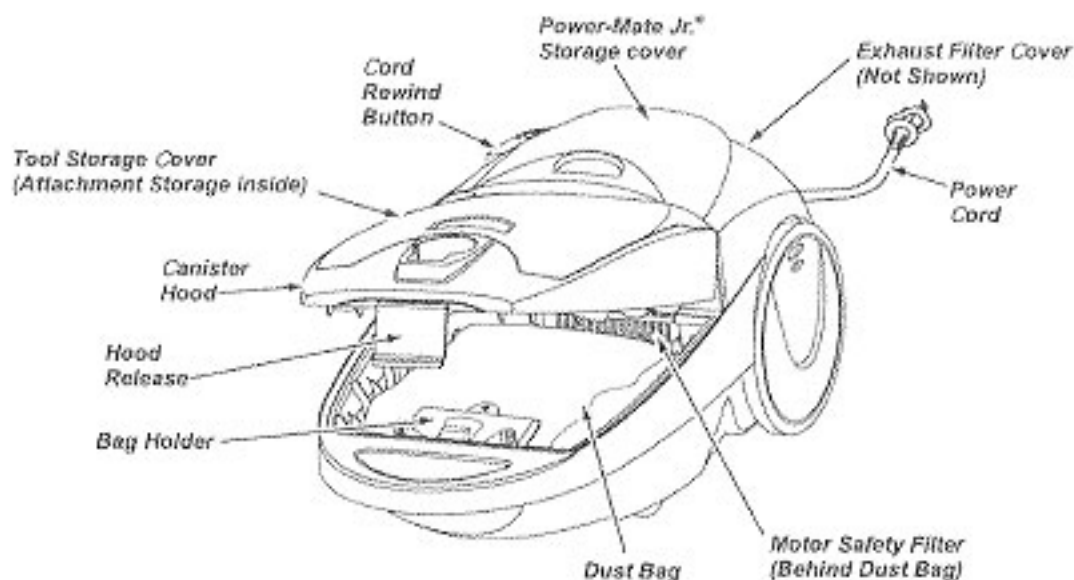



Please pay special attention to these hazard alert boxes, and follow any instructions given. **WARNING** statements alert you to such dangers as fire, electric shock, burns and personal injury. **CAUTION** statements alert you to such dangers as personal injury and/or property damage.

## ASSEMBLY INSTRUCTIONS



### WARNING

#### Electrical Shock Hazard

**DO NOT** plug into electrical supply until assembly is complete. Failure to do so could result in electrical shock or injury.

Before assembling vacuum cleaner, check the **PACKING LIST** on the cover of the separate **REPAIR PARTS LIST**. Use this list to verify that you have received all the components of your new Kenmore vacuum cleaner.

## WAND-TELESCOPING

The wand length is adjustable and requires no assembly. To adjust, simply push down on the wand adjust button and slide the upper wand to the desired height.

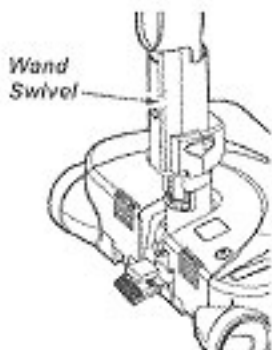
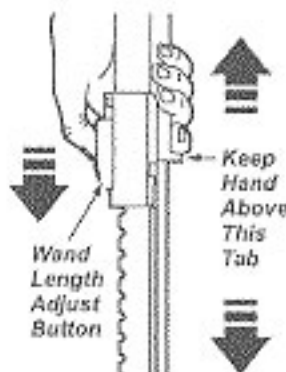

The swivel, located on the Power-Mate®, allows you to turn the handle to the left side to reach farther under low furniture.

When adjusting the wand length you may have to hold the Power-Mate® with your hand or foot.

## POWER-MATE®

Insert wand into Power-Mate® until the wand button snaps into place.

To remove: Step on wand release pedal, then pull up on wands.

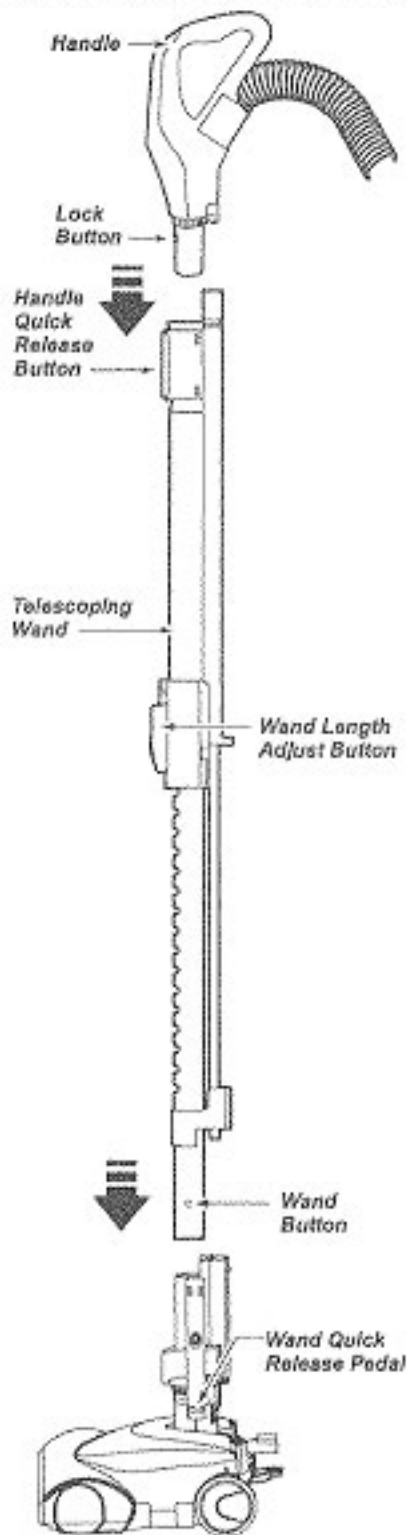

## CANISTER

1. Open the canister hood.
2. Check to see that the dust bag is properly installed. See **BAG CHANGING** for instructions.
3. Check to see that the motor safety filter is properly installed. See **MOTOR SAFETY FILTER CHANGING** for instructions.

## HOOD AND TOOL STORAGE COVER

It is normal for the canister hood and tool storage cover to come off when opened further than needed. Line up the hinge slots, insert the hinges into the slots, and close the hood and tool storage cover to reinstall.

 **CAUTION**

Never open canister hood with the tool storage cover open. This will help to prevent damage from occurring to the canister hood and/or tool storage cover.

## HOSE

1. Line up the hose latch tab and notch in canister hood and insert hose into canister until it snaps in place.

**To remove:** Lift hose latch tab upward and pull up on hose.

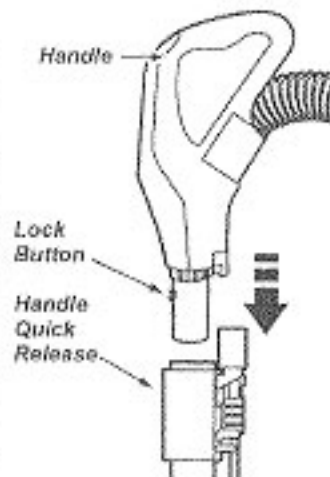

2. Insert handle into wand until lock button snaps in place. **Be sure hose is not twisted.**

**To remove:** Press handle quick release button and pull up on handle.

**To store:** Disconnect hose from wands and canister to prevent stress on hose during storage. Store hose in a loosely coiled position so the hose covering is not stressed.

## POWER-MATE JR.® STORAGE

This canister is equipped with an on-board storage area for a Power-Mate Jr.® attachment.

### To Install:

Open the Power-Mate Jr.® storage cover. Insert the Power-Mate Jr.®, press down into place, and close the lid securely.

### To Remove:

Open the storage cover. Remove Power-Mate Jr.® from the storage area and use as needed (see **ATTACHMENTS** and **ATTACHMENT USE TABLE**).

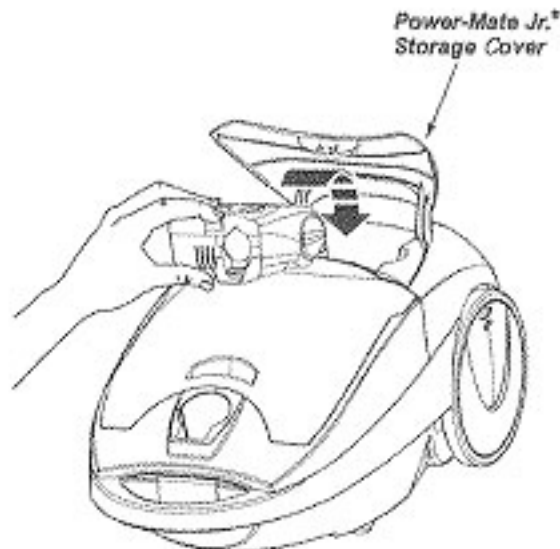



# OPERATING INSTRUCTIONS

## HOW TO START

### **WARNING**

#### Personal Injury and Product Damage Hazard

- **DO NOT** plug in if switch is in ON position. Personal injury or property damage could result.
- The cord moves rapidly when rewinding. Keep children away and provide a clear path when rewinding the cord to prevent personal injury.
- **DO NOT** use outlets above counters. Damage from cord to items in surrounding area could occur.

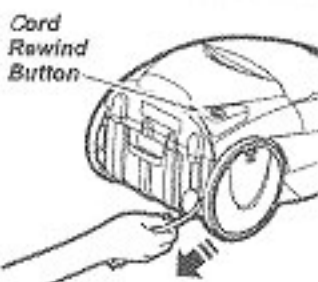

1. Pull cord out of canister to desired length. The cord will not rewind until the cord rewind button is pushed.

**NOTE:** To reduce the risk of electric shock, this vacuum cleaner has a polarized plug; one blade is wider than the other. This plug will fit in a polarized outlet only one way. If the plug does not fit fully in the outlet, reverse the plug. If it still does not fit, contact a qualified electrician to install the proper outlet. Do not change the plug in any way.

2. Plug the polarized power cord into a 120 Volt outlet located near the floor.

**To rewind:** Unplug the vacuum cleaner. Hold the plug while rewinding to prevent damage or injury from the moving cord. Push cord rewind button.

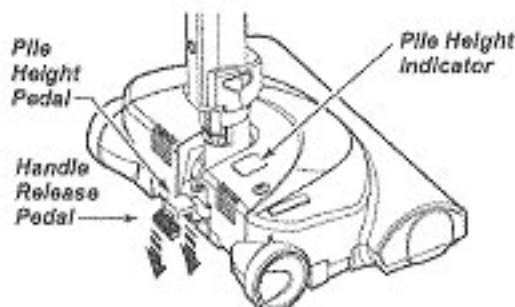
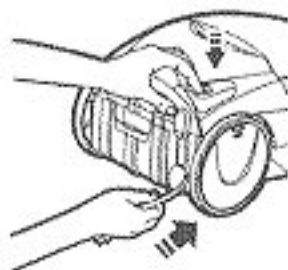

3. Lower wand from upright position by pressing on the handle release pedal.

### **CAUTION**

**DO NOT** leave the Power-Mate® running in one spot in the upright position for any length of time. Damage to carpet may occur.

4. Select a pile height setting by pressing the small pedal on the rear of the Power-Mate®. The pile height setting shows on the indicator. See **SUGGESTED PILE HEIGHT SETTINGS**.

**Attention:** Refer to your carpet manufacturers cleaning recommendations. Some more delicate carpets may require that they be vacuumed with the Power-Mate® agitator turned off to prevent carpet damage.

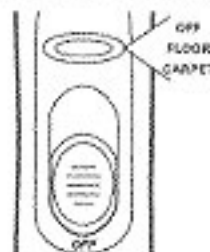

5. Select a switch position on the handle.

**OFF**

**FLOOR** - turns on the canister motor only.

**CARPET** - turns on both the canister and the Power-Mate® motors.

**NOTE** - When this switch is in the **FLOOR** position, the headlight and dirt sensor **DO NOT** function since no electricity flows to the Power-Mate®.

## VACUUMING TIPS

### Suggested sweeping pattern.

For best cleaning action, the Power-Mate® should be pushed straight away from you and pulled straight back. At the end of each pull stroke, the direction of the Power-Mate® should be changed to point into the next section to be cleaned. This pattern should be continued across the carpet with slow, gliding motions.

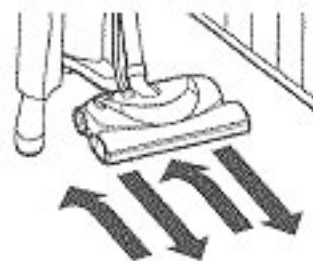

**NOTE:** Fast, jerky strokes do not provide complete cleaning.

The hose swivel allows the hose to turn without moving the canister. This is helpful for cleaning in small areas. Check hose for twisting before pulling canister.

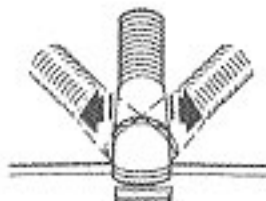

### CAUTION

#### Product Damage Hazard

Use care if the Power-Mate® and wand is left in the upright position as it may tip over easily. Property damage can occur if tipped.

### WARNING

#### Personal Injury and Product Damage Hazard

- DO NOT run over power cord with Power-Mate®. Personal injury or product damage could result.
- DO NOT pull plug from wall by the power cord. If there is damage to the cord or plug, personal injury or property damage could result.

Carpeted stairs need to be vacuumed regularly. For best cleaning results, fully close the suction control.

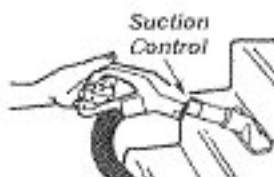

### WARNING

#### Personal Injury Hazard

Use care if canister is placed on stairs. It may fall, causing personal injury or property damage.

### CAUTION

#### Product Damage Hazard

Do not pull on the hose to move the canister from one stair to the next. When finished cleaning in one area use the handle grip on the canister to move the vacuum cleaner to a new location for further cleaning.

The stair grip located on the caster will aid in preventing the canister from slipping when used on stairs (see PERFORMANCE FEATURES).

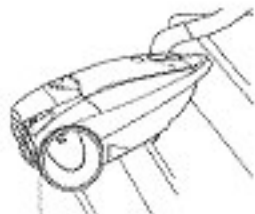

**NOTE:** Be sure the canister is resting securely on the stairs and the caster is in a locked position before using.

For best cleaning results, keep the airflow passage open. Check each assembly area in HOW YOUR VACUUM CLEANER WORKS occasionally for clogs. Unplug from outlet before checking.

## SUGGESTED PILE HEIGHT SETTINGS

For best deep down cleaning, use the XLO setting. However, you may need to raise the height to make some jobs easier, such as scatter rugs and some deep pile carpets, and to prevent the vacuum cleaner from shutting off. Suggested settings are:

HI – Shag, deep pile, or scatter rugs.

MED – Medium to deep pile.

LO – Low to medium pile.

XLO – Most carpets and bare floors.

## ATTACHMENTS

### CAUTION

DO NOT attach or remove handle or wands while vacuum cleaner is ON. This could cause sparking and damage the electrical contacts.

### ATTACHMENTS ON HANDLE

**NOTE:** If the Power-Mate® is attached, turn vacuum cleaner off before removing handle from wands.

1. Press handle quick release button and pull up on handle.

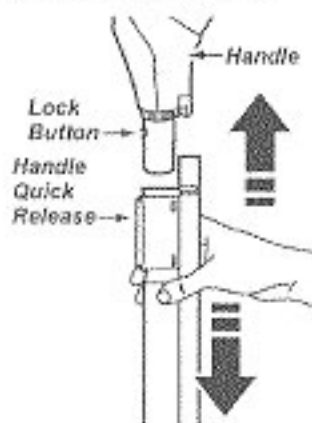

2. Slide attachments firmly on handle as needed. See ATTACHMENT USE TABLE.

#### **NOTE:**

To assemble dusting brush insert the fabric brush into the dusting brush nozzle and press into place.

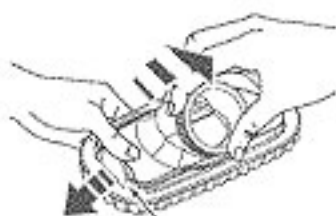

To remove, press latch and lift out.

Latch

### ATTACHMENTS ON WAND

1. To remove wand from Power-Mate®, lock wand in straight-up position.

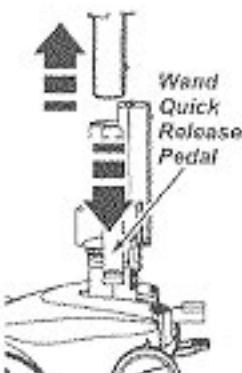
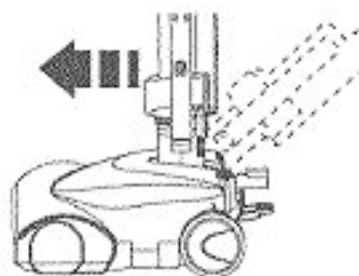







2. Press wand quick release pedal with foot and pull the wand straight up and out of Power-Mate®.

3. Put attachments on wand as needed. See ATTACHMENT USE TABLE.



## ATTACHMENT USE TABLE

ATTACHMENT		CLEANING AREA						
		Furniture <sup>1</sup>	Between Cushions <sup>1</sup>	Drapes <sup>1</sup>	Stairs	Bare Floors	Carpeted Floors/Rugs	Walls
Combination brush	Dusting brush 	✓		✓				✓
	Fabric brush 	✓		✓				
Crevice tool 		✓	✓					
Floor brush 					✓	✓		✓
Power-Mate® 						✓ <sup>2</sup>	✓	
Handi-Mate Jr.® <sup>2</sup> 		✓			✓			
Power-Mate Jr.® <sup>3,4</sup> 		✓			✓			

1. Always clean attachments before using on fabrics.
2. 3-way On/Off switch should be in **FLOOR** position.
3. Some Models; Handi-mate Jr.® and Power-mate Jr.® attachment instructions are included with the products.
4. Power-Mate Jr. can only be used on the hose handle.

## PERFORMANCE FEATURES

### OVERLOAD PROTECTOR

The Power-Mate® has built-in protection against motor and belt damage should the agitator jam. If the agitator slows down or stops, the overload protector shuts off the Power-Mate®. The canister motor will continue to run.

*Overload Protector/  
Belt Reset Button*



**To correct problem:** Turn off and unplug vacuum cleaner, remove obstruction, then press **BELT RESET** button. A ball point pen may be required.

**If the problem persists, have the vacuum cleaner serviced by a Sears or other qualified service agent.**

### WARNING

#### Personal Injury Hazard

Always unplug the vacuum cleaner before cleaning the agitator area as agitator may suddenly restart. Failure to do so can result in personal injury.

### EDGE CLEANER

Active brush edge cleaners are on both sides of the Power-Mate®. Guide either side of the Power-Mate® along baseboards or next to furniture to help remove dirt trapped at carpet edges.



## SUCTION CONTROL

The suction control allows you to change the vacuum suction for different fabrics and carpet weights.

Opening the control decreases suction for draperies and lightweight rugs, while closing the control increases suction for upholsteries and carpets.

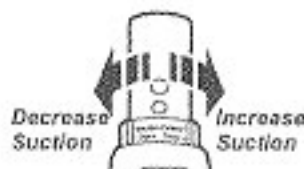

## PERFORMANCE INDICATOR

When the vacuum cleaner is running with normal airflow, the light on the performance indicator is off. The light comes on whenever the airflow becomes blocked. If that occurs, check the disposable dust bag, motor safety filter and other possible clog locations shown in **HOW YOUR VACUUM CLEANER WORKS**.



**To correct problem:** See the **TROUBLE-SHOOTING** table.

**NOTE:** The light may come on when using certain attachments, due to reduced airflow through attachment.

## THERMAL PROTECTOR

This vacuum cleaner has a thermal protector which automatically trips to protect the vacuum cleaner from overheating. If a clog prevents the normal flow of air to the motor, the thermal protector turns the motor off automatically. This allows the motor to cool in order to prevent possible damage to the vacuum cleaner.

**To correct problem:** Turn the vacuum cleaner off and unplug the power cord from the outlet to allow the vacuum cleaner to cool and the thermal protector to reset. **Check for and remove clogs, if necessary. Also check and replace any clogged filters. Wait approximately thirty (30) minutes and plug the vacuum cleaner in and turn back on to see if the motor protector has reset.**

## POWER-MATE® STORAGE

The wand has a "U" shaped flange that slides into the "U" shaped slot on the canister.

The flange allows the wands and Power-Mate® to be stored with the canister to conserve storage space. The canister must be stored on end for this feature to be used.

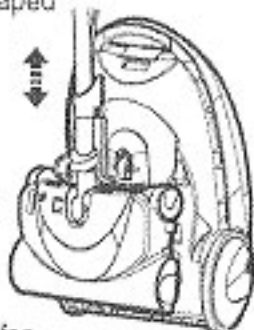

To attach the Power-Mate®, it must be in the flat position as shown in the illustration. Use the handle release pedal to place it in this position.

The wand will slip out of the slot as it is lifted up for use and will slide into the slot as it is lowered for storage.

## STAIR GRIP

During normal operation while the canister is in the horizontal position, the caster wheel rotates freely 360°.

The Stair Grip feature allows the caster wheel to lock in position when the vacuum cleaner is rotated 25°

from horizontal into a vertical position in order for the canister to rest on stairs.



## HOW YOUR VACUUM CLEANER WORKS

The vacuum cleaner creates suction that picks up dirt. Rapidly moving air carries the dirt to the dust bag through the airflow passages. The dust bag lets the air pass through, while it traps the dirt.

For best cleaning results, keep the airflow passage open. Check the starred areas occasionally for clogs. Unplug from outlet before checking.

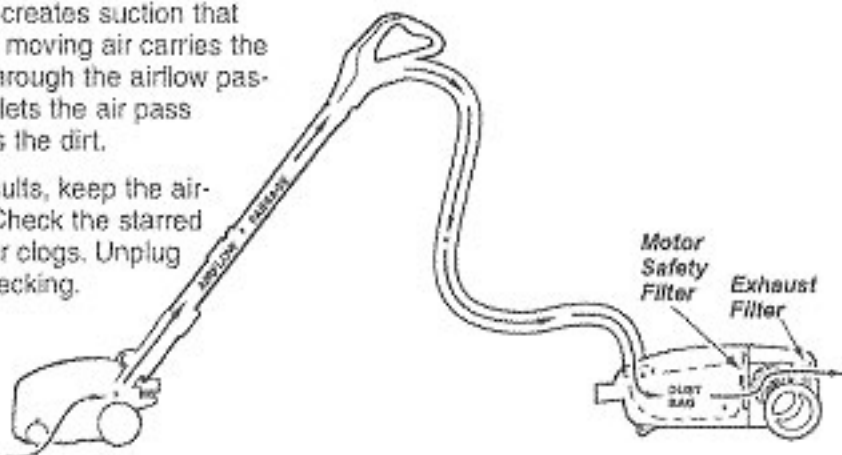

## CANISTER CARE

### BAG CHANGING

For best cleaning results, the dust bag should be changed often. The electronic performance indicator will come on when the bag needs to be changed or the airflow is blocked.

**NOTE:** See PARTS AND FEATURES for Bag Number.



1. Unplug cord from wall outlet.
2. Remove hose from canister.
3. Pull hood release out and up, then lift canister hood.

4. Disengage cardboard tab from red bag mount by pulling away and lifting up.

5. Pull bag out of the red bag mount.

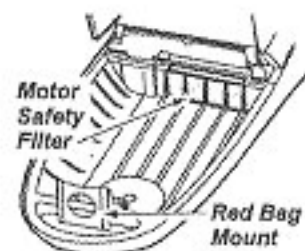

6. Check the motor safety filter and replace, if necessary.

7. The red bag mount will flip forward after removing bag. This will prevent the hood from closing until a new bag is installed.

**Note:** DO NOT bend or crease the middle of the cardboard when installing the bag into the bag mount slots.

8. Rotate red bag mount down and install bag into slots per illustration, pushing down until the cardboard tab locks into position and the holes align.

Tuck the bag securely into the bag cavity so that none of it is able to be pinched by the hood.

9. Close and latch canister hood.

10. Reinstall hose.

11. Plug cord into wall outlet.



### CAUTION

**NEVER REUSE A DUST BAG.** Very fine materials, such as carpet freshener, face powder, fine dust, plaster, soot, new carpet lint, etc. can clog the bag and cause it to burst before it is full and may cause damage to vacuum cleaner motor. Change bag more often when vacuuming these materials.

## CLEANING EXTERIOR AND ATTACHMENTS

1. Unplug cord from wall outlet. **DO NOT** drip water on vacuum cleaner.
2. Clean exterior using a clean, soft cloth that has been dipped in a solution of mild liquid detergent and water, then wrung dry. Wipe dry after cleaning.
3. To reduce static electricity and dust build-up, wipe outer surface of vacuum cleaner and attachments.

### CAUTION

Do not use attachments if they are wet. Attachments used in dirty areas, such as under a refrigerator, should not be used on other surfaces until they are washed. They could leave marks.

## MOTOR SAFETY FILTER CHANGING

### WARNING

#### Electrical Shock Hazard

Unplug power cord from electrical outlet. Do not operate the vacuum cleaner without the motor safety filter. Be sure the filter is dry and properly installed to prevent motor failure and/or electrical shock.

### MOTOR SAFETY FILTER ELECTROSTATIC

This filter must be replaced when dirty. It should be replaced regularly depending on use conditions. The filter **CANNOT** be washed as it will lose its dust trapping ability.

**NOTE:** See **PARTS AND FEATURES** for Motor Safety Filter number.

1. Remove the bag as outlined in the **BAG CHANGING** section.

2. Lift the rubber retainer and pull out motor safety filter as shown.



3. Replace the filter, **white side out**, facing the dust bag, by sliding it back into place under the ribs in the bag cavity. Tuck filter in so that it fits completely under the rubber retainer.

4. Replace the bag as outlined in the **BAG CHANGING** section.

## EXHAUST FILTER CHANGING

### WARNING

Fire and/or Electrical Shock Hazard

Do not operate with a clogged exhaust filter or without the exhaust filter or exhaust filter cover installed.

### EXHAUST FILTER HEPA

The exhaust filter cartridge must be replaced when dirty. Replace the filter when the entire surface area is covered evenly. The filter **CANNOT** be washed as it will lose its dust trapping ability.

**NOTE:** See **PARTS AND FEATURES** for Exhaust Filter number.

1. Pull out and up on the exhaust filter cover to remove from the canister and lay aside.

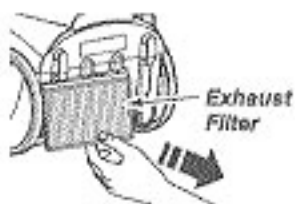
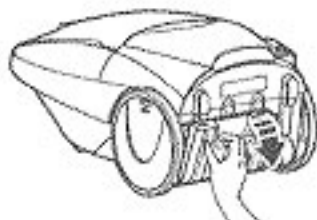

2. Pull the exhaust filter up and out from the rear of the canister.

3. Replace the exhaust filter cartridge. Place the new filter into the canister with the **foam seal facing towards the canister**.

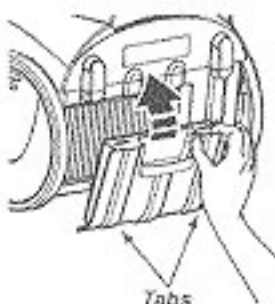
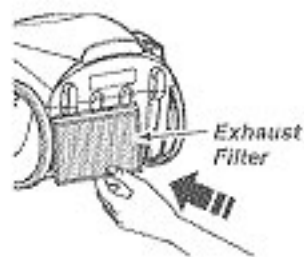

4. Replace the exhaust filter cover by placing the two tabs on the filter cover into the slots on the canister and rotate into place until it snaps closed.



## POWER-MATE® CARE

Always follow all safety precautions when performing maintenance to the Power-Mate®.

### WARNING

#### Electrical Shock Or Personal Injury Hazard

Disconnect electrical supply before performing maintenance to the vacuum cleaner. Failure to do so could result in electrical shock or personal injury from vacuum cleaner suddenly starting.

## BELT CHANGING AND AGITATOR CLEANING

### TO REMOVE BELT

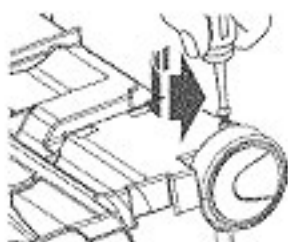

1. Turn Power-Mate® upside down.
2. Unscrew the two (2) Power-Mate® cover screws.

3. Turn Power-Mate® right side up. Press handle release pedal and lower the swivel. Lift rear latches up.

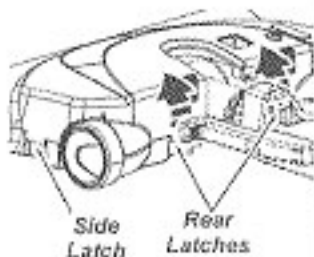

4. To remove cover, grasp the sides and pull out.

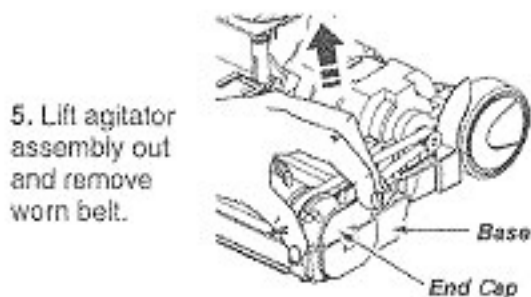

5. Lift agitator assembly out and remove worn belt.

6. Check and clean end cap areas. See **AGITATOR ASSEMBLY** for picture of complete agitator assembly.

### TO CLEAN AGITATOR:

**NOTE:** In order to keep cleaning efficiency high and to prevent damage to your vacuum cleaner, the agitator must be cleaned every time the belt is changed.

The agitator must also be cleaned according to the following schedule:

Vacuum Cleaner Use	Clean Agitator
HEAVY - (used daily)	every week
MODERATE - (used 2-3 times/week)	every month
LIGHT - (used 1 time/week)	every 2 months

### IMPORTANT

Disconnect vacuum cleaner from electrical outlet. Check and remove hair, string and lint build-up frequently in the Power-Mate® agitator and end cap areas.

Remove any dirt or debris in the belt path area or in the brush roller area.

Carefully remove any string or debris located on the agitator or end caps.

### AGITATOR ASSEMBLY

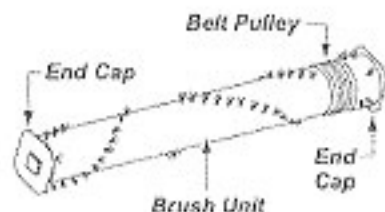

## TO REPLACE BELT

1. Install new belt over motor drive, then over belt pulley.

**NOTE:** See PARTS AND FEATURES for Belt number.

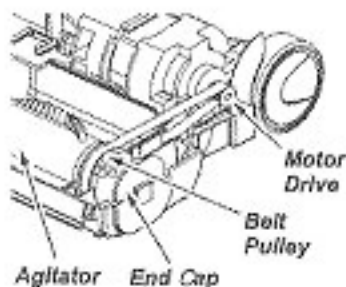
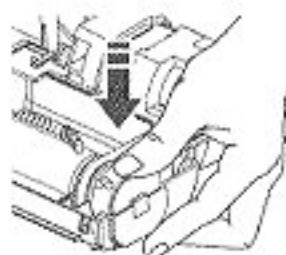

2. Place agitator assembly back into Power-Mate®.

3. Line up front of cover and base. Rest cover on front edge of base as shown.

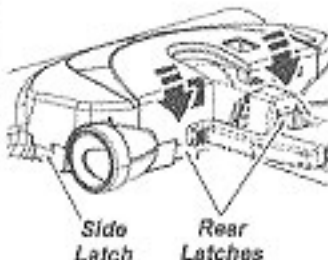
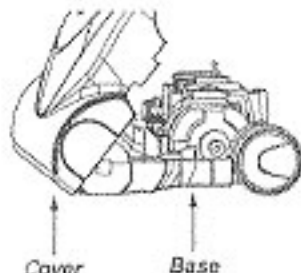

4. Rotate cover back. Press cover firmly until side and rear latches snap into place.

Make sure there is no gap between the cover and base.

5. Turn Power-Mate® upside down and replace two (2) cover screws.

## LIGHT BULB CHANGING

1. Remove Power-Mate® cover as shown in BELT CHANGING AND AGITATOR CLEANING section.

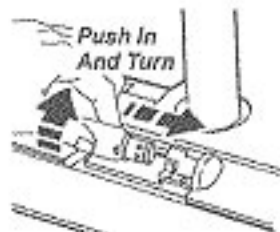

2. Push in and turn bulb counterclockwise, then pull out to remove.

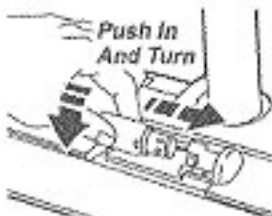

3. Push in and turn bulb clockwise, to replace. Bulb must not be higher than 15 Watts (130 Volts).

4. Reinstall Power-Mate® cover as shown in BELT CHANGING AND AGITATOR CLEANING section.

**NOTE:** See PARTS AND FEATURES for bulb number.

## AGITATOR SERVICING

### **WARNING**

Electrical Shock Or Personal Injury Hazard

Disconnect electrical supply before performing maintenance to the vacuum cleaner. Failure to do so could result in electrical shock or personal injury from vacuum cleaner suddenly starting.

### TO CHECK THE BRUSHES



When brushes are worn to the level of the base support bars, replace the agitator assembly.

### TO REPLACE AGITATOR ASSEMBLY

1. Remove Power-Mate® cover, belt and agitator assembly. See "To Remove Belt" in **BELT CHANGING AND AGITATOR CLEANING**.
2. Replace agitator assembly.
3. Reinstall belt and Power-Mate® cover. See "To replace belt" in **BELT CHANGING AND AGITATOR CLEANING**.

## TROUBLESHOOTING

Review this table to find do-it-yourself solutions for minor performance problems. Any other service needed, should be performed by a Sears or other qualified service agent.

### **WARNING**

**Disconnect electrical supply before performing maintenance to the vacuum cleaner. Failure to do so could result in electrical shock or personal injury.**

PROBLEM	POSSIBLE CAUSE	POSSIBLE SOLUTION
Vacuum cleaner won't start.	<ol style="list-style-type: none"> <li>1. Unplugged at wall outlet.</li> <li>2. Tripped circuit breaker/blown fuse at household service panel.</li> <li>3. Loose hose electrical connections.</li> </ol>	<ol style="list-style-type: none"> <li>1. Plug in firmly, push ON/OFF switch to ON.</li> <li>2. Reset circuit breaker or replace fuse.</li> <li>3. Reconnect hose ends.</li> </ol>
Poor job of dirt pickup.	<ol style="list-style-type: none"> <li>1. Full or clogged dust bag.</li> <li>2. Clogged airflow passages.</li> <li>3. Dirty filters.</li> <li>4. Wrong pile height setting.</li> <li>5. Suction control is open.</li> <li>6. Hole in hose.</li> <li>7. Worn Power-Mate® agitator.</li> <li>8. Worn or broken belt.</li> <li>9. Dirty agitator or end caps.</li> <li>10. Canister hood open.</li> </ol>	<ol style="list-style-type: none"> <li>1. Change bag.</li> <li>2. Clear airflow passages.</li> <li>3. Change filters.</li> <li>4. Adjust setting.</li> <li>5. Adjust control.</li> <li>6. Replace hose.</li> <li>7. Change agitator.</li> <li>8 &amp; 9. See <b>BELT CHANGING AND AGITATOR CLEANING</b>.</li> <li>10. Close and latch hood.</li> </ol>
Vacuum cleaner starts but shuts off.	<ol style="list-style-type: none"> <li>1. Hose or hood electrical connections.</li> <li>2. Tripped overload protector in Power-Mate®.</li> <li>3. Tripped thermal protector in canister.</li> </ol>	<ol style="list-style-type: none"> <li>1. Check connections, reconnect hose ends.</li> <li>2. Remove any items that may be caught or jammed, then reset. If vacuum cleaner starts and stops again, clean agitator and end caps, then reset.</li> <li>3. Reset thermal protector.</li> </ol>
Power-Mate® will not run when attached.	<ol style="list-style-type: none"> <li>1. Power-Mate® connections unplugged.</li> <li>2. Worn or broken belt.</li> <li>3. Dirty agitator or end caps.</li> <li>4. Tripped overload protector in Power-Mate®.</li> <li>5. Switch not in CARPET position.</li> </ol>	<ol style="list-style-type: none"> <li>1. Plug in firmly.</li> <li>2 &amp; 3. See <b>BELT CHANGING AND AGITATOR CLEANING</b>.</li> <li>2. Remove any items that may be caught or jammed, then reset. If vacuum cleaner starts and stops again, clean agitator and end caps, then reset.</li> <li>5. Move switch to CARPET position.</li> </ol>
Performance Indicator activates.	<ol style="list-style-type: none"> <li>1. Full or clogged dust bag.</li> <li>2. Dirty filters.</li> <li>3. Blocked airflow passage.</li> <li>4. Certain attachment tools.</li> </ol>	<ol style="list-style-type: none"> <li>1. Change bag.</li> <li>2. Change filters.</li> <li>3. Clear blockage from airflow passage.</li> <li>4. This is normal. Light should go off when tool is removed.</li> </ol>
Vacuum cleaner picks up moveable rugs - or Power-Mate® pushes too hard.	<ol style="list-style-type: none"> <li>1. Wrong pile height setting.</li> <li>2. Suction too strong.</li> </ol>	<ol style="list-style-type: none"> <li>1. Adjust setting.</li> <li>2. Open suction control.</li> </ol>
Light won't work.	<ol style="list-style-type: none"> <li>1. Burned out light bulb.</li> </ol>	<ol style="list-style-type: none"> <li>1. Change light bulb.</li> </ol>
Cord won't rewind.	<ol style="list-style-type: none"> <li>1. Dirty power cord.</li> <li>2. Cord jammed.</li> </ol>	<ol style="list-style-type: none"> <li>1. Clean the power cord.</li> <li>2. Pull out cord and rewind.</li> </ol>
Vacuum cleaner leaves marks on carpet.	<ol style="list-style-type: none"> <li>1. Wrong vacuuming pattern.</li> </ol>	<ol style="list-style-type: none"> <li>1. See <b>VACUUMING TIPS</b>.</li> </ol>