

This Owner's Manual is provided and hosted by [Appliance Factory Parts](#).



# Coleman 5434A700 Owner's Manual

[Shop genuine replacement parts for Coleman  
5434A700](#)



[Find Your Coleman Camping Parts - Select From 855 Models](#)

----- Manual continues below -----



Propane Stoves  
Réchauds à propane  
Estufas de gas Propano

Instructions for use  
Notice d'emploi  
Instrucciones de uso

© 2008 The Coleman Company, Inc.  
www.coleman.com



## 5432A Series

Standard Ignition  
Allumage standard  
Encendido estándar



ANSI Z21.72b - CSA 11.2b (2002)  
Camp Stove  
Poêle de camping  
Estufa de campamento

### IMPORTANT

Read this manual carefully before assembling, using or servicing these stoves. Keep this manual for future reference. If you have questions about assembly, operation, servicing or repair of these stoves, please call Coleman at 1-800-835-3278 or TDD: 316-832-8707. In Canada call 1-800-387-6161.

### IMPORTANT

Lisez attentivement ce manuel avant d'assembler, d'utiliser ou de réparer le réchaud et gardez-le pour référence ultérieure. Pour toute question en ce qui concerne l'assemblage, le fonctionnement, l'entretien ou la réparation, appelez Coleman au 1 800 835-3278 ou ATS 316-832-8707 aux États-Unis et au 1 800 387-6161 au Canada.

### IMPORTANTE

Lea este manual cuidadosamente antes de ensamblar, usar o reparar esta estufa. Guarde este manual para uso de referencia en el futuro. Si tiene alguna pregunta acerca del ensamblaje, uso, compostura o reparaciones a la estufa, por favor llame a Coleman al 1-800-835-3278 o TDD: 316-832-8707. En Canada llame al 1-800-387-6161.

## FOR YOUR SAFETY

If you smell gas:

1. Do not attempt to light appliance.
2. Extinguish any open flame.
3. Disconnect from fuel supply.

This manual contains important information about the assembly, operation and maintenance of this outdoor propane appliance. General safety information is presented on this page and is also located throughout these instructions. Particular attention should be paid to information accompanied by the safety alert symbol "▲ DANGER", "▲ WARNING", "▲ CAUTION".

Keep this manual for future reference and to educate new users of this product. This manual should be read in conjunction with the labeling on the product.

Safety precautions are essential when any mechanical or propane fueled equipment is involved. These precautions are necessary when using, storing, and servicing. Using this equipment with the respect and caution demanded will reduce the possibilities of personal injury or property damage.

The following symbols shown below are used extensively throughout these instructions. Always heed these precautions, as they are essential when using any mechanical or propane fueled equipment.

## FOR YOUR SAFETY

Do not store or use gasoline or other liquids with flammable vapors in the vicinity of this or any other appliance.

### ▲ DANGER

DANGER indicates an imminently hazardous situation which, if not avoided, will result in death or serious injury.

### ▲ WARNING

WARNING indicates a potentially hazardous situation which, if not avoided, could result in death or serious injury.

### ▲ CAUTION

CAUTION indicates a potentially hazardous situation which, if not avoided, may result in minor or moderate personal injury, or property damage.

### ▲ DANGER

Failure to comply with the precautions and instructions provided with these stoves can result in death, serious bodily injury and property loss or damage from hazards of fire, explosion, burn, asphyxiation, and/or carbon monoxide poisoning.

Only persons who can understand and follow the instructions should use or service these stoves.

If you need assistance or information such as an instruction manual or labels, contact The Coleman Company, Inc.

#### CALIFORNIA PROPOSITION 65:

**WARNING:** This fuel, and byproducts of combustion of this fuel, contain chemicals known to the state of California to cause cancer, birth defects, or other reproductive harm.

### ▲ DANGER



### CARBON MONOXIDE HAZARD

- This appliance can produce carbon monoxide which has no odor.
- Using it in an enclosed space can kill you.
- Never use this appliance in an enclosed space such as a camper, tent, car or home.

## ⚠ WARNING

- This product is fueled by propane gas. Propane gas is invisible, odorless, and flammable. An odorant is normally added to help detect leaks and can be described as a "rotten egg" smell. The odorant can fade over time so leaking gas is not always detectable by smell alone.
- Propane gas is heavier than air and leaking propane will sink to the lowest level possible. It can ignite by ignition sources including matches, lighters, sparks or open flames of any kind many feet away from the original leak. Use only propane gas set up for vapor withdrawal.
- Propane gas should be stored or used in compliance with local ordinances and codes or with ANSI/NFPA 58. Turn off propane when not in use.

## ⚠ DANGER



### • EXPLOSION - FIRE HAZARD

- Never store propane near high heat, open flames, pilot lights, direct sunlight, other ignition sources or where temperatures exceed 120 degrees F (49°C).
- Propane is heavier than air and can accumulate in low places. If you smell gas, leave the area immediately.
- Never install or remove propane tank while outdoor stove is lighted, near flame, pilot lights, other ignition sources or while outdoor stove is hot to touch.
- During lighting and operation, this product can be a source of ignition. Never use the stove in spaces that contain or may contain volatile or airborne combustibles, or products such as gasoline, solvents, paint thinner, dust particles or unknown chemicals. Minimum clearances from combustible materials: 12 inches from the sides and 48 inches from the top.
- Provide adequate clearances around air openings into the combustion chamber.

## ⚠ WARNING

Not for home or recreational vehicle use.

We cannot foresee every use which may be made of our products.

**Check with your local fire safety authority if you have questions about use.**

Other standards govern the use of fuel gases and heat producing products for specific uses. Your local authorities can advise you about these.

- Never refill disposable cylinders.
- Use the preset regulator that came with the stove. Do not attempt to adjust.
- Use only Coleman® accessories or parts. During stove set-up, check all fittings for leaks using soapy water. Never use a flame.

## ⚠ WARNING



### • BURN HAZARD

- Never leave stove unattended when hot or in use.
- Keep out of reach of children.

## ⚠ DANGER



### • CARBON MONOXIDE HAZARD

- This stove is a combustion appliance. All combustion appliances produce carbon monoxide (CO) during the combustion process. This product is designed to produce extremely minute, non-hazardous amounts of CO if used and maintained in accordance with all warnings and instructions. Do not block air flow into or out of the stove.
- Carbon Monoxide (CO) poisoning produces flu-like symptoms, watery eyes, headaches, dizziness, fatigue and possibly death. You can't see it and you can't smell it. It's an invisible killer. If these symptoms are present during operation of this product **get fresh air immediately!**
- **For outdoor use only.**
- **Never use inside house, camper, tent, vehicle or other unventilated or enclosed areas. This stove consumes air (oxygen). Do not use in unventilated or enclosed areas to avoid endangering your life.**

## ⚠ CAUTION

### • SERVICE SAFETY

- Keep all connections and fittings clean. Inspect propane cylinder and stove propane connections for damage before attaching.
- During set up, check all connections and fittings for leaks using soapy water. Never use a flame. Bubbles indicate a leak. Check that the connection is not cross-threaded and that it is tight. Perform another leak check. If there is still a leak, remove the cylinder and contact Coleman for service or repairs.
- Use as a cooking appliance only. Never alter in any way or use with any device or part not expressly approved by Coleman.
- Clean stove frequently to avoid grease accumulation and possible grease fires.

## Technical Characteristics

Input: 10,000 BTU/H per burner  
Category: Pressure regulated propane  
Fuel: 16.4 oz. disposable propane cylinders  
Regulator: 5431

## To Set Up

### ⚠ DANGER



#### • CARBON MONOXIDE HAZARD

- For outdoor use only.
- Never use inside house, camper, tent, vehicle or other unventilated or enclosed areas. This stove consumes air (oxygen). Do not use in unventilated or enclosed areas to avoid endangering your life.

NOTE: Use Coleman® 16.4 oz. disposable propane cylinders. The LP-gas cylinder(s) used with stoves must be constructed and marked in accordance with the specifications for LP-gas cylinders of the U.S. Department of Transportation or *Transport Canada, CAN/CSA B339*.

- Turn FUEL VALVE "off". (Fig. 1)

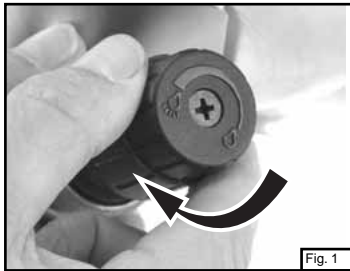

Fig. 1

### ⚠ CAUTION

#### • SERVICE SAFETY

- Keep all connections and fittings clean. Inspect propane cylinder and stove propane connections for damage before attaching.
- During set up, check all connections and fittings for leaks using soapy water. Bubbles indicate a leak. Never use a flame.

- Remove protective cap from top of propane cylinder. Save cap for use in storing.
- Screw propane cylinder into stove. Take care not to cross thread. HAND TIGHTEN only. (Fig. 2)



Fig. 2

- Place cylinder securely in stove base. (Fig. 3)



Fig. 3

## Leak Check

### ⚠ WARNING

- Perform leak test outdoors.
- Extinguish all open flames.
- NEVER leak test when smoking.
- Do not use the outdoor stove until connection has been leak tested and does not leak.

## To Light

### ⚠ DANGER



#### • EXPLOSION - FIRE HAZARD

- Propane is heavier than air and can accumulate in low places. If you smell gas, leave the area immediately.
- Always attach or detach propane source outdoors; never while stove is lighted, near flame, pilot lights, other ignition sources or while stove is hot to touch.
- This stove is red hot during use and can ignite flammables too close to the burners. Keep flammables at least 12 inches from the sides and 48 inches from the top of the stove. Keep gasoline and other flammable liquids and vapors well away from stove.
- The stove must not be exposed to flammable vapors or liquids during lighting.

### ⚠ WARNING



#### • BURN HAZARD

- Never leave stove unattended when hot or in use.
- Keep out of reach of children.

## Match Light:

- Set on sturdy, flat surface. For outdoor use only.
- Hold lighted match at burner and open FUEL VALVE. (Fig. 4)



Fig. 4

- Adjust flame to desired heat with FUEL VALVE. (Fig. 5)
- Flame should be blue with hint of yellow on tips.

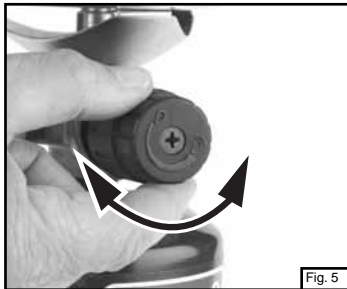

Fig. 5

## To Turn Off

- Turn FUEL VALVE "off". (Fig. 6)



Fig. 6

## To Clean

- Make sure stove is cool.
- Move stove away from flame (including pilot lights) and other ignition sources.
- Remove propane cylinder from stove. (Fig. 7)
- Replace protective cap on propane cylinder.



Fig. 7

### • MAINTENANCE

- Keep stove area clear and free from combustible materials, gasoline and other flammable vapors and liquids.
- Do not obstruct the flow of combustion and ventilation air.
- A good flame should be blue with minimal yellow tip. Some yellow tips on flames are acceptable as long as no carbon or soot deposits appear.
- Wipe clean with soft cloth and mild dish detergent. Do not use abrasives.

## To Store

### ⚠ DANGER



#### • EXPLOSION - FIRE HAZARD

- Never store propane near high heat, open flames, pilot lights, direct sunlight, other ignition sources or where temperatures exceed 120 degrees F (49°C).
- The cylinder must be disconnected when the stove is in storage.

## Things You Should Know

1. It is unsafe and illegal in some places to store or use propane cylinders of greater than 1.14 kg (2.5 lbs) water capacity (approximately 1 lb. propane) in occupied enclosures.
2. The usual storage areas for camping and picnic equipment are the basement, attic, or garage. To avoid the accumulation of dust, cobwebs, etc., that is common in these areas, place your stove in a plastic bag and seal it with a rubber band.
3. For repair service call one of the numbers on the front cover for location of your nearest Coleman Service Center. If a service center is not conveniently located, attach to the product a tag that includes your name, address, daytime telephone number and description of the problem. Carefully package the product and send either by **courier** or **insured mail** with shipping and **insurance** prepaid to:

#### For products purchased in the United States:

The Coleman Company, Inc.  
3600 North Hydraulic  
Wichita, KS 67219

#### For products purchased in Canada:

Sunbeam Corporation (Canada) Limited  
DBA Jarden Consumer Solutions  
20B Hereford Street  
Brampton, ON L6Y 0M1

4. If not completely satisfied with the performance of this product, please call 1-800-835-3278 in the US or 1 800 387-6161 in Canada.  
**www.coleman.com**

## Parts List

No.	Part Number	Description
1	5431-1321	Burner Assy. (matchlight)
2	5431-5261	Regulator Assembly
3	R438C545C	Base
4	9950-1491	Knob Assembly

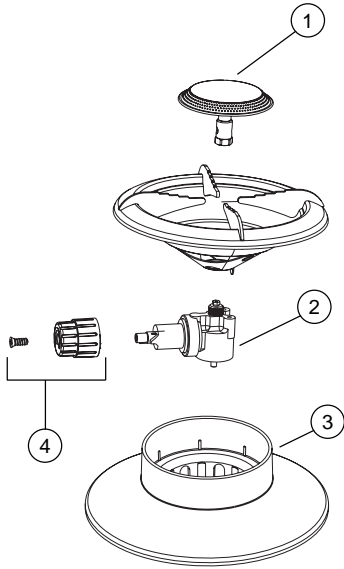

## Warranty

### Limited Five Year Warranty

The Coleman Company, Inc. ("Coleman") warrants that for a period of five years from the date of original retail purchase, this product will be free from defects in material and workmanship. Coleman, at its option, will repair or replace this product or any component of the product found to be defective during the warranty period. Replacement will be made with a new or remanufactured product or component. If the product is no longer available, replacement may be made with a similar product of equal or greater value. This is your exclusive warranty.

This warranty is valid for the original retail purchaser from the date of initial retail purchase and is not transferable. Keep the original sales receipt. Proof of purchase is required to obtain warranty performance. Coleman dealers, service centers, or retail stores selling Coleman® products do not have the right to alter, modify or in any way change the terms and conditions of this warranty.

#### What This Warranty Does Not Cover

This warranty does not cover normal wear of parts, parts that are not genuine Coleman® parts, or damage resulting from any of the following: negligent use or misuse of the product; use on improper voltage or current; commercial use of the product; use contrary to the operating instructions; disassembly, repair or alteration by anyone other than Coleman or an authorized service center. Further, the warranty does not cover Acts of God, such as fire, flood, hurricanes and tornadoes. Warranty void if damage to product results from the use of a part other than a genuine Coleman® part.

COLEMAN SHALL NOT BE LIABLE FOR DEFECTS THAT ARE CAUSED BY THE USE OF UNAUTHORIZED PARTS OR SERVICE. COLEMAN SHALL NOT BE LIABLE FOR ANY INCIDENTAL OR CONSEQUENTIAL DAMAGES CAUSED BY THE BREACH OF ANY EXPRESS OR IMPLIED WARRANTY OR CONDITIONS. EXCEPT TO THE EXTENT PROHIBITED BY APPLICABLE LAW, ANY IMPLIED WARRANTY OF MERCHANTABILITY OR FITNESS FOR A PARTICULAR PURPOSE IS LIMITED IN DURATION TO THE DURATION OF THE ABOVE WARRANTY OR CONDITIONS. SOME STATES, PROVINCES, OR JURISDICTIONS DO NOT ALLOW THE EXCLUSION OR LIMITATION OF INCIDENTAL OR CONSEQUENTIAL DAMAGES OR LIMITATIONS ON HOW LONG AN IMPLIED WARRANTY LASTS, SO THE ABOVE LIMITATIONS OR EXCLUSION MAY NOT APPLY TO YOU. THIS WARRANTY GIVES YOU SPECIFIC LEGAL RIGHTS, AND YOU MAY ALSO HAVE OTHER RIGHTS THAT VARY FROM STATE TO STATE OR PROVINCE TO PROVINCE.

#### How to Obtain Warranty Service

Take the product to an authorized Coleman service center. You can find the nearest authorized Coleman service center by visiting [www.coleman.com](http://www.coleman.com) or calling 1-800-835-3278 or TDD 316-832-8707 in the United States or 1 800 387-6161 in Canada. If a service center is not conveniently located, attach to the product a tag that includes your name, address, daytime telephone number and description of the problem. Include a copy of the original sales receipt. Carefully package the product and send either by **courier** or **insured mail** with shipping and **insurance** prepaid to:

#### For products purchased in the United States:

The Coleman Company, Inc.  
3600 North Hydraulic  
Wichita, KS 67219

#### For products purchased in Canada:

Sunbeam Corporation (Canada) Limited  
DBA Jarden Consumer Solutions  
20B Hereford Street  
Brampton, ON L6Y 0M1

The costs of transporting the product to Coleman or an authorized service center for warranty service is the responsibility of the purchaser.

Do not mail products with fuel in tanks, or with disposable propane cylinders. Remove glass globes from lanterns and wrap separately.



**DO NOT RETURN THIS PRODUCT TO THE PLACE OF PURCHASE.**



If you have any questions regarding this warranty please call 1-800-835-3278 or TDD 316-832-8707 in the United States or 1 800 387-6161 in Canada.





The Coleman Company, Inc. • 3600 N. Hydraulic • Wichita, KS 67219 U.S.A.  
1-800-835-3278 • TDD: 316-832-8707

Sunbeam Corporation (Canada) Limited • DBA Jarden Consumer Solutions  
20B Hereford Street • Brampton, ON L6Y 0M1 • 1 800 387-6161

© 2008 The Coleman Company, Inc. All rights reserved. Coleman®  and  are registered trademarks of The Coleman Company, Inc.

© 2008 The Coleman Company, Inc. Tous droits réservés. Coleman®  et  sont des marques déposées de The Coleman Company, Inc.

© 2008 The Coleman Company, Inc. Todos los derechos reservados. Coleman®  y  son marcas registradas de The Coleman Company, Inc.

[www.coleman.com](http://www.coleman.com)  
[www.colemancanada.ca](http://www.colemancanada.ca)

4010002975 (20080114)