

This Owner's Manual is provided and hosted by [Appliance Factory Parts](http://www.appliancefactoryparts.com).

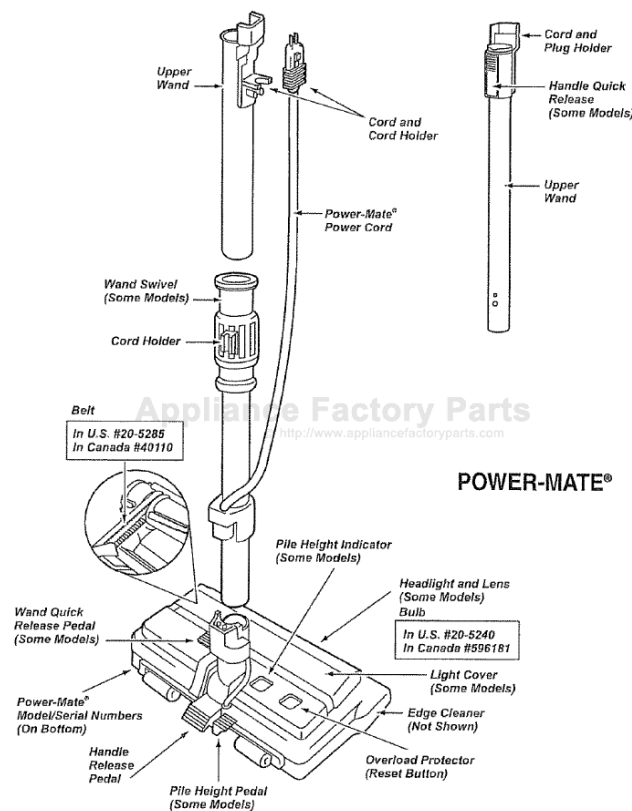

# Kenmore 116.21513001 Owner's Manual

[Shop genuine replacement parts for Kenmore  
116.21513001](#)



[Find Your Kenmore Vacuum Cleaner Parts - Select From 745 Models](#)

----- Manual continues below -----

# *Owner's Manual*



## *Vacuum Cleaner*

Model 116.20512  
116.21513

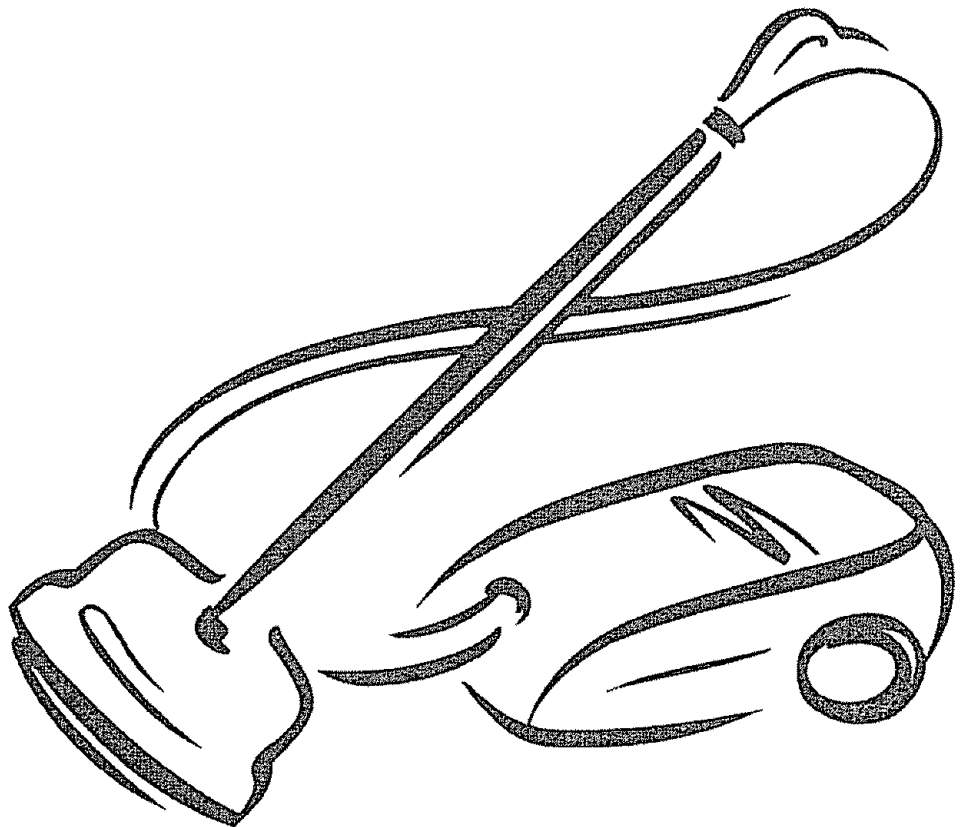

**CAUTION:**  
Read and follow all  
safety and operating  
instructions before first  
use of this product.

Sears, Roebuck and Co., Hoffman Estates, IL 60179 U.S.A.  
[www.sears.com](http://www.sears.com)

Part No. C01ZAXV30U00-8175162

Printed in U.S.A.

## TABLE OF CONTENTS

<b>Before Using Your New Vacuum</b> . . . . .	2	<b>Canister Care</b> . . . . .	12
<b>Kenmore Vacuum Cleaner Warranty</b> . . . . .	2	Bag Changing . . . . .	12
<b>Important Safety Instructions</b> . . . . .	3	Cleaning Exterior and Attachments . . . . .	13
<b>Parts and Features</b> . . . . .	4-5	Motor Safety Filter Changing . . . . .	13
<b>Assembly Instructions</b> . . . . .	6-7	Exhaust Filter Changing . . . . .	14
<b>Use</b> . . . . .	8	<b>Power-Mate® Care</b> . . . . .	14
How to Start . . . . .	8	Light Bulb Changing . . . . .	15
Vacuuming Tips . . . . .	9	Belt Changing and Brush Cleaning . . . . .	15-16
Suggested Pile Height Settings . . . . .	9	Brush Servicing . . . . .	17
Attachments . . . . .	10	Brush Assembly . . . . .	17
Attachment Use Chart . . . . .	10	<b>Troubleshooting</b> . . . . .	18
Performance Features . . . . .	11	<b>Requesting Assistance Or Service</b> . . . . .	19
<b>How Your Vacuum Works</b> . . . . .	12		

## BEFORE USING YOUR NEW VACUUM

Please read this guide. It will help you assemble and operate your new Kenmore vacuum in the safest and most effective way.

For more information about vacuum cleaner care and operation, call your nearest Sears store. You will need the complete model and serial numbers when requesting information. Your vacuum's model and serial numbers are located on the Model and Serial Number Plate.

Use the space below to record the model number and serial number of your new Kenmore vacuum.

Model No. \_\_\_\_\_

Serial No. \_\_\_\_\_

Date of Purchase \_\_\_\_\_

Keep this book and your sales check (receipt) in a safe place for future reference.

## KENMORE VACUUM CLEANER WARRANTY

### LIMITED ONE YEAR WARRANTY ON KENMORE VACUUM CLEANER

This warranty is for one year from the date of purchase, and includes only private household vacuum cleaner use. During the warranty year, when this vacuum cleaner is operated and maintained according to the owner's manual instructions, Sears will repair any defects in material or workmanship free of charge.

This warranty excludes vacuum bags, belts, light bulbs, and filters, which are expendable parts and become worn during normal use.

**For warranty service, return this vacuum cleaner to the nearest Sears Service Center in the United States.**

This warranty applies only while this product is in use in the United States. This warranty gives you specific legal rights, and you may also have other rights which vary from state to state.

**Sears, Roebuck and Co., D/817 WA, Hoffman Estates, IL 60179**

# IMPORTANT SAFETY INSTRUCTIONS



## WARNING

Your safety is important to us. To reduce the risk of fire, electrical shock, injury to persons or damage when using your vacuum cleaner, follow basic safety precautions including the following:

**Read** this manual before assembling or using your vacuum cleaner.

**Use** your cleaner only as described in this manual. Use only with Sears recommended attachments.

To reduce the risk of electrical shock – **Do not** use outdoors or on wet surfaces.

**Disconnect** electrical supply before servicing or cleaning out brush area. Failure to do so could result in electrical shock or brush suddenly starting.

**Always** turn cleaner off before connecting or disconnecting the hose or Power-Mate®.

**Always** turn cleaner off before unplugging.

**Do not** unplug by pulling on cord. To unplug, grasp the plug, not the cord.

**Hold** plug when rewinding onto cord reel. Do not allow plug to whip when rewinding.

**Do not** use with damaged cord or plug. If cleaner is not working as it should, has been dropped, damaged, left outdoors, or dropped into water, return it to a Sears Service Center.

**Do not** pull or carry by cord, use cord as a handle, close door on cord, or pull cord around sharp edges or corners. Do not run cleaner over cord. Keep cord away from heated surfaces.

**Do not** leave cleaner when plugged in. Unplug from outlet when not in use and before servicing.

**Do not** allow to be used as a toy. Close attention is necessary when used by or near children.

**Do not** handle plug or cleaner with wet hands.

**Do not** put any objects into openings.

**Do not** operate the cleaner with a punctured hose. The hose contains electrical wires. Replace if cut or worn. Avoid picking up sharp objects.

**Do not** use with any opening blocked; keep free of dust, lint, hair and anything that may reduce air flow.

**Keep** hair, loose clothing, fingers, and all parts of body away from openings and moving parts.

**Do not** use cleaner without dust bag and/or filters in place.

**Always** change the dust bag after vacuuming carpet cleaners or freshener, powders and fine dust. These products clog the bag, reduce airflow and can cause the bag to burst. Failure to change bag could cause permanent damage to the cleaner.

**Do not** use the cleaner to pick up sharp hard objects, small toys, pins, paper clips, etc. They may damage the cleaner or dust bag.

**Do not** pick up anything that is burning or smoking, such as cigarettes, matches, or hot ashes.

**Do not** use cleaner to pick up flammable or combustible liquids (gasoline, cleaning fluids, perfumes, etc.), or use in areas where they may be present. The fumes from these substances can create a fire hazard or explosion.

**Use extra care** when cleaning on stairs. Do not put on chairs, tables, etc. Keep on floor.

**You** are responsible for making sure that your vacuum cleaner is not used by anyone unable to operate it properly.

**Do not** operate without exhaust filter or exhaust filter cover installed.

## SAVE THESE INSTRUCTIONS

Proper assembly and safe use of your vacuum cleaner are your responsibilities. Your cleaner is intended only for household use. Read this Owner's Manual carefully for important use and safety information. This guide contains safety statements under warning and caution symbols. Please pay special attention to these boxes and follow any instructions given. **WARNING** statements alert you to such dangers as fire, electrical shock, burns and personal injury. **CAUTION** statements alert you to such dangers as personal injury and/or property damage.

# PARTS AND FEATURES

It is important to know your vacuum cleaner's parts and features to assure its proper and safe use. Review these before using your cleaner.

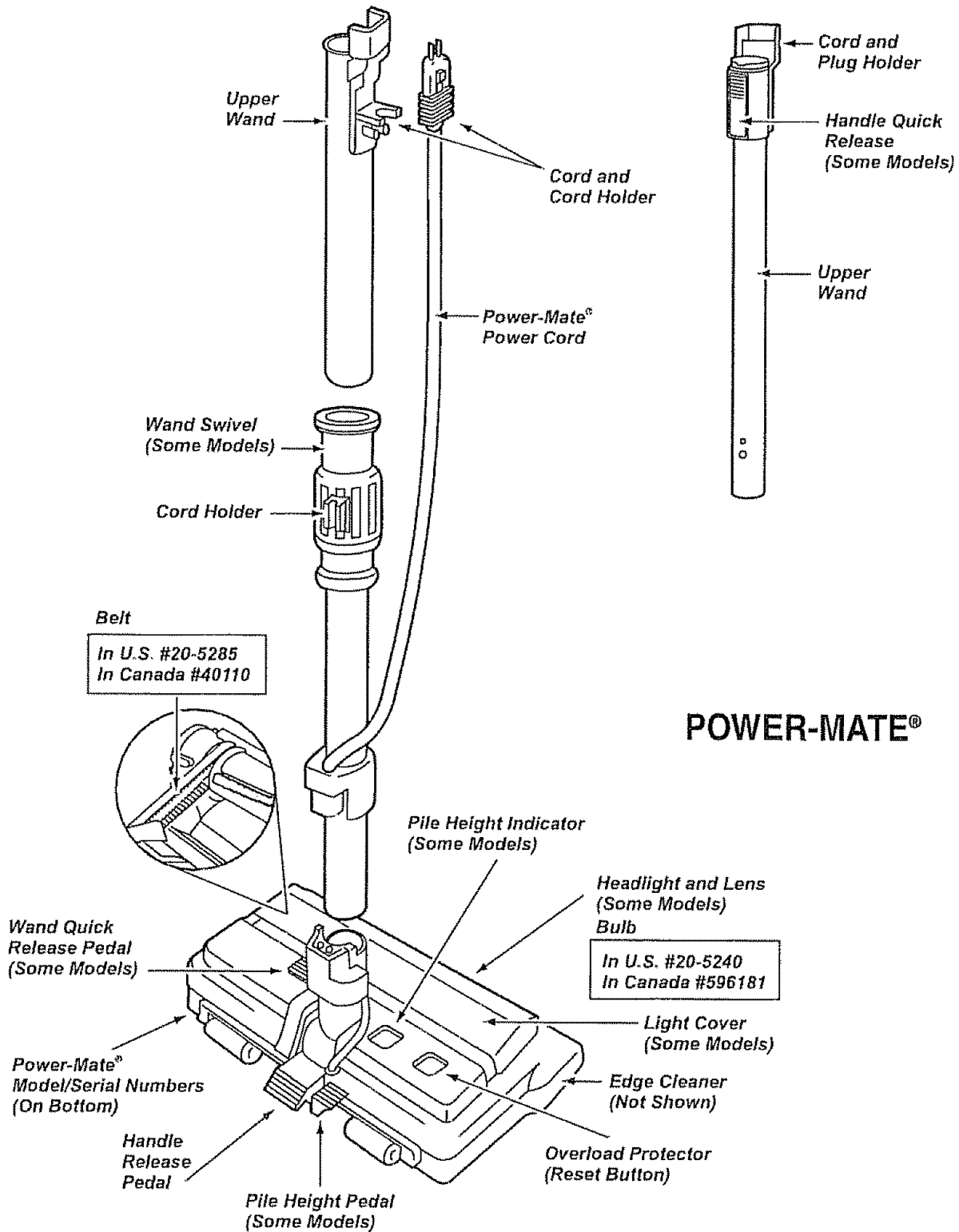

## HOSE

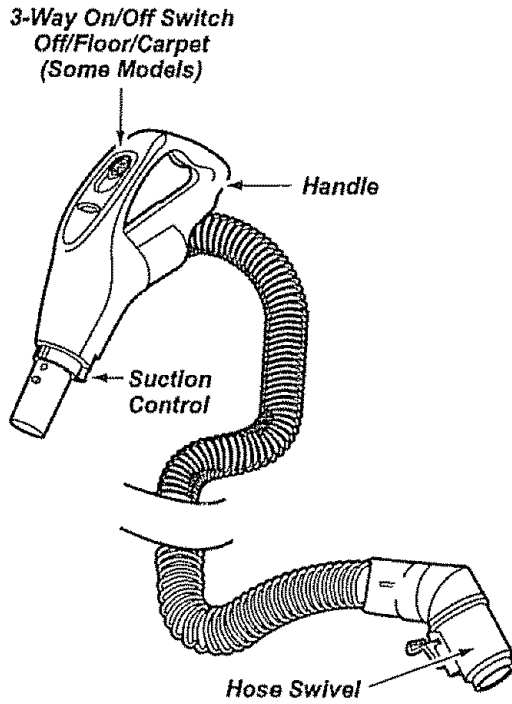

## ATTACHMENTS

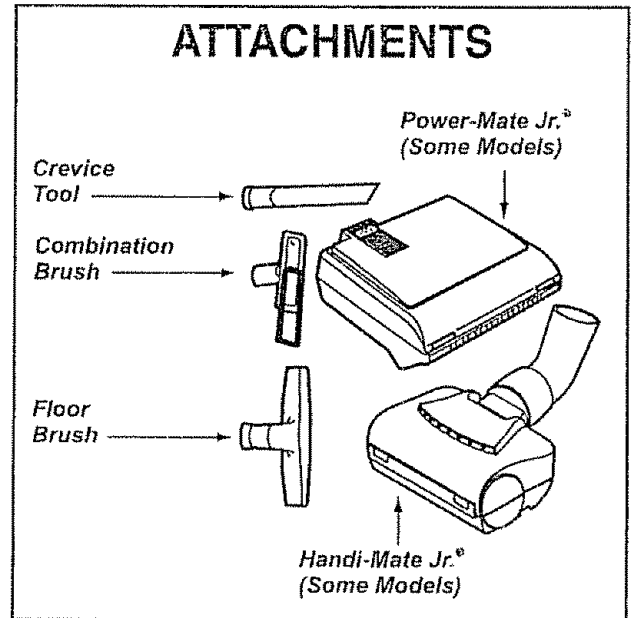

**NOTE:** All models have one set of attachments in the canister. Some models have an additional set, which can be kept in the accessory bag for garage use.

## CANISTER

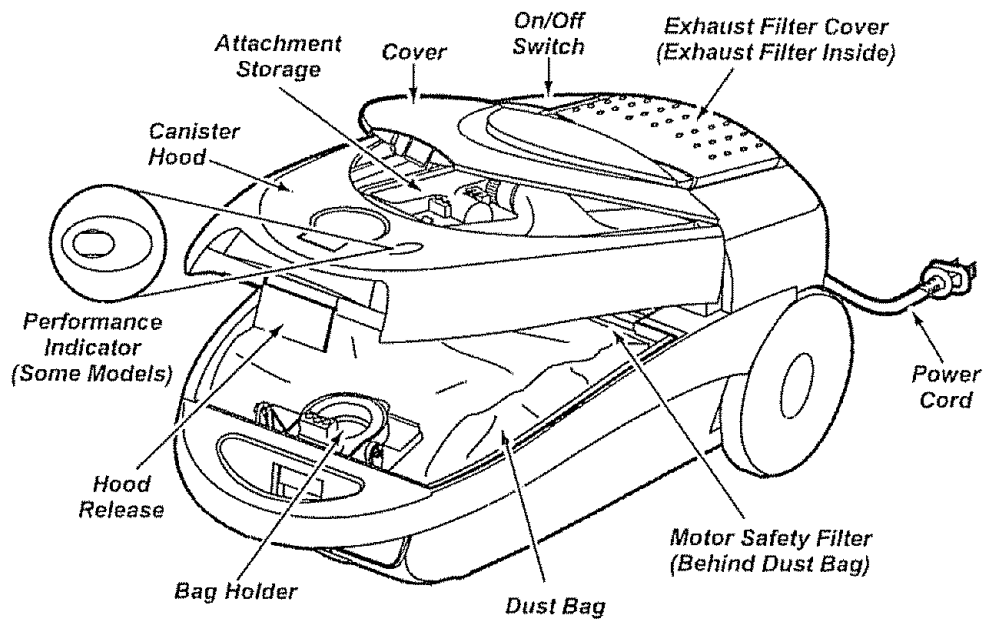

In U.S. #20-50558  
In Canada #20-50555

# ASSEMBLY INSTRUCTIONS



## WARNING

### Electrical Shock Hazard

**DO NOT** plug into electrical supply until assembly is complete. Failure to do so could result in electrical shock or injury.

Before assembling vacuum, check the PACKING LIST on the cover of the separate Repair Parts List. Use this list to verify that you have received all the components of your new Kenmore vacuum.

## WANDS

Slide wands together until wand button snaps into place. Turn wand button to the slotted area of the wand swivel.

The swivel allows you to turn the handle to the left side to reach farther under low furniture.

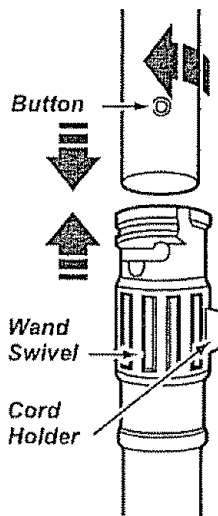

## POWER-MATE®

1. Insert wands into Power-Mate® until the wand buttons snaps into place.

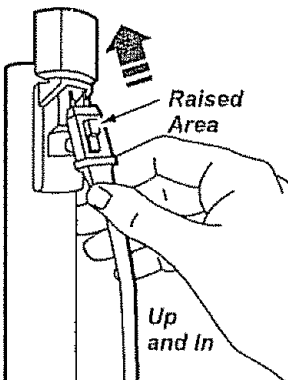

2. Connect Power-Mate® plug and cord as shown. **DO NOT** force. Raised area of plug must be toward hand.

3. Secure cord into cord holder on wand swivel.

**To remove:** Disconnect cord and step on wand release pedal, then pull up on wands.

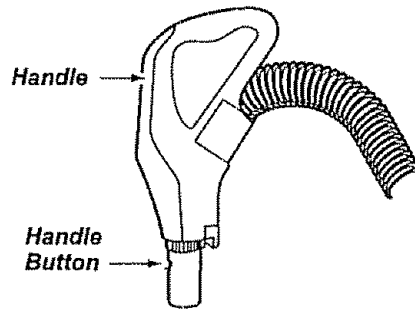

## POWER-MATE®

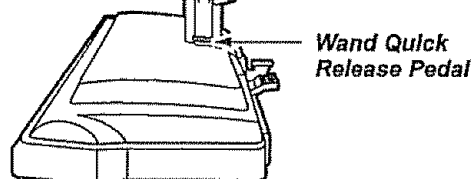
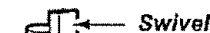

## CANISTER

1. Open the canister hood.
2. Check to see that the dust bag is properly installed. See BAG CHANGING for instructions.
3. Check to see that the motor safety filter is properly installed. See MOTOR SAFETY FILTER CLEANING for instructions.

## HOOD

It is normal for the canister hood to come off when opened further than needed. Line up the hinge slots, insert them, and close the hood to replace it.

## HOSE

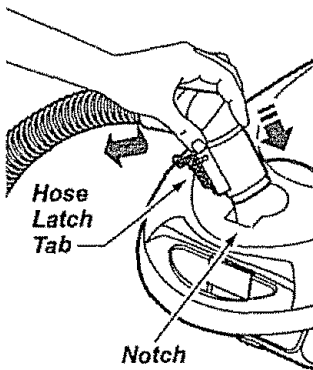

1. Line up the hose latch tab and notch in canister hood and insert hose into canister until it snaps in place.

**To remove:** Lift hose latch tab upward and pull up on hose.

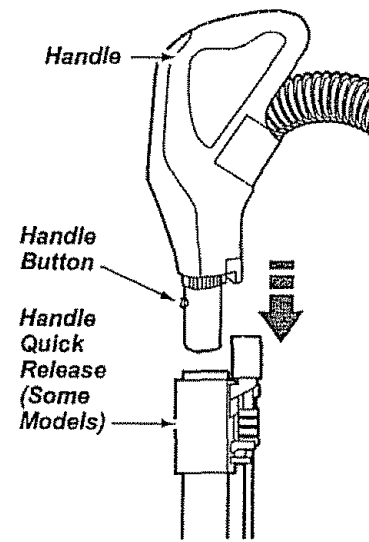
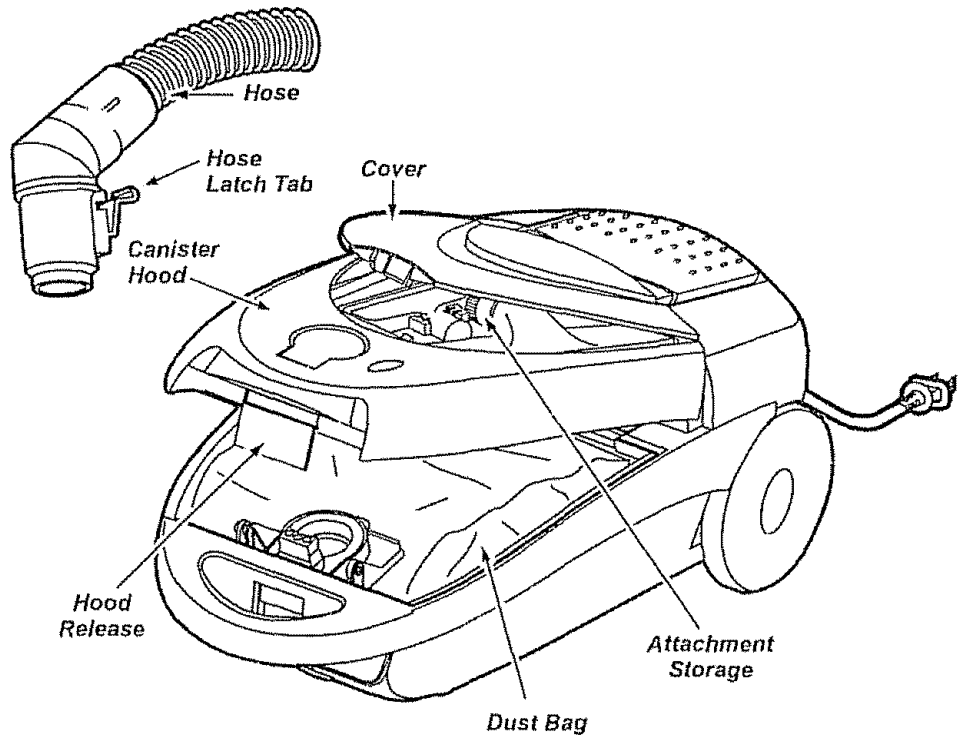

2. Insert handle into wand until lock button snaps in place. Be sure hose is not twisted.

**To remove:** Press handle release button and pull up on handle.

**To store:** Disconnect hose from wands and canister to prevent stress on hose during storage. Store hose in a loosely coiled position so the hose covering is not stressed.

## USE

### HOW TO START



#### WARNING

##### Personal Injury and Product Damage Hazard

- **DO NOT** plug in if switch is in ON position. Personal injury or damage could result.
- The cord moves rapidly when rewinding. Keep children away and provide a clear path when rewinding the cord to prevent personal injury.
- **DO NOT** use outlets above counters. Damage from cord to items in surrounding area could occur.

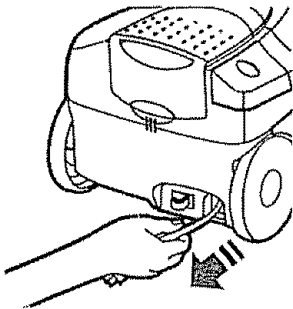

1. Pull cord out of canister to desired length. The cord will not rewind until the cord rewind button is pushed.

**NOTE:** To reduce the risk of electric shock, this vacuum cleaner has a polarized plug, one blade is wider than the other. This plug will fit in a polarized outlet only one way. If the plug does not fit fully in the outlet, reverse the plug. If it still does not fit, contact a qualified electrician to install the proper outlet. Do not change the plug in any way.

2. Plug the polarized power cord into a 120 Volt outlet located near the floor.

**To rewind:** Unplug the cleaner. Hold the plug while rewinding to prevent damage or injury from the moving cord. Push cord rewind bar.

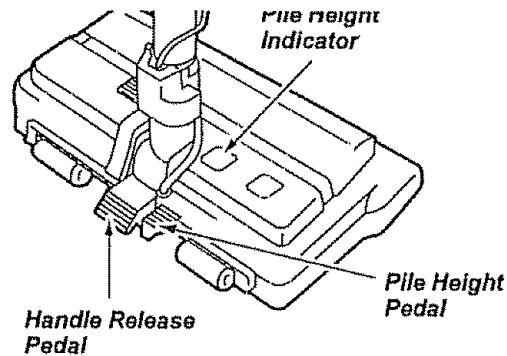

3. Lower wand from upright position by pressing on the handle release pedal.



#### CAUTION

**DO NOT** leave the Power-Mate® running in one spot in the upright position for any length of time. Damage to carpet may occur.

4. Select a pile height setting by pressing the small pedal on the rear of the Power-Mate®. The pile height setting shows on the indicator. See SUGGESTED PILE HEIGHT SETTINGS.

**Attention:** Refer to your carpet manufacturers cleaning recommendations. Some more delicate carpets may require that they be vacuumed with the Power-Mate® agitator turned off, to prevent carpet damage.

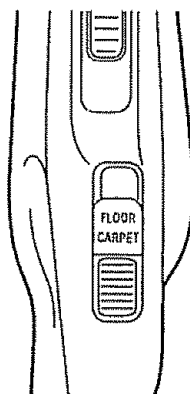

Select a switch position on the handle.

**OFF**

**FLOOR** - turns on the canister motor only

**CARPET** - turns on both the canister and the Power-Mate® motors.

## VACUUMING TIPS

### Suggested sweeping pattern.

For best cleaning action, the Power-Mate® should be pushed straight away from you and pulled straight back. At the end of each pull stroke, the direction of the Power-Mate® should be changed to point into the next section to be cleaned. This pattern should be continued across the rug with slow, gliding motions.

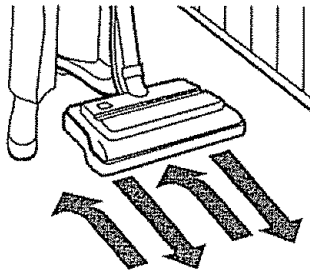

**NOTE:** Fast, jerky strokes do not provide complete cleaning.

The hose swivel allows the hose to turn without moving the canister. This is helpful for cleaning in small areas. Check hose for twisting before pulling canister.

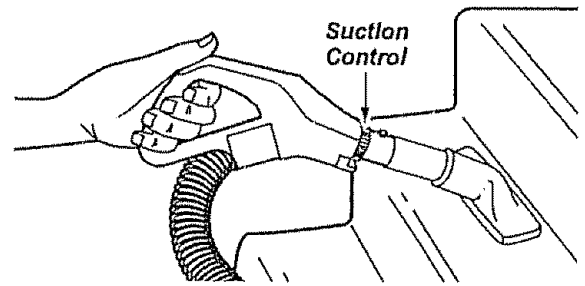
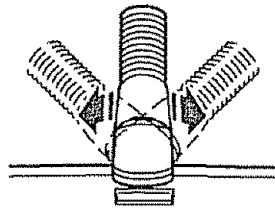

**Carpeted stairs** need to be vacuumed regularly. For best cleaning results, fully close the suction control.



### WARNING

**Personal Injury Hazard**

Use care if canister is placed on stairs. If it falls, personal injury or property damage could result.

For best cleaning results, keep the airflow passage open. Check each assembly area in HOW YOUR VACUUM WORKS occasionally for clogs. **Unplug from outlet before checking.**



### CAUTION

To prevent tip over, never leave Power-Mate® on or in the upright position. Turning the handle to one side will make the Power-Mate® more stable and less likely to tip over.

## SUGGESTED PILE HEIGHT SETTINGS

For best deep down cleaning, use the XLO setting. However, you may need to raise the height to make some jobs easier, such as scatter rugs and some deep pile carpets, and to prevent the vacuum cleaner from shutting off. Suggested settings are:

**HI** – Shag, deep pile, or scatter rugs.

**MED** – Medium to deep pile.

**LO** – Low to medium pile.

**XLO** – Most carpets and bare floors.

## ATTACHMENTS



### CAUTION

DO NOT attach or remove handle or wands while cleaner is ON. This could cause sparking and damage the electrical contacts.

### ATTACHMENTS ON HANDLE

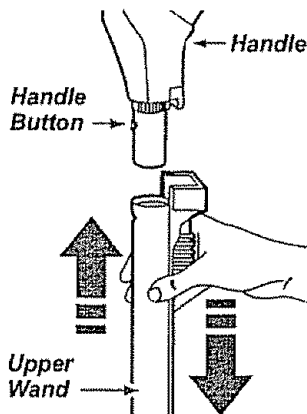

**NOTE:** If the Power-Mate® is attached, turn cleaner off before removing handle from wands.

1. Press lock button, then pull to remove handle from wand.

If your model has the optional feature of a handle release, press it in similarly.

2. Slide attachments firmly on handle as needed. See chart below.

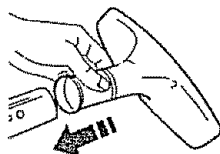

### ATTACHMENTS ON WANDS

1. To remove wands from Power-Mate®, lock wands in straight-up position.

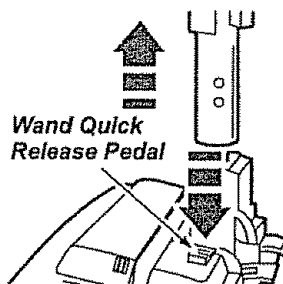
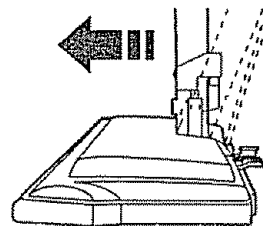



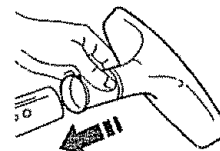

2. Press wand release pedal with foot and pull the wands straight up out of Power-Mate®.

The Power-Mate® plug and cord do not have to be removed to use attachments on the wands.

3. Put attachments on wands as needed. See chart below.

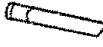

## ATTACHMENT USE CHART

ATTACHMENT	CLEANING AREA						
	Furniture*	Between Cushions*	Drapes*	Stairs	Bare Floors	Carpeted Floors/Rugs	Walls
Combination Brush (Some Models) 	X		X	X			X
Crevice Tool (Some Models) 	X	X					
Floor Brush (Some Models) 				X	X		X
Power-Mate® (Some Models) 					X***	X	
Handi-Mate Jr.® (Some Models)** 	X			X			
Power-Mate Jr.® (Some Models)** 	X			X			

\*Always clean attachments before using on fabrics \*\* 3-way On/Off switch should be in FLOOR position

\*\*\* Handi-Mate Jr.® and Power-Mate Jr.® attachment instructions are included with the products \*\*\* (Some Models) Power-Mate® switch should be in OFF position

**NOTE:** When separating wands, depress lock button completely before pulling wands apart. If wand lock button is difficult to depress, push the two wands more tightly together to line up the lock button with the hole. Depress lock button and then pull wands apart.

## PERFORMANCE FEATURES

### EDGE CLEANER

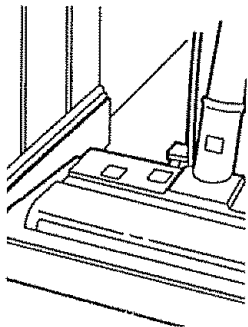

Active brush edge cleaners are on both sides of the Power-Mate®. Guide either side of the Power-Mate® along baseboards or next to furniture to help remove dirt trapped at carpet edges.

### OVERLOAD PROTECTOR

The Power-Mate® has built-in protection against motor and belt damage should the brush jam. If the brush slows down or stops, the overload protector button pops up and shuts off the Power-Mate®. The canister motor will continue to run.

**To correct problem:** See TROUBLESHOOTING.

**To reset:** Push in the overload protector button.

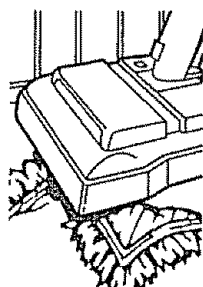

### SUCTION CONTROL

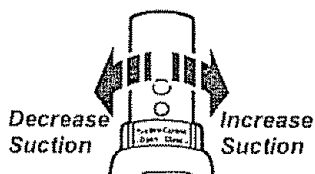

The suction control allows you to change the vacuum suction for different fabric

and carpet weights. Opening the control decreases suction for draperies and lightweight rugs, while closing the control increases suction for upholsteries and carpets.



### WARNING

#### Personal Injury Hazard

Always unplug the vacuum cleaner before cleaning the brush area as brush may suddenly restart. Failure to do so can result in personal injury.

### PERFORMANCE INDICATOR SOME MODELS

If the performance indicator turns entirely red check for a full dust bag, or a clog in the vacuum. See HOW YOUR VACUUM WORKS.

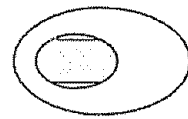

**NOTE:** The performance indicator may turn red when using attachments or when cleaning new carpet, due to reduced airflow by the attachments themselves or new carpet fuzz filling the bag quickly.

### POWER-MATE® STORAGE SOME MODELS

The lower wand has a "U" shaped flange in the area where the power cord attaches. The base has a "U" shaped slot near the front caster.

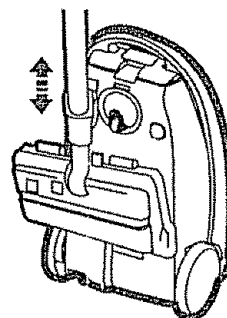

The slot allows the wands and Power-Mate® to be stored with the canister to conserve storage space. The canister must be stored on end for this feature to be used.

The wand will slip out of the slot as it is lifted up for use and will slide into the slot as it is lowered for storage.

### THERMAL PROTECTOR

This vacuum has a thermal protector which automatically trips to protect the vacuum from overheating. The thermal protector turns the motor off automatically to allow the motor to cool in order to prevent possible damage to the vacuum.

**To reset:** Turn off and unplug the vacuum from the outlet to allow the vacuum to cool. **Check for and remove any clogs. Also check and replace any clogged filters.** Wait approximately 50 minutes and plug the vacuum in and turn back on to see if the thermal protector has reset. In some cases, the unit may suddenly restart. **DO NOT** leave unattended.

## HOW YOUR VACUUM WORKS

The vacuum cleaner creates suction that picks up dirt. Rapidly moving air carries the dirt to the dust bag through the airflow passages. The dust bag lets the air pass through, while it traps the dirt.

For best cleaning results, keep the airflow passage open. Check the starred areas occasionally for clogs. Unplug from outlet before checking.

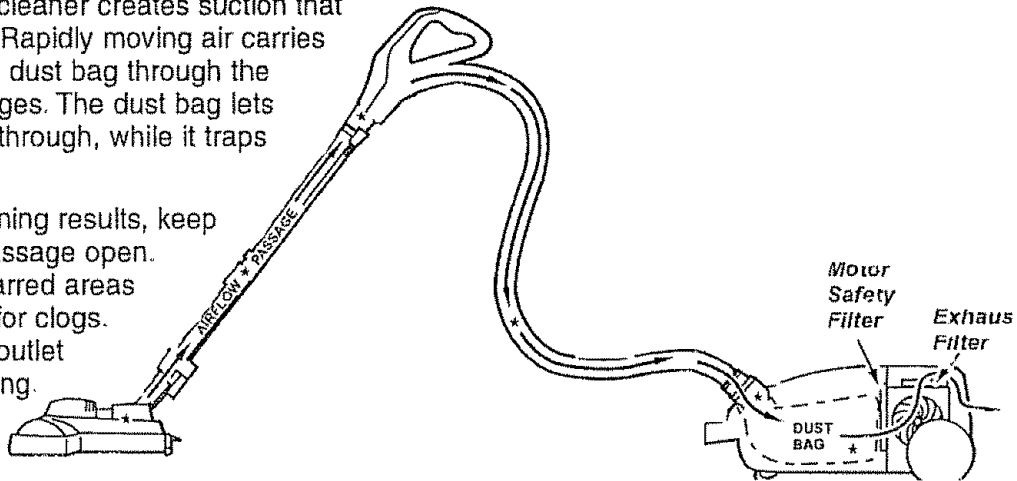

## CANISTER CARE

### BAG CHANGING

For best cleaning results, the dust bag should be changed often. The performance indicator (some models) will specify when the dust bag needs to be changed or the airflow is blocked. **NOTE:** See PARTS AND FEATURES for Bag Number.

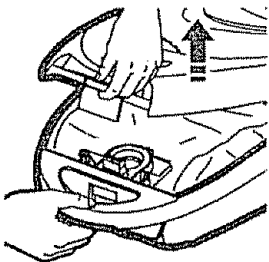

1. Unplug cord from wall outlet.
2. Remove hose from canister.
3. Pull hood release out and up, then lift canister hood.

4. Disengage cardboard tab from red bag mount by pulling away and lifting up.

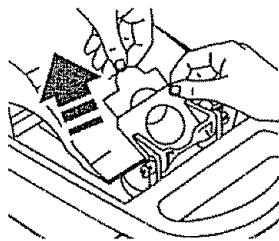

5. Pull bag out of the red bag mount.

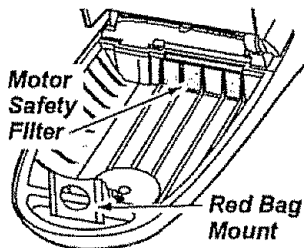

6. Check and replace, if necessary, the motor safety filter.

7. The red bag mount will flip forward after removing bag.

8. Rotate red bag mount down and install bag into slots per instructions pushing down until the cardboard tab locks into position and the holes align. Tuck the bag securely into the bag cavity so that none of it is able to be pinched by the hood.

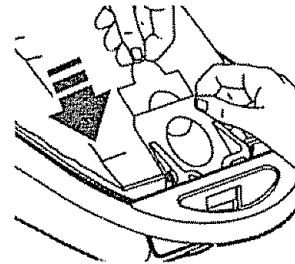

9. Replace and latch canister hood.
10. Insert hose into canister.
11. Plug cord into wall outlet.



### CAUTION

**NEVER REUSE A DUST BAG.** Very fine materials, such as carpet freshener, face powder, fine dust, plaster, soot, new carpet lint, etc. can clog the bag and cause it to burst before it is full and may cause damage to vacuum motor. Change bag more often when vacuuming these materials.

## CLEANING EXTERIOR AND ATTACHMENTS

1. Unplug cord from wall outlet. **DO NOT drip water on cleaner.**
2. Clean exterior using a clean, soft cloth that has been dipped in a solution of mild liquid detergent and water, then wrung dry. Wipe dry after cleaning.
3. To reduce static electricity and dust build-up, wipe outer surface of cleaner and attachments.



### CAUTION

Do not use attachments if they are wet. Attachments used in dirty areas, such as under a refrigerator, should not be used on other surfaces until they are washed. They could leave marks.

## MOTOR SAFETY FILTER CHANGING

Check motor safety filter occasionally and change when dirty.



### WARNING

#### Electrical Shock Hazard

Unplug power cord from electrical outlet. Do not operate the cleaner without the motor safety filter. Be sure the filter is dry and properly installed to prevent motor failure and/or electrical shock.

Remove the bag as outlined in the BAG CHANGING section.

### MOTOR SAFETY FILTER ELECTROSTATIC

This white and grey filter must be replaced when dirty. It should be replaced regularly depending on use conditions. **The filter CANNOT be washed** as it will lose its dust trapping ability.

1. Lift the rubber retainer and pull out motor safety filter as shown.

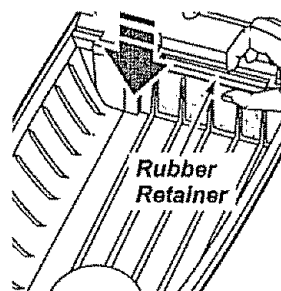
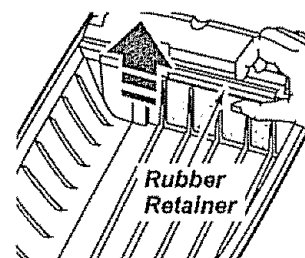

2. Replace the filter, **white side out**, by sliding it back into place under the ribs in the bag cavity. Tuck filter in so that it fits completely under the rubber retainer.

3. Replace the bag as outlined in the BAG CHANGING section.



### CAUTION

**NEVER REUSE A DUST BAG.** Very fine materials, such as carpet freshener, face powder, fine dust, plaster, soot, new carpet lint, etc. can clog the bag and cause it to burst before it is full. Change bag more often when vacuuming these materials.

## EXHAUST FILTER CHANGING



### WARNING

Fire and/or Electrical Shock Hazard  
Do not operate with a clogged exhaust filter or without the exhaust filter or exhaust filter cover installed.

### EXHAUST FILTER ELECTROSTATIC

The electrostatic filter must be replaced when dirty. Replace the filter when the entire surface area is covered evenly. The filter **CANNOT** be washed as it will lose its dust trapping ability.

Replacement exhaust filters are available through Sears Service Center under part no. 8175258. See "Requesting Assistance or Service"

1. Pull out and up on the exhaust filter cover to remove from the motor cover and lay aside.

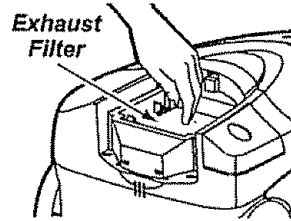
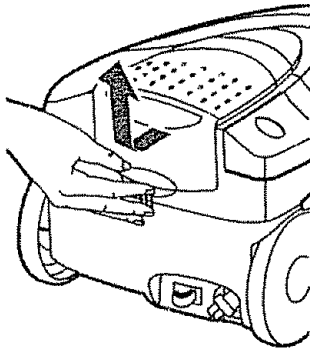

2. When the exhaust filter becomes dirty, remove it by pulling straight up.

3. Place the new filter into the motor cover with the white side down.

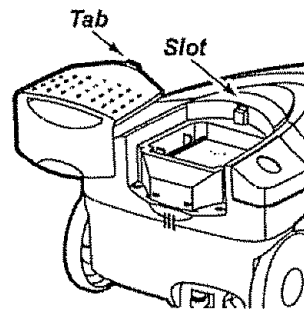
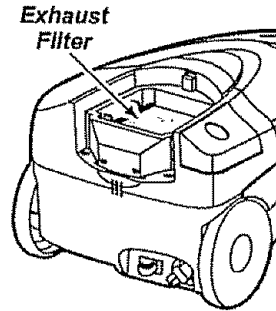

4. Reinstall the exhaust filter cover by inserting the tab into the slot in the motor cover. Press firmly to snap exhaust filter cover into place.

## POWER-MATE® CARE

Always follow all safety precautions when cleaning and servicing the Power-Mate®.



### WARNING

Electrical Shock Or Personal Injury Hazard

Disconnect electrical supply before servicing or cleaning the unit. Failure to do so could result in electrical shock or personal injury from cleaner suddenly starting.

## LIGHT BULB CHANGING

### HALF LIGHT POWER-MATE®

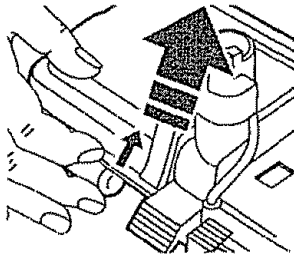

1. Remove light cover by lifting at arrow as shown.

2. Push in and turn bulb counterclockwise to remove.

3. Replace the bulb. Bulb must not be higher than 15 Watts (130V). Close light cover until it snaps in place.

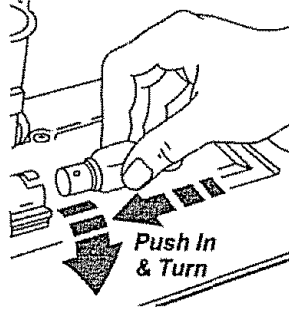

**NOTE:** See PARTS AND FEATURES for Bulb number.

### FULL LIGHT POWER-MATE®

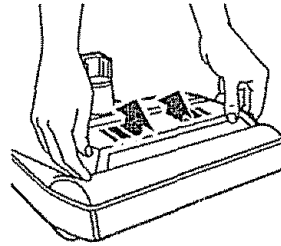

1. Remove light cover by pressing in and lifting both sides as shown.

2. Push in and turn bulb counterclockwise to remove.

3. Replace the bulb. Bulb must not be higher than 15 Watts (130V). Close light cover until it snaps in place.

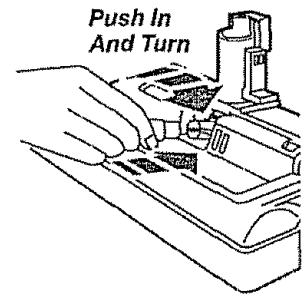

**NOTE:** See PARTS AND FEATURES for Bulb number.

## BELT CHANGING AND BRUSH CLEANING



### CAUTION

When you remove the end caps, a small metal washer on each end may come off. **DO NOT** lose these two metal washers.

#### TO CLEAN AGITATOR:

**NOTE:** In order to keep cleaning efficiency high and to prevent damage to your vacuum, the agitator must be cleaned every time the belt is changed.

The agitator must also be cleaned according to the following schedule:

<u>Vacuum Use</u>	<u>Clean Agitator</u>
<b>HEAVY</b> - (used daily)	every week
<b>MODERATE</b> - (used 2-3 times/week)	every month
<b>LIGHT</b> - (used 1 time/week)	every 2 months

Remove any dirt or debris in the belt path area or in the brush roller area.

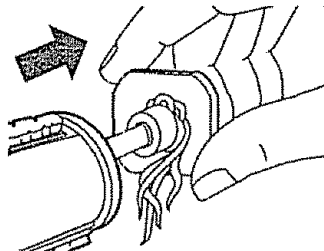

Carefully remove any string or debris located on the agitator, end caps, washers or agitator shaft.

### IMPORTANT

Replace the washers and the end caps. See the exploded view for correct assembly.

**Disconnect cleaner from electrical outlet.** Check and remove hair, string and lint build-up frequently in the Power-Mate® agitator and end cap areas. If build-up becomes excessive, disconnect Power-Mate® from wand and follow the steps below.

## TO REMOVE BELT

1. Remove light cover and light bulb as shown under LIGHT BULB CHANGING.

2. Unscrew the Power-Mate® cover screws.

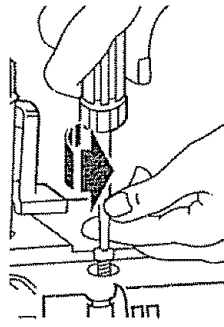

3. Turn Power-Mate® over. To remove cover, insert screwdriver at cover tabs on both sides and twist to release tabs.

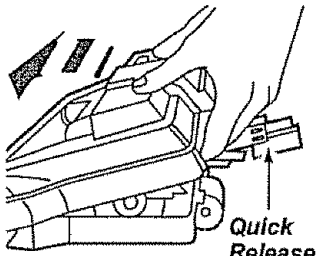
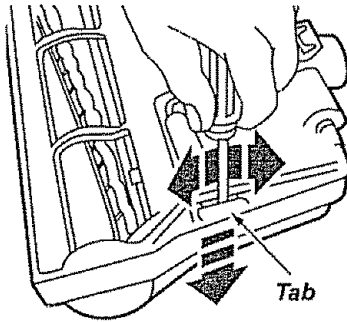

4. Turn Power-Mate® right side up. Press handle release pedal and lower the swivel. Rotate cover forward from back until front snaps free.

5. Carefully insert and lift screwdriver at each brush support to free brush from base.

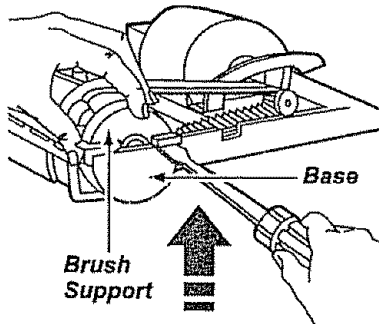

6. Remove worn belt.

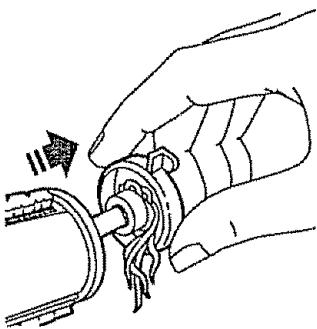

7. Slide brush supports off to check and clean brush support areas. See BRUSH ASSEMBLY for picture of complete brush assembly.

## TO REPLACE BELT

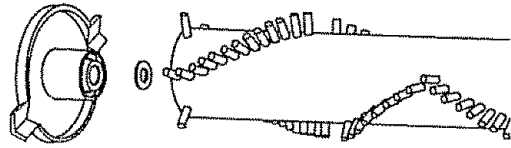

1. Slide washers and brush supports onto brush assembly.

2. Install new belt over motor drive, then over brush sprocket.

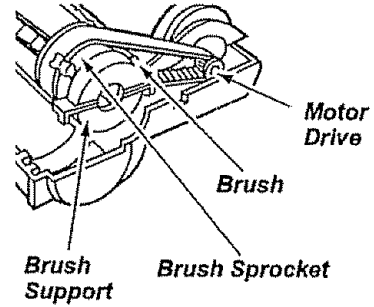

**NOTE:** See PARTS AND FEATURES for Belt number.

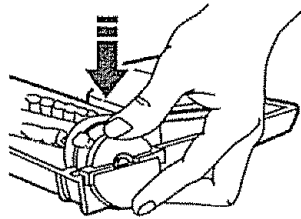

3. Snap brush supports into place on base. Be sure brush supports are not upside-down.

4. Line up front of cover and base. Rest cover on front edge of base as shown.

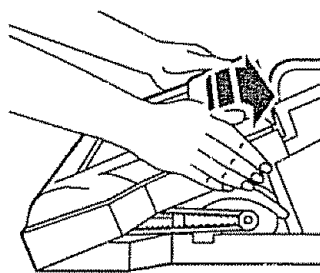
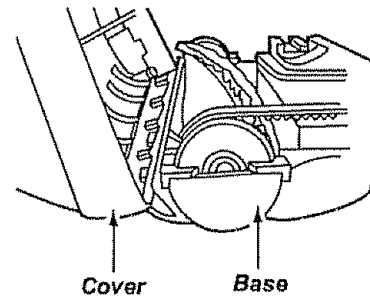

5. Rotate cover back. Press cover firmly until side tabs snap into place. Replace cover screws, light bulb and light cover.

## BRUSH SERVICING



### WARNING

Electrical Shock Or Personal Injury Hazard

Disconnect electrical supply before servicing or cleaning the unit. Failure to do so could result in electrical shock or personal injury from cleaner suddenly starting.

### TO CHECK BRUSHES

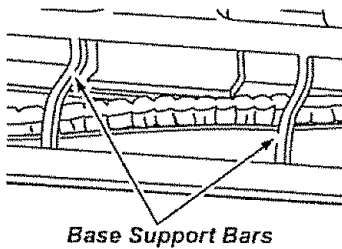

When brushes are worn to the level of the base support bars, replace the brush dowel.

### TO REPLACE BRUSH DOWEL

1. Remove Power-Mate® cover, belt and brush assembly. See "To Remove Belt" in BELT CHANGING AND BRUSH CLEANING.
2. Remove brush supports, washers, screws, end brush, brush sprocket pieces from ends of brush assembly.
3. Reassemble brush assembly. To line up screw holes in dowel, sprocket and end brush, be sure the brush portion of end brush lines up with brushes on brush dowel.
4. Replace belt, brush assembly, Power-Mate® cover, light bulb and light cover. See "To replace belt" in BELT CHANGING AND BRUSH CLEANING.

## BRUSH ASSEMBLY

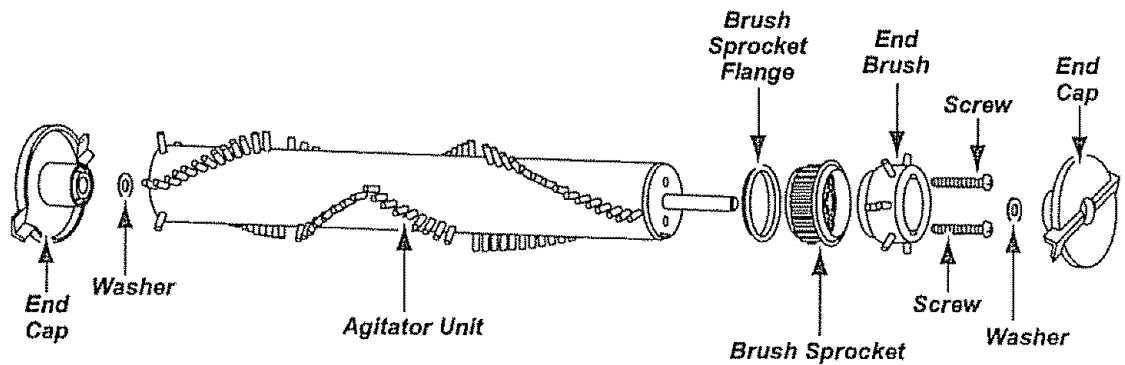

## TROUBLESHOOTING

Review this chart to find do-it-yourself solutions for minor performance problems. Any service needed, other than those described in this owner's manual, should be performed by a Sears authorized service representative.



### **WARNING** Electrical Shock Hazard

**Disconnect electrical supply before servicing or cleaning the unit. Failure to do so could result in electrical shock or personal injury.**

PROBLEM	POSSIBLE CAUSE	POSSIBLE SOLUTION
Cleaner won't start.	<ol style="list-style-type: none"> <li>1. Unplugged at wall outlet</li> <li>2. Tripped circuit breaker/blown fuse at household service panel.</li> <li>3. Loose hose electrical connections</li> <li>4. Tripped thermal protector in canister.</li> </ol>	<ol style="list-style-type: none"> <li>1. Plug in firmly, push ON/OFF switch to ON.</li> <li>2. Reset circuit breaker or replace fuse</li> <li>3. Reconnect hose ends, (page 7)</li> <li>4. Reset thermal protector, (page 11)</li> </ol>
Poor job of dirt pick-up.	<ol style="list-style-type: none"> <li>1. Full or clogged dust bag.</li> <li>2. Clogged airflow passages</li> <li>3. Dirty filters</li> <li>4. Wrong pile height setting</li> <li>5. Open suction control</li> <li>6. Hole in hose</li> <li>7. Worn Power-Mate® brushes</li> <li>8. Worn or broken belt</li> <li>9. Dirty brush or brush supports</li> <li>10. Canister hood open</li> </ol>	<ol style="list-style-type: none"> <li>1. Change bag, (page 13).</li> <li>2. Clear airflow passages, (page 13).</li> <li>3. Clean/change filters, (page 14, 15)</li> <li>4. Adjust setting, (page 9)</li> <li>5. Adjust control, (page 12)</li> <li>6. Replace hose</li> <li>7. Change brushes, (page 18).</li> <li>8 &amp; 9. See BELT CHANGING AND BRUSH CLEANING, (pages 16, 17).</li> <li>10. Close and latch hood</li> </ol>
Cleaner starts but cuts off.	<ol style="list-style-type: none"> <li>1. Hose or hood electrical connections</li> <li>2. Tripped overload protector in Power-Mate®</li> <li>3. Tripped thermal protector in canister</li> </ol>	<ol style="list-style-type: none"> <li>1. Check connections, reconnect hose ends, (page 7)</li> <li>2. Remove any items that may be caught or jammed, then reset. If cleaner starts and stops again, clean brush and brush supports, then reset, (pages 16, 17).</li> <li>3. Reset thermal protector, (page 11)</li> </ol>
Power-Mate® will not run when attached.	<ol style="list-style-type: none"> <li>1. Power-Mate® connections unplugged</li> <li>2. Worn or broken belt</li> <li>3. Dirty brush or brush supports</li> <li>4. Tripped overload protector in Power-Mate™</li> </ol>	<ol style="list-style-type: none"> <li>1. Plug in firmly, (page 6).</li> <li>2 &amp; 3. See BELT CHANGING AND BRUSH CLEANING, (pages 16, 17).</li> <li>4. Check brush area for excessive lint build-up or jamming. Clean brush and brush supports, then reset, (pages 16, 17).</li> </ol>
Performance indicator, some models, is red.	<ol style="list-style-type: none"> <li>1. Full or clogged dust bag</li> <li>2. Dirty filters</li> <li>3. Clogged airflow passage</li> <li>4. Certain attachment tools</li> </ol>	<ol style="list-style-type: none"> <li>1. Change bag, (page 13).</li> <li>2. Clean/change filters, (page 14, 15)</li> <li>3. Clear clog from airflow passage, (page 13).</li> <li>4. This is normal. Red should disappear when tool is removed</li> </ol>
Cleaner picks up moveable rugs -or- Power-Mate® pushes too hard.	<ol style="list-style-type: none"> <li>1. Wrong pile height setting</li> <li>2. Suction too strong</li> </ol>	<ol style="list-style-type: none"> <li>1. Adjust setting, (page 9)</li> <li>2. Open suction control, (page 16)</li> </ol>
Light won't work.	<ol style="list-style-type: none"> <li>1. Burned out light bulb</li> </ol>	<ol style="list-style-type: none"> <li>1. Change light bulb, (page 16)</li> </ol>
Cord won't rewind.	<ol style="list-style-type: none"> <li>1. Dirty power cord.</li> <li>2. Cord jammed</li> </ol>	<ol style="list-style-type: none"> <li>1. Clean the power cord.</li> <li>2. Pull out cord and rewind</li> </ol>
Cleaner leaves marks on carpet.	<ol style="list-style-type: none"> <li>1. Wrong vacuuming pattern</li> </ol>	<ol style="list-style-type: none"> <li>1. See VACUUMING TIPS, (page 9)</li> </ol>

# Get it fixed, at your home or ours!

For repair of major brand appliances **in your own home . . .**  
no matter who made it, no matter who sold it!

**1-800-4-MY-HOME<sup>®</sup>** Anytime, day or night  
(1-800-469-4663) (U.S.A. and Canada)  
[www.sears.com](http://www.sears.com) [www.sears.ca](http://www.sears.ca)

For repair of carry-in products like vacuums, lawn equipment, and  
electronics, call for the nearest **Sears Parts and Repair Center.**

**1-800-488-1222** Anytime, day or night (U.S.A. only)  
[www.sears.com](http://www.sears.com)

For the replacement parts, accessories and owner's manuals  
that you need to do-it-yourself, call **Sears PartsDirect<sup>SM</sup>**!

**1-800-366-PART** 6 a.m. – 11 p.m., 7 days a week  
(1-800-366-7278) (U.S.A. only)  
[www.sears.com/partsdirect](http://www.sears.com/partsdirect)

To purchase or inquire about a Sears Service Agreement  
or Sears Maintenance Agreement:

**1-800-827-6655** (U.S.A.) **1-800-361-6665** (Canada )  
7 a.m. – 5 p.m., CST, Mon. – Sat. 9 a.m. – 8 p.m. EST, M – F, 4 p.m. Sat.

Para pedir servicio de reparación a  
domicilio, y para ordenar piezas:  
**1-888-SU-HOGAR<sup>SM</sup>**  
(1-888-784-6427)

Au Canada pour service en français:  
**1-800-LE-FOYER<sup>MC</sup>**  
(1-800-533-6937)  
[www.sears.ca](http://www.sears.ca)



© Sears, Roebuck and Co.

® Registered Trademark / <sup>TM</sup> Trademark / <sup>SM</sup> Service Mark of Sears, Roebuck and Co.

® Marca Registrada / <sup>TM</sup> Marca de Fábrica / <sup>SM</sup> Marca de Servicio de Sears, Roebuck and Co.

<sup>MC</sup> Marque de commerce / <sup>MD</sup> Marque déposée de Sears, Roebuck and Co.