

This Owner's Manual is provided and hosted by [Appliance Factory Parts](#).

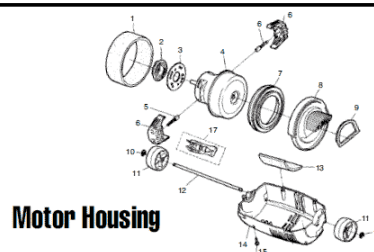

PANASONIC 662 Owner's Manual

[Shop genuine replacement parts for PANASONIC 662](#)

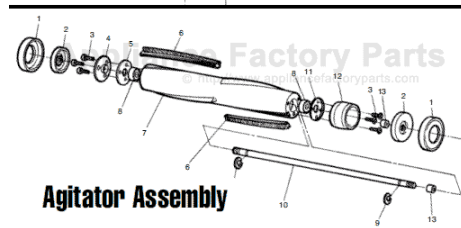
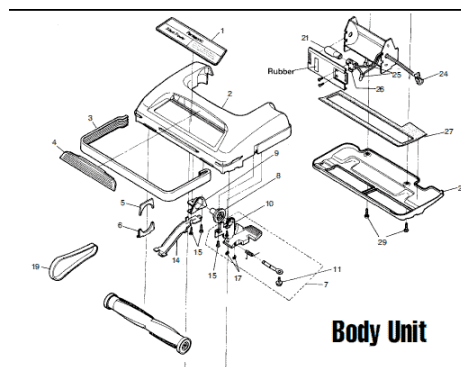

[Find Your PANASONIC Vacuum Cleaner Parts - Select From 605 Models](#)

----- Manual continues below -----

PANASONIC

Models: MC-661, MC-662, MC-663, MC-671, MC-672

Body Unit

1	N/A	Nameplate, 661,671
1	N/A	Nameplate, 662,672
2	N/A	Nozzle Housing, 661,671
2	N/A	Nozzle Housing, 662,663,672
3	P-107	Furniture Guard
4	P-217	Lens, 661,671
4	P-218	Lens, 662,663,672
5	P-005	Agitator Holder, upper, w/o clip
6	P-050	Agitator Holder, lower, w/o clip
7	P-807	Pedal Assembly
8	P-257	Bearing, plastic agitator holder
9	P-787	Bearing, metal holder
10	P-437	Frame, pedal assy holder
11	P-516	Screw, long, foot pedal
14	P-4300	Belt Cover
15	P-416	Screw, 10 pk
17	P-05	E-Clip, pedal shaft, 30 pk
19	P-2287	Belt, type "UB", 2 pack
19	P-200	Belt, sold ea (R)
21	MP-25K	Bulb, 662,663,672 (R)
24	SS-34	Cord Lock Bushing, sold ea (R)
25	SS-71B	Wire Nut, 100 pack (R)
26	N/A	Lamp Holder, 662,663,672
27	P-197	Body Packing, gasket, bottom plate
28	P-277	Bottom Plate
29	P-20	Screw, bottom plate

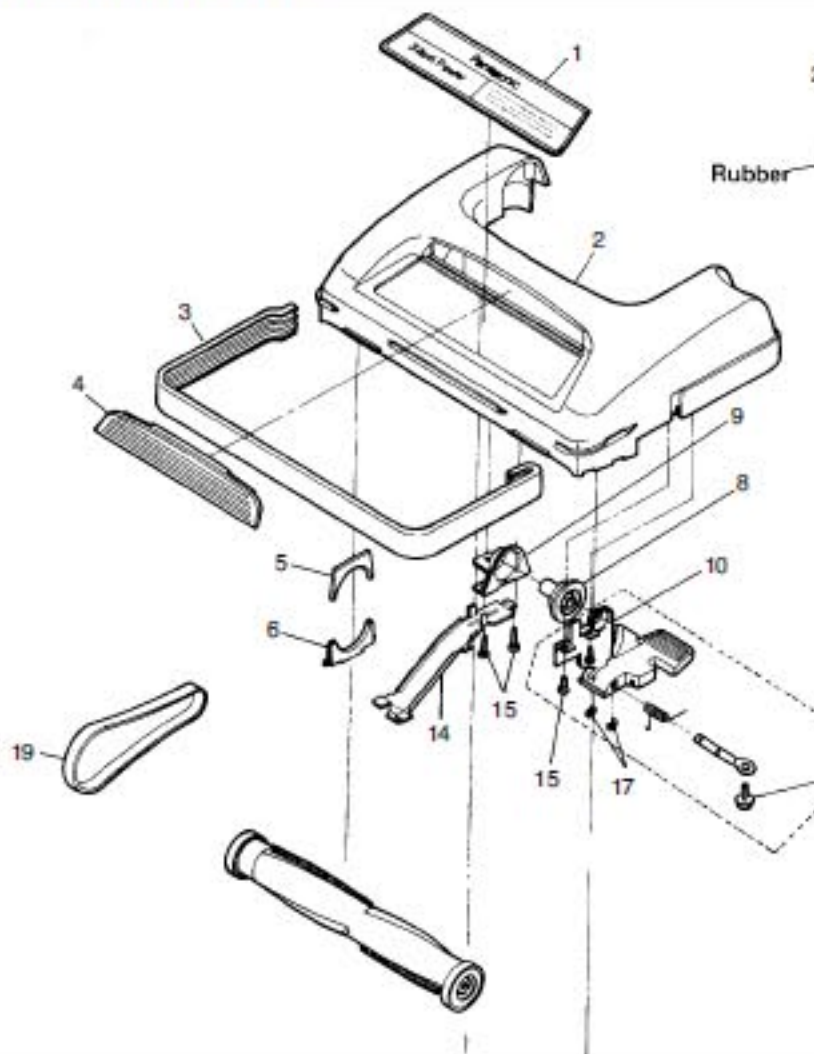

Agitator Assembly

1	P-41000	End Cover, rubber
2	P-970	End Cap
3	P-38	Screw
4	P-540	End Plate
5	P-300	Filter, agitator bearing
6	N/A	Brush Strip
6	N/A	Brush Strip, (R)
7	P-840	Agitator Shell Only
8	P-350	Bearing, agitator
9	P-05	E-Clip, agitator shaft, 30 pk
10	P-570	Shaft
11	P-600	Pulley, metal cap
12	P-290	Pulley, plastic
13	P-3340	End Spacer, pulley
	P-920	Agitator Complete

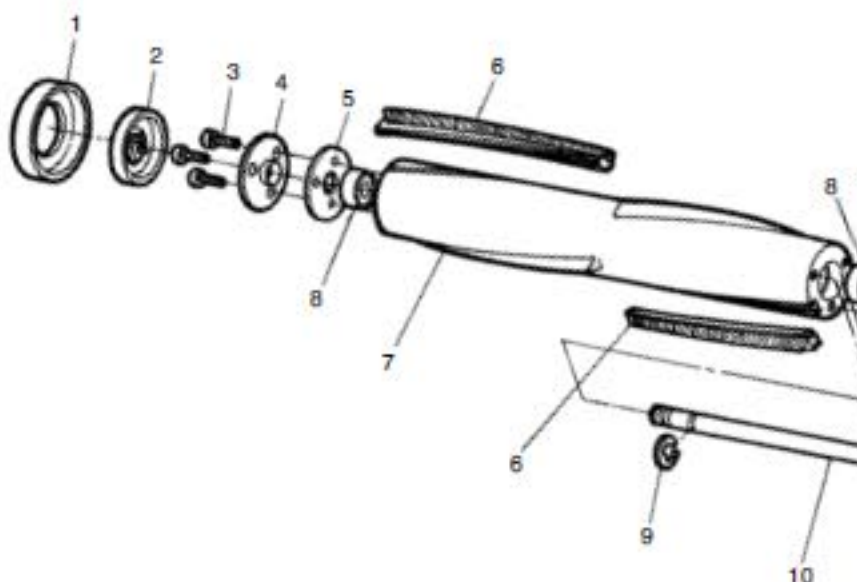

Motor Housing

1	P-9920	Noise Suppressor
2	P-037	Motor Support, rubber
3	P-6370	Motor Cover
4	P-0117	Motor, 661,662,671,672
4	P-119	Motor, 663
5	P-272	Carbon Brush, w/ spring

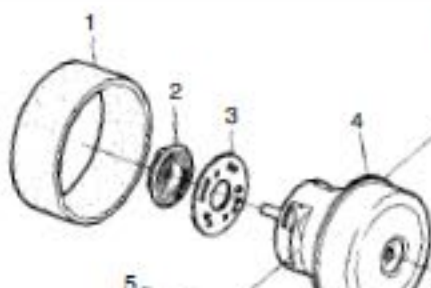

PANASONIC

Models: MC-661, MC-662, MC-663, MC-671, MC-672

Bag Housing

1	P-115P	Paper Bag, type "U", 3 pack
1	P-115PT	Paper Bag, type "U", 12 pack
1	253	Paper Bag, type "U", 3 pack (R)
1	253-12	Paper Bag, type "U", 12 pack (R)
1	MF-11	Paper Bag, type "U", microfiltration, 3 pk (R)
	P-9923	Cloth Bag, slide, blue/green
	P-55	Cloth Bag, zipper (R)
2	P-672	Cover, bag housing, 661,671
8	P-17	Bag Lock Knob, front housing
9	P-1034	Bag Support
10	P-747	Gasket, bag housing
11	SS-34	Cord Lock, sold each (R)
12	P-413	Screw
13	P-137	Holder, paper bag
14	P-416	Screw, 10 pk
15	P-958	Handle
16	SS-34	Cord Lock, sold each (R)
17	MP-225	Cord, 20 ft, white (R)
17	MP-230	Cord, 30 ft, white (R)
18	P-73000	Screw, handle support
19	P-647	Gasket, suction inlet
20	P-607	Suction Inlet
21	N/A	Cover, suction inlet
22	N/A	Hose, suction inlet
23	N/A	Bag Housing
24	P-307	Filter
26	P-247	Inlet Hose Fitting
28	P-3470	Spacer
30	P-116	Ornamental Plate
31	P-3120	Screw Plate

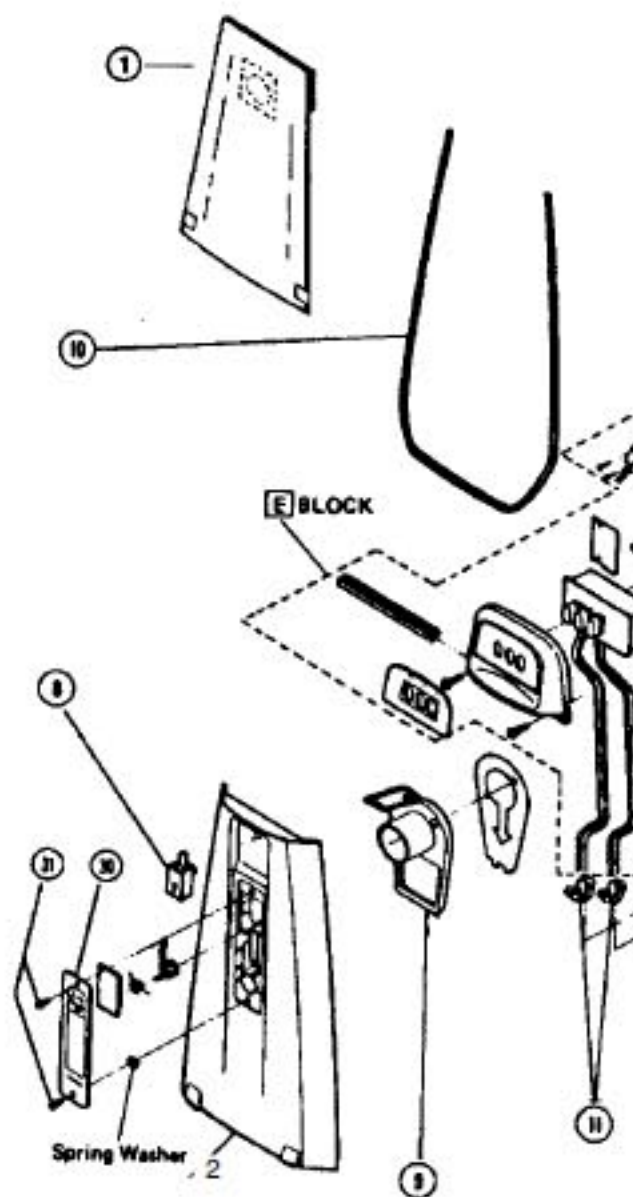

Power Control Switch

1	P-416	Screw, 10 pk
3	P-7377	Upper Gasket, bag housing
5	P-416	Screw, 10 pk
6	P-697	Handle Support Fitting
7	P-537	Handle Support
10	P-987	Switch, on / off
11	P-157	Switch Lever, on / off
12	SS-71B	Wire Nut, 100 pack (R)
15	P-4570	Terminal Cover
	N/A	Power Control Switch

