

This Owner's Manual is provided and hosted by [Appliance Factory Parts](http://www.appliancefactoryparts.com).

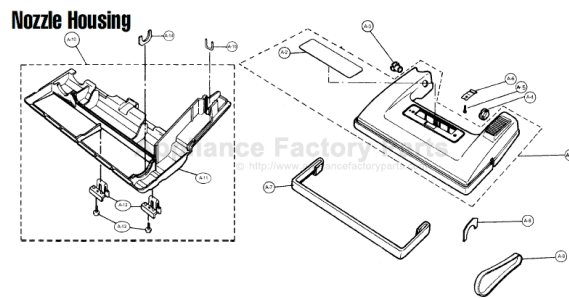

PANASONIC 5177 Owner's Manual

[Shop genuine replacement parts for PANASONIC 5177](#)



[Find Your PANASONIC Vacuum Cleaner Parts - Select From 605 Models](#)

----- Manual continues below -----

PANASONIC

Models: MC-5107, MC-5117, 5157, 5167, 5177

Nozzle Housing

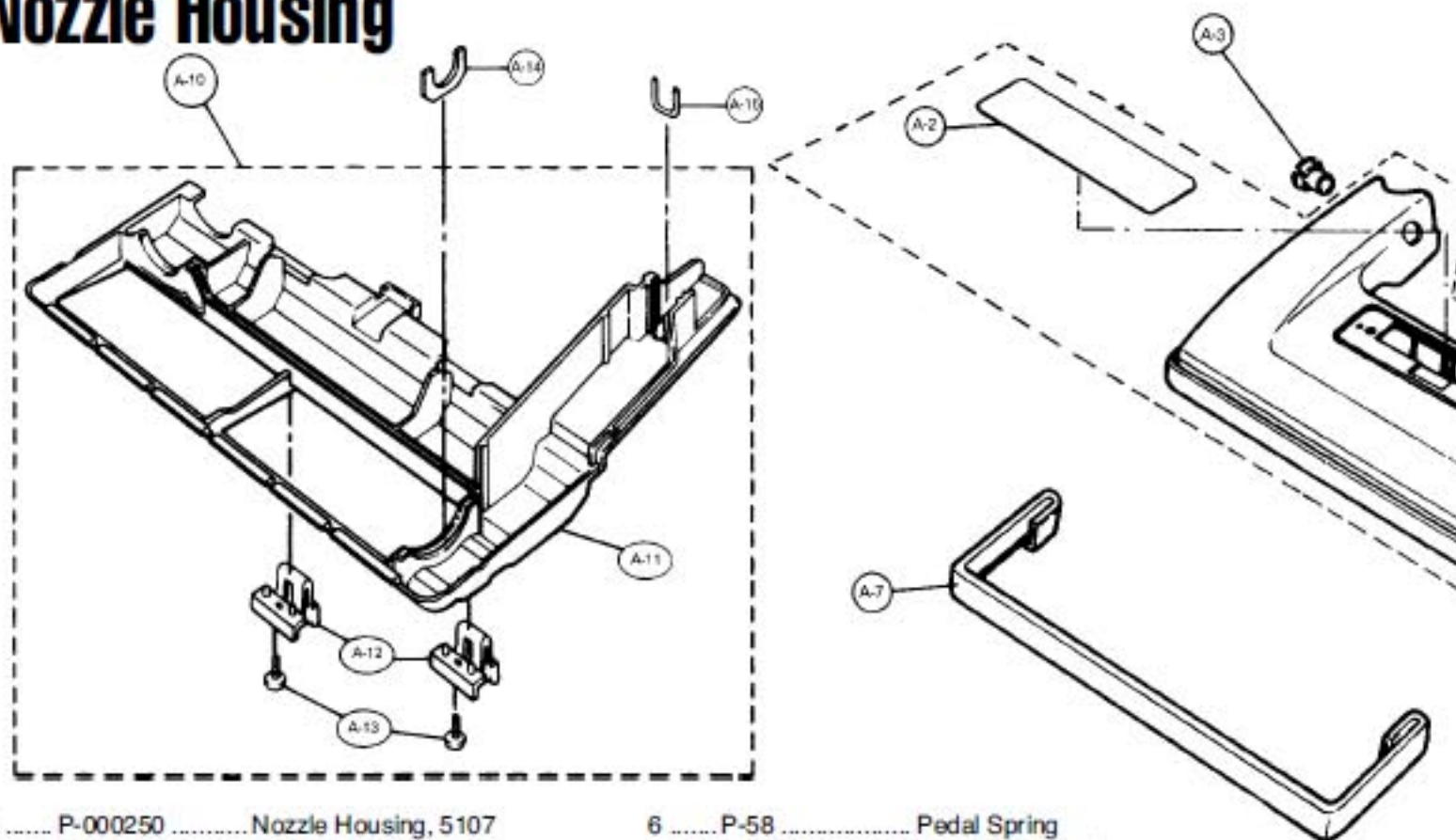

- 1 P-000250 Nozzle Housing, 5107
- 1 P-000098 Nozzle Housing, 5117
- 1 P-000264 Nozzle Housing, 5157
- 1 P-000093 Nozzle Housing, 5167
- 1 P-000265 Nozzle Housing, 5177
- 2 P-00200 Top Mark, 5107
- 2 N/A Top Mark, 5117
- 2 P-000266 Top Mark, 5157
- 2 P-000238 Top Mark, 5167
- 2 P-000267 Top Mark, 5177
- 3 P-2500 Plastic Shaft
- 4 P-78 Plastic Holder
- 5 P-000132 Screw, 5107
- 5 P-000100 Screw, 5117
- 5 P-000132 Screw, 5157, 5167, 5177

- 6 P-58 Pedal Spring
- 7 P-000251 Furniture Guard, 5107
- 7 P-1000 Furniture Guard, 5117, 5167
- 7 P-00057 Furniture Guard, 5157, 5177
- 8 P-000101 Tight Packing
- 9 P-2287 Belt, type UB, 2 pack
- 9 P-200 Belt, sold each (R)
- 10 P-91 Bottom Plate, complete
- 10 P-000268 Bottom Plate, complete, 5157
- 10 P-9101 Bottom Plate, complete, 5167
- 10 P-000269 Bottom Plate, complete, 5177
- 11 P-000102 Bottom Plate Only, 5107, 5117
- 11 P-000239 Bottom Plate Only, 5167
- 12 P-000103 Latch
- 12 P-0800 Latch, 5157, 5167, 5177

- 13 P-000
- 13 P-000
- 13 P-000
- 14 P-750
- 15 P-430
- 15 P-43

Agitator Assemblies

MC-5107

MC-5117,

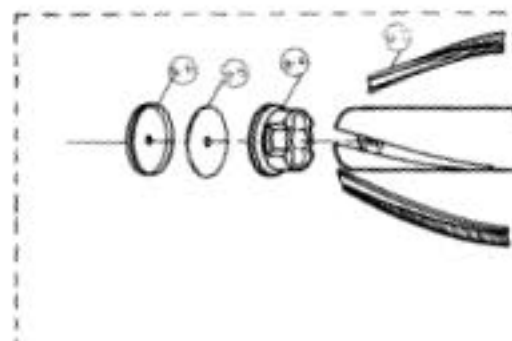
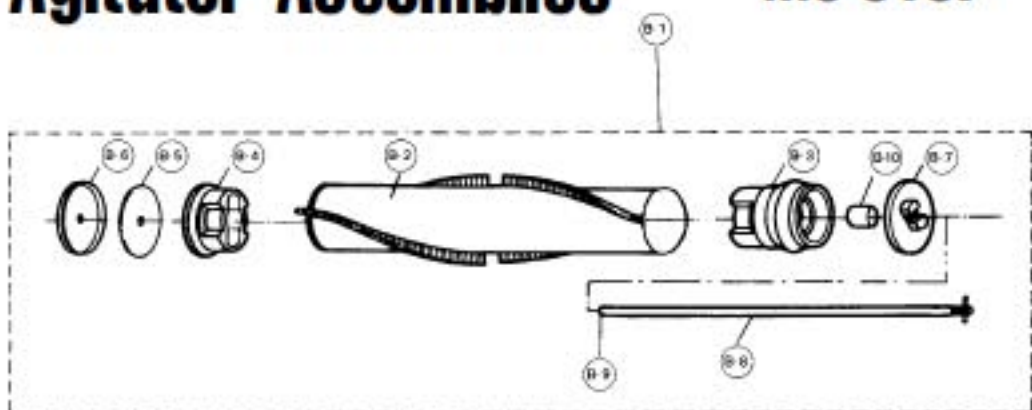

- 1 P-9 Agitator Assembly, 5107
- 1 P-510 Agitator Assembly, complete (R)
- 2 P-84 Agitator Body

- 1 P-921 Agitator Assembly
- 1 P-510 Agitator Assembly
- 2 P-85 Brush, 4 pcs

PANASONIC

Models: MC-5107, MC-5117, MC-5157, MC-5167, MC5177

Motor Housing

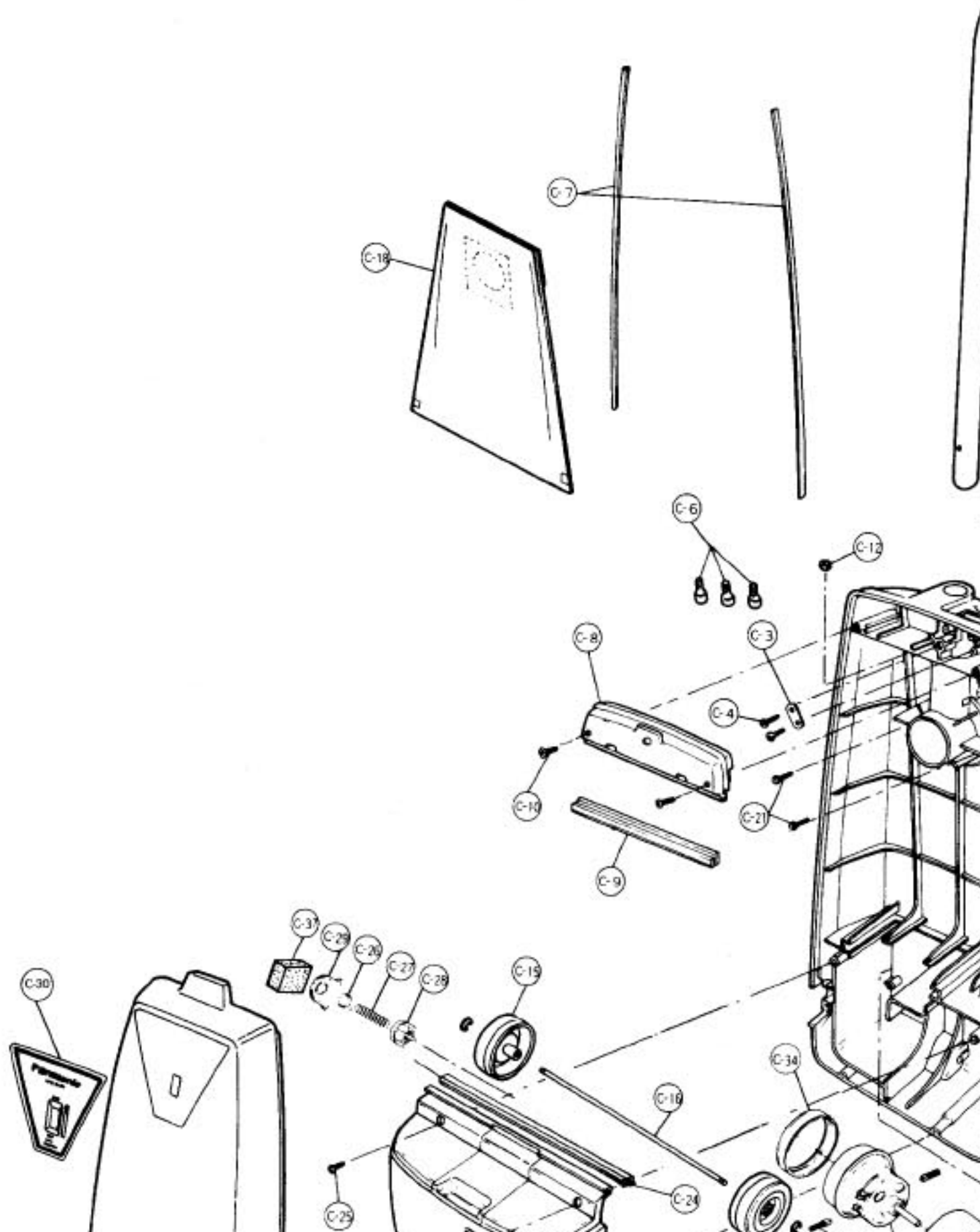

PANASONIC

Models: MC-5107, MC-5117, MC-5157, MC-5167, MC5177

1	P-4022	Dust Compartment, 5107	29	P-000058	Protector Su
1	P-4004	Dust Compartment, 5117	30	P-000254	Ornamental
1	P-000097	Dust Compartment, 5157, 5167, 5177	30	P-000105	Ornamental
2	P-8913	On/Off Switch		P-000241	Vac Gauge
3	P-0698	Cord Stopper	31	P-926	Motor Assen
3	N/A	Cord Stopper, 5157, 5167, 5177	31	P-000144	Motor Assen
4	P-000132	Screw, 5107	32	P-272	Carbon Brus
4	P-000100	Screw, 5117	32	P-0035	Carbon Brus
4	P-00132	Screw, 5157, 5167, 5177	32	P-10393	Carbon Brus
5	P-000252	Power Cord, 5107		P-0036	Bracket, bru
5	N/A	Power Cord, 5117	33	P-99300	Noise Suppr
5	P-000078	Power Cord, 5157, 5167, 5177	34	P-0293	Motor Suppr
6	P-000623	Wire Connector	35	P-9911	Motor Suppr
7	P-66	Rubber Gasket	36	P-377	Wire Cord
8	P-0307	Switch Cover, 5107	36	P-37020	Wire Cord, 5
8	P-003	Switch Cover, 5117	37	P-333	Protector Fil
8	P-0302	Switch Cover, 5157, 5177	38	P-000255	Handle, 510
8	P-000141	Switch Cover, 5167	38	P-000106	Handle, 511
9	P-73	Rubber Gasket	38	P-000270	Handle, incl
10	P-000132	Screw, 5107	38	P-64200	Handle, 516
10	P-000100	Screw, 5117	39	P-5332	Upper Cord
10	P-000132	Screw, 5157, 5167, 5177	39	P-53007	Upper Cord
11	P-7301	Handle Screw	39	P-000243	Upper Cord
12	P-2117	Nut	40	P-5505	Cord Hook,
13	P-3200	Filter Supporter	40	P-55007	Cord Hook,
14	P-375	Secondary Filter	40	P-000244	Cord Hook,
14	P-9829	Secondary Filter, electrostatic, 5157, 5177	41	P-7670	Cord Hook S
15	P-161	Roller, 5107	42	P-587	Washer
15	P-0107	Roller, 5117	43	P-5404	Lower Cord
15	P-0114	Roller, 5157, 5167, 5177	43	P-54007	Lower Cord
16	P-161	Roller Shaft	43	P-000245	Lower Cord
17	P-05	E-Clip	44	P-430	Screw
17	N/A	E-Clip, 5157, 5167, 5177	45	P-000256	Dust Cover,
18	P-115P	Paper Bag, type U3, 3 pack	45	P-000107	Dust Cover,
18	P-115PT	Paper Bag, type U3, 12 pack	45	P-000246	Dust Cover,
18	253	Paper Bag, 3 pack (R)	45	P-000160	Dust Cover,
18	253-12	Paper Bag, 12 pack (R)	45	P-000247	Dust Cover,
18	MF-11	Paper Bag, 3 pack, micro-filtration (R)	46	P-000108	Lead Wire
19	P-6078	Suction Inlet, 5107	47	P-3407	Nozzle Hose
19	P-60704	Suction Inlet, 5117	47	P-34	Nozzle Hose
19	P-000138	Suction Inlet, 5157, 5167, 5177	47	P-000140	Nozzle Hose
20	P-0276	Cover, 5107		P-9300	Indicator Pa
20	P-02704	Cover, 5117		P-000147	Indicator Ca
20	P-000139	Cover, 5157, 5167, 5177		P-000148	Indicator Sp
21	P-000132	Screw, 5107		P-000149	Indicator Le
21	P-000100	Screw, 5117		P-000150	Indicator Bo
21	P-000132	Screw, 5157, 5167, 5177		P-4100	Oversized R
22	P-000253	Motor Case, 5107		P-000272	Oversized F
22	P-09004	Motor Case, 5117		P-0037	Motor Brush
22	P-000253	Motor Case, 5157, 5167, 5177		P-000272	Motor Brush