

This Owner's Manual is provided and hosted by [Appliance Factory Parts](#).

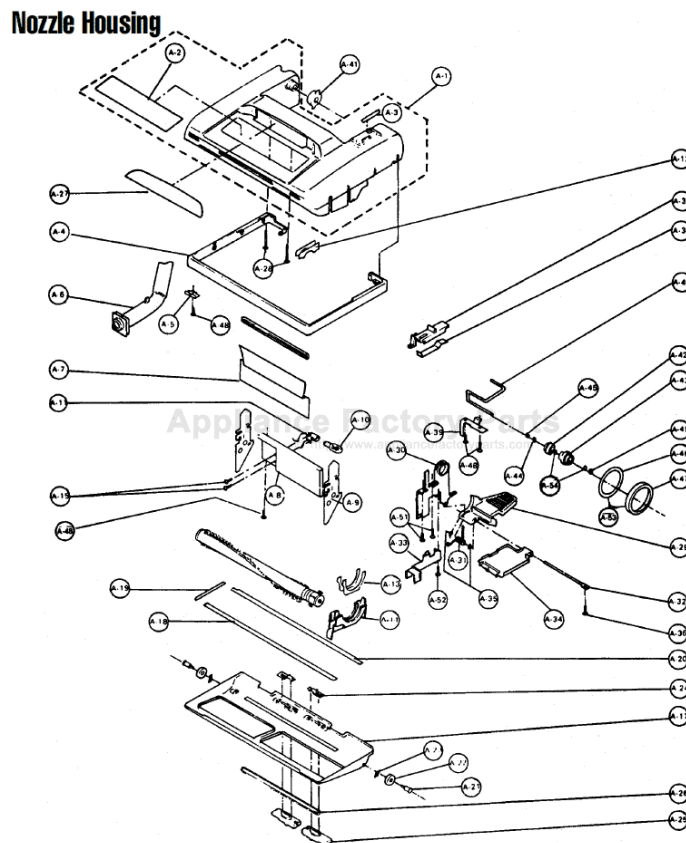

PANASONIC 6230 Owner's Manual

[Shop genuine replacement parts for PANASONIC 6230](#)



[Find Your PANASONIC Vacuum Cleaner Parts - Select From 605 Models](#)

----- Manual continues below -----

PANASONIC

Models: MC-6210, MC-6215, MC-6220, MC-6225, MC-6230

Nozzle Housing

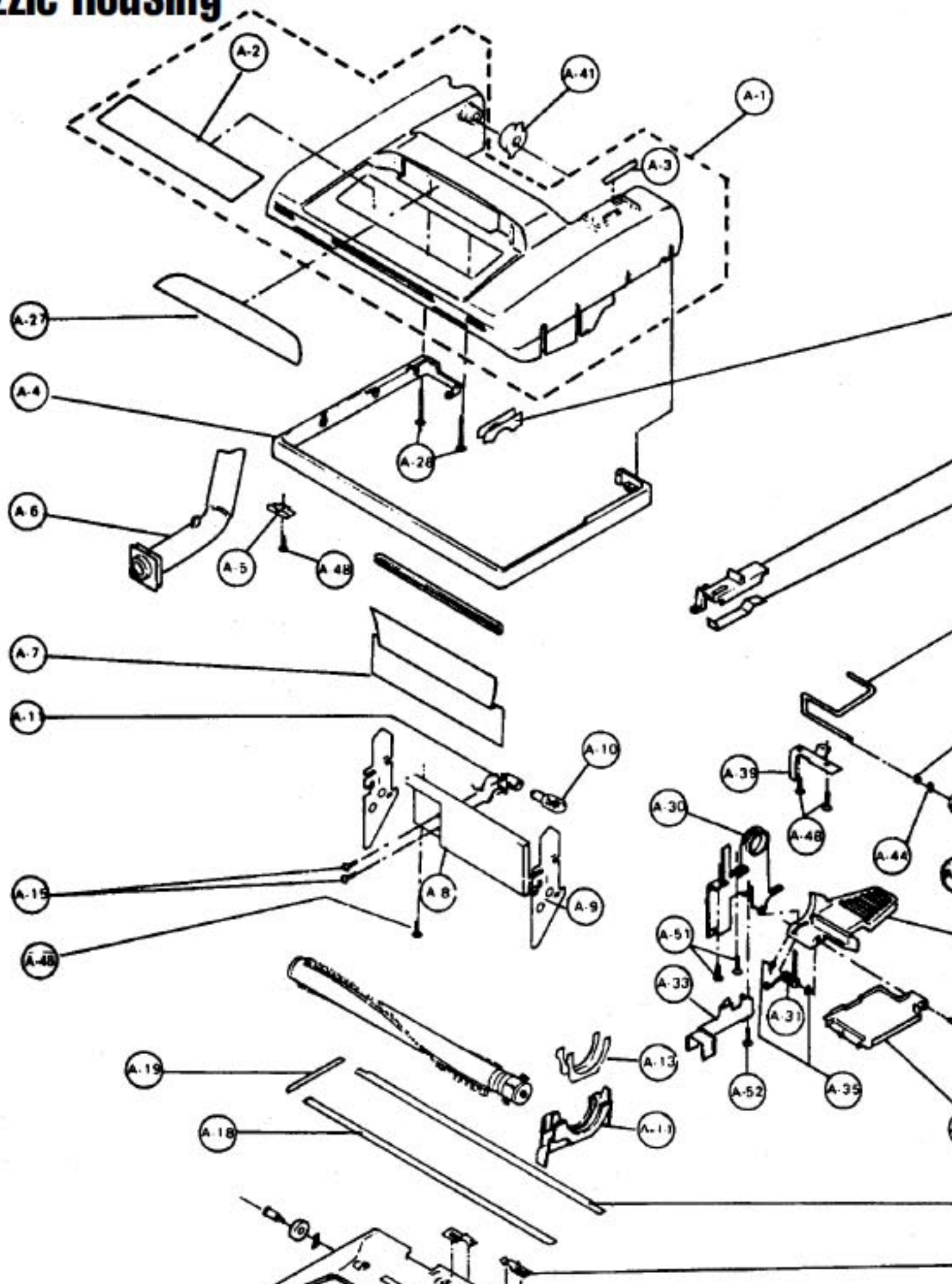

PANASONIC

Models: MC-6210, MC-6215, MC-6220, MC-6225, MC-6230

A1..... P-013	Nozzle Housing, 6210	A14..... P-4330	Belt Cover	A35..... P-05
A1..... N/A	Nozzle Housing, 6220	A15..... P-360	Screw	A36..... P-41
A1..... P-015	Nozzle Housing, 6230	A17..... P-2733	Lower Plate	A37..... P-18
A1..... P-0132	Nozzle Housing, 6215	A17..... P-0006	Lower Plate, metal	A37..... P-18
A1..... P-0133	Nozzle Housing, 6225	A18..... P-193	Packing, lower plate, front	A38..... P-24
A2..... P-2302	Top Mark, 6210	A19..... P-393	Packing, lower plate, right	A39..... P-59
A2..... N/A	Top Mark, 6220	A20..... P-7430	Packing, lower plate, back	A40..... P-85
A2..... N/A	Top Mark, 6230	A21..... P-503	Shaft, floor nozzle roller	A41..... P-25
A2..... P-0215	Top Mark, 6215	A22..... P-909	Roller, floor nozzle	A42..... P-33
A2..... P-0216	Top Mark, 6225	A23..... P-04	Spring Nut, push-on	A43..... P-85
A3..... N/A	Selector, mark	A24..... P-704	Spring, stop latch	A44..... P-05
A4..... P-1031	Furniture Guard, 6210,6220,6230	A25..... P-684	Latch	A45..... P-41
A4..... P-1037	Furniture Guard, 6215,6225	A26..... P-1032	Rubber, floor nozzle	A46..... P-32
A5..... P-2731	Hose Fitting Plate	A27..... P-2131	Window	A47..... P-24
A6..... P-7030	Nozzle Pipe	A28..... P-683	Screw	A47..... P-32
A7..... P-0010	Reflector	A29..... P-473	Pedal, 6210,6220,6230	A48..... P-41
A8..... P-853	Bulb Supporter	A29..... P-4730	Pedal, 6215,6225	A51..... P-20
A9..... P-863	Side Plate, bulb supporter	A30..... P-433	Frame	A52..... P-26
A10..... MP-25K	Bulb, (R)	A31..... P-583	Spring, pedal	A53..... P-24
A11..... N/A	Bulb Socket	A32..... P-513	Shaft, pedal	A54..... P-05
A12..... P-813	Tight Packing	A33..... P-754	Guide Lever	
A13..... P-753	Body Packing	A34..... P-1130	Belt Cover, rear	

Agitator Assembly

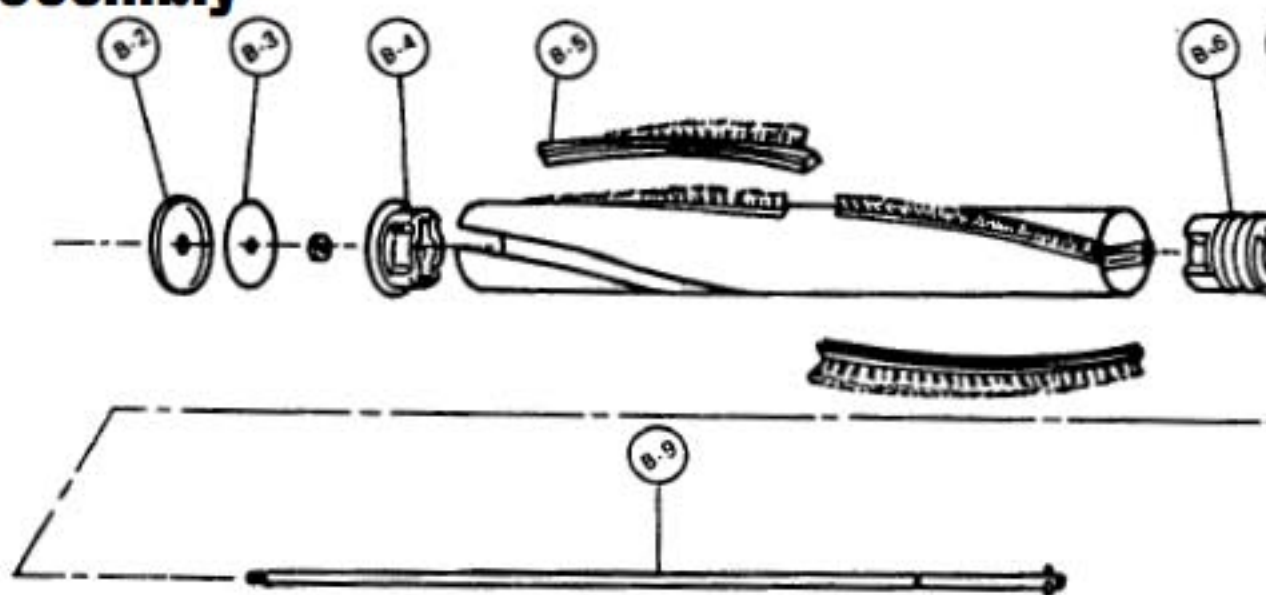

B1..... P-9231	Agitator Assembly, complete	B5..... P-85	Brush Strip	B9..... P-573
B1..... P-6200	Agitator Assembly, complete (R)	B5..... P-425	Brush Strip, (R)	P-411
B2..... N/A	End Cap, left	B6..... P-2931	Agitator Pulley, w/o bearing	B11..... P-743
B3..... P-321	Filter	B7..... P-9030	Brush Holder	P-350
B4..... P-4101	Agitator Holder, w/ bearing	B8..... P-00125	End Cap, right	

Motor Housing

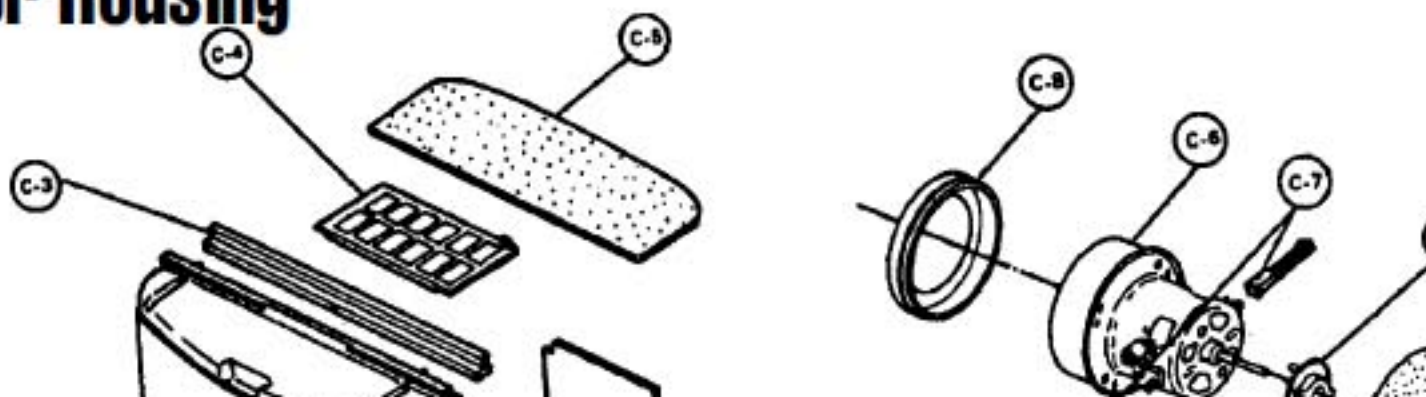

PANASONIC

Models: MC-6210, MC-6215, MC-6220, MC-6225, MC-6230

Body Assembly

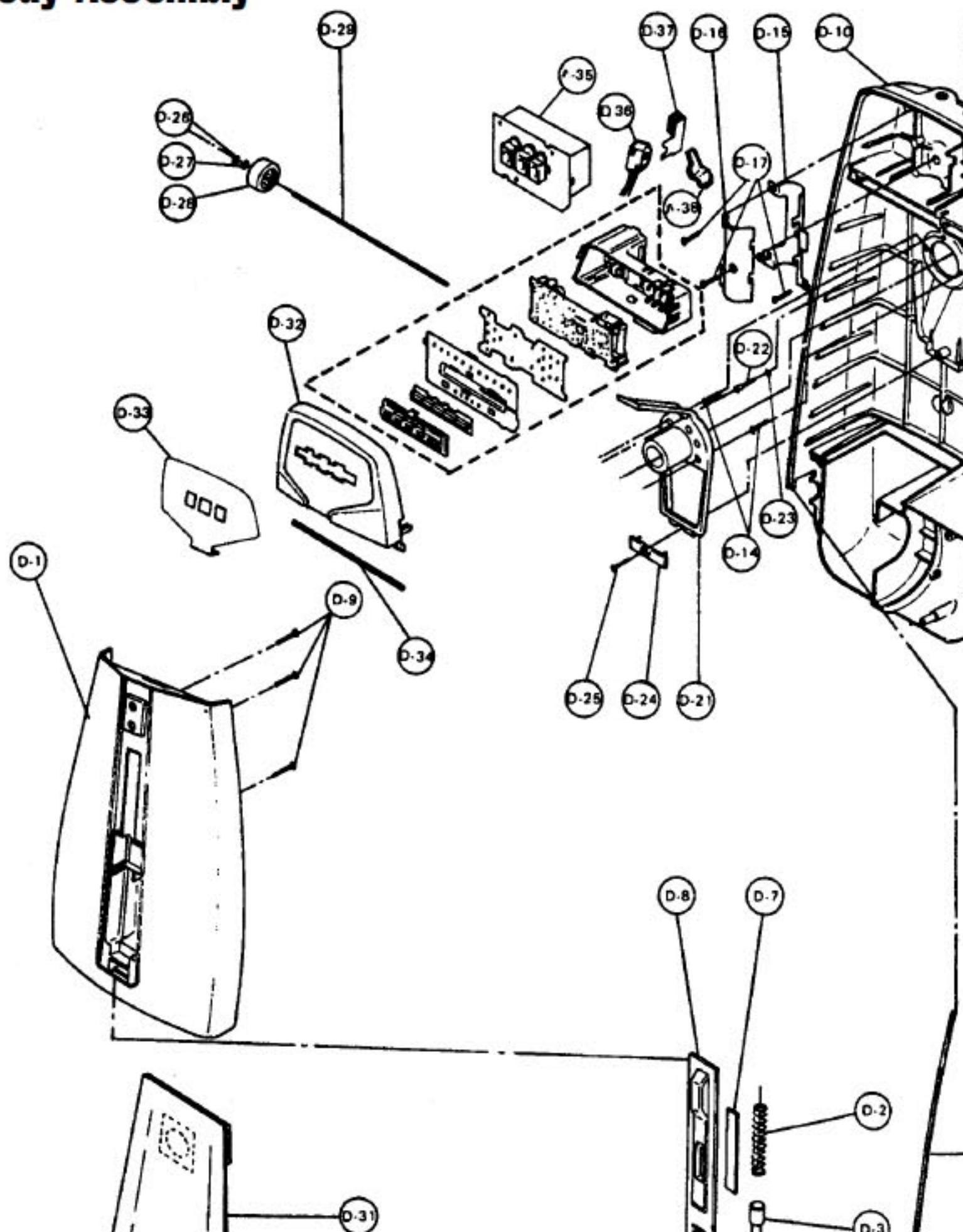

PANASONIC

Models: MC-6210, MC-6215, MC-6220, MC-6225, MC-6230

D1	P-604	Dust Cover, 6210,6220,6230	D14	P-416	Screw, 10 pk	D31	253
D1	P-6045	Dust Cover, 6215	D15	P-2485	Handle Supporter	D31	253-
D1	P-6032	Dust Cover, 6225	D16	P-2486	Handle Fitting	D31	P-99
D2	P-0430	Spring, indicator	D17	P-416	Screw, 10 pk	D31	P-55
D3	P-0049	Indicator Lead	D18	SS-34	Wire Bushing, sold each (R)	D32	P-03
D4	P-203	Supporter, indicator lead	D19	MP-230	Cord, 30 ft, white (R)	D32	P-03
D5	P-4340	Alarm Blade	D20	P-7330	Screw, handle	D33	N/A
D6	P-0630	Lever, alarm switch	D21	N/A	Bag Supporter	D33	P-21
D7	P-0830	Indicator Window	D22	P-2732	Screw	D33	P-21
D8	P-132	Front Cover, 6210,6220,6230	D23	P-0004	Washer	D33	P-21
D8	P-01401	Front Cover, 6215	D24	N/A	Spacer, bag supporter	D33	P-21
D8	P-01402	Front Cover, 6225	D25	P-416	Screw, 10 pk	D34	P-66
D9	P-416	Screw, 10 pk	D26	P-05	E-Clip, 30 pk		
D10	P-4030	Dust Compartment, 6210	D27	P-051	Washer	D34	P-73
D10	P-4040	Dust Compartment, 6220	D28	P-0107	Roller, 6210,6220,6230	D35	P-89
D10	P-4050	Dust Compartment, 6230	D28	P-0107	Roller, 6215,6225	D35	P-89
D10	P-4032	Dust Compartment, 6215	D29	P-163	Shaft, roller	D36	P-98
D10	P-4033	Dust Compartment, 6225	D30	P-7331	Packing, dust box, 6210, 6220,6230	D37	P-45
D11	P-647	Packing, suction inlet	D30	P-6631	Packing, dust box, 6215,6225	D38	P-15
D12	P-607	Suction Inlet, 6210,6220,6230	D31	P-115P	Paper Bag, 3 pack	D39	P-34
D12	P-6010	Suction Inlet, 6215,6225	D31	P-115PT	Paper Bag, 12 pack	D39	P-34
D13	N/A	Cover, 6210,6220,6230					

Power Indicator and Handle

