

This Owner's Manual is provided and hosted by Appliance Factory Parts.



PANASONIC V300 Owner's Manual

[Shop genuine replacement parts for PANASONIC V300](#)

Nozzle Housing

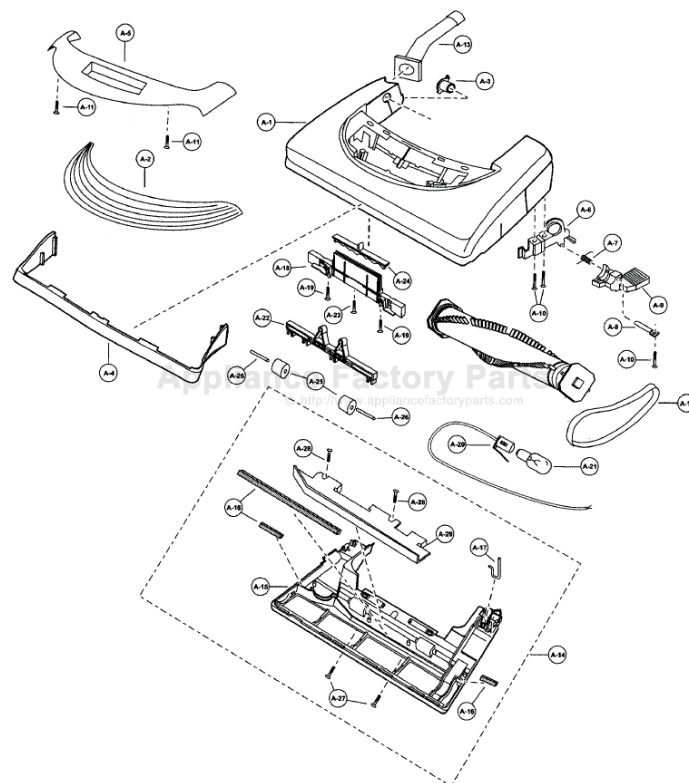

[Find Your PANASONIC Vacuum Cleaner Parts - Select From 605 Models](#)

----- Manual continues below -----

PANASONIC

Models: MC-V150, MC-V200, MC-V300, MC-V315

Nozzle Housing

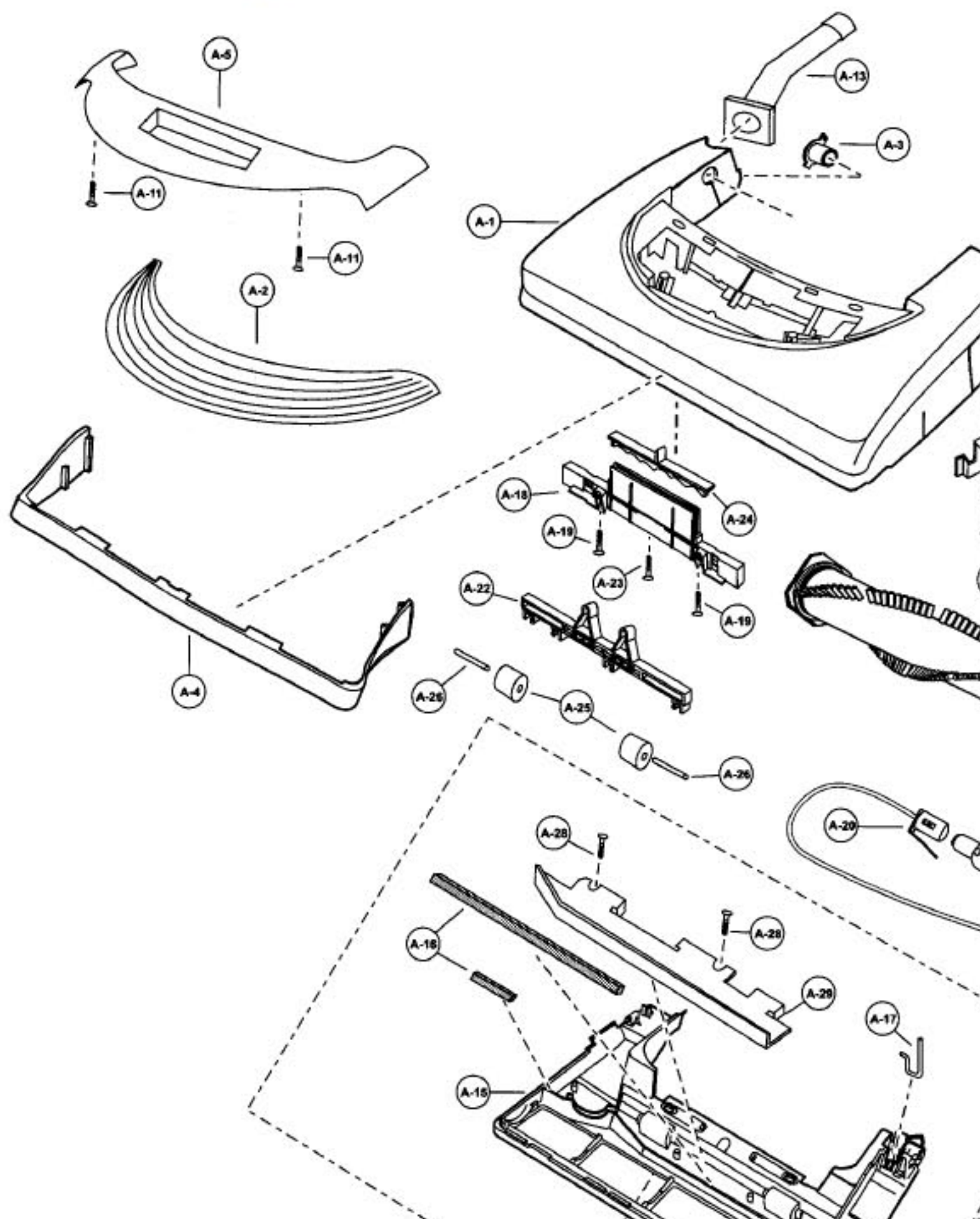

PANASONIC

Models: MC-V150, MC-V200, MC-V300, MC-V315

1..... P-10453..... Nozzle Housing, V150	12..... P-V270B..... Belt, 2pk	20..... P-936.....
1..... P-10523..... Nozzle Housing, V200	13..... P-10304..... Nozzle Hose, V150	21..... P-755.....
1..... P-10539..... Nozzle Housing, V300	13..... P-10108..... Nozzle Pipe, V300,V315	22..... P-105.....
1..... P-10817..... Nozzle Housing, V315	14..... P-10454..... Lower Plate Assy, V150	23..... P-680.....
2..... P-10540..... Window, V300	14..... P-10524..... Lower Plate Assy, V200	24..... P-105.....
2..... P-10818..... Window, V315	14..... P-10543..... Lower Plate Assy, V300	25..... P-988.....
..... P-10456..... Window Cover, V150	14..... P-10821..... Lower Plate Assy, V315	26..... P-988.....
..... P-10526..... Window Cover, V200	15..... P-10455..... Lower Plate, V150	26..... P-103.....
3..... P-2500..... Shaft, plastic	15..... P-10525..... Lower Plate, V200	27..... P-680.....
3..... P-10819..... Shaft, plastic, V315	15..... P-10544..... Lower Plate, V300	28..... P-614.....
4..... P-10541..... Furniture Guard, V300	15..... P-10822..... Lower Plate, V315	29..... P-976.....
4..... P-10820..... Furniture Guard, V315	16..... P-9860..... Packing, lower plate P-78.....
5..... P-10542..... Light Cover, V300,V315	16..... P-10394..... Packing, lower plate, V150,V315 P-984.....
6..... P-9878..... Frame, handle release, V300/15	17..... P-43..... Belt Guard, V150,V200 P-105.....
7..... P-58..... Spring, pedal	17..... P-9861..... Belt Guard, V300,V315 P-244.....
7..... P-9857..... Spring, pedal, V300,V315	18..... P-9863..... Slider Support	
8..... P-513..... Shaft, pedal	18..... P-10353..... Slider Support, V150	
9..... P-4720..... Pedal, handle release	18..... P-111217..... Slider Support, V200	
10..... P-02181..... Screw, frame	18..... P-10832..... Slider Support, V315	
11..... P-6140..... Screw, window cover	19..... P-6140..... Screw, slider support	

Agitator Assembly

- 1..... P-10439..... Agitator Unit
- 1..... P-10809..... Agitator Unit, V315
- 2..... P-0030..... Washer
- 3..... P-9906..... End Cap

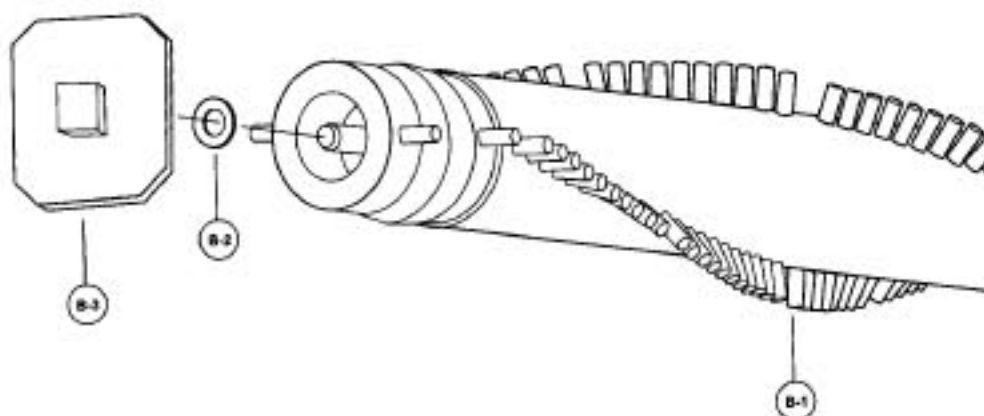

Handle, Hose & Attach-

MODEL MC-V300, MC-V315 ONLY

- 1..... P-9509..... Handle Assembly
- 2..... P-000633..... Cord Hook
- 3..... P-6800..... Screw, cord hook
- 4..... P-10560..... Handle
- 5..... P-8972..... Suction Inlet Cover
- 6..... P-10561..... Hose Unit, stretch
- 7..... P-9894..... Packing, suction inlet
- 8..... P-6069..... Crevice Tool
- 9..... P-8931..... Wand, telescoping
- 10..... P-10562..... Suction Control
- 11..... P-6088..... Dusting Brush
- 12..... P-6620..... Upholstery Nozzle

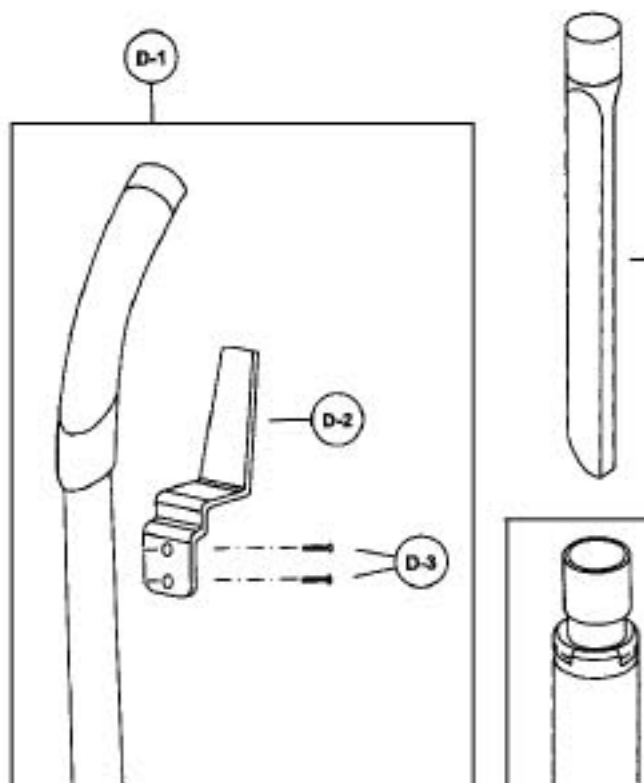

PANASONIC

Models: MC-V150, MC-V200, MC-V300, MC-V315

Body, Motor Housing & Motor

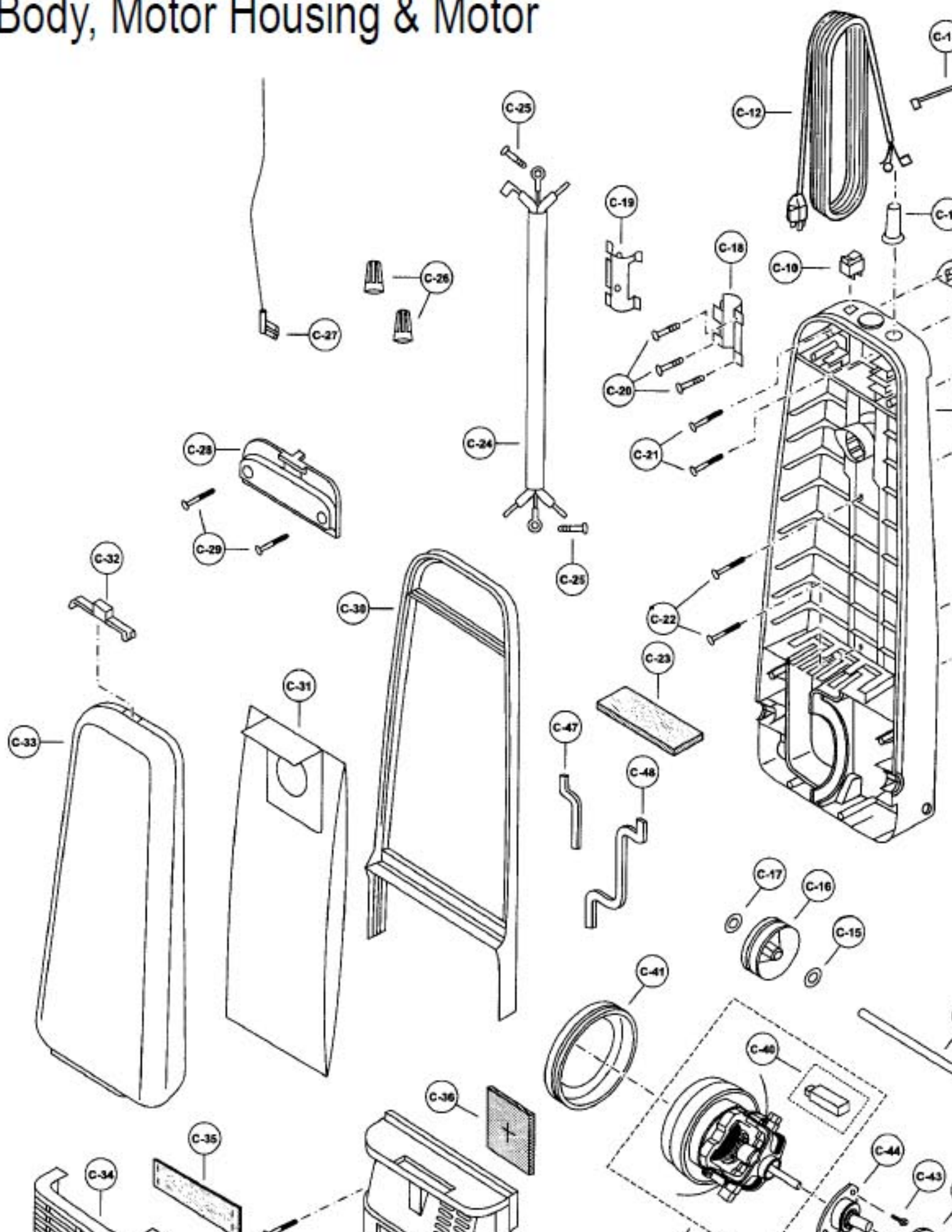

PANASONIC

Models: MC-V150, MC-V200, MC-V300, MC-V315

1.....	P-10457.....	Dust Compartment, V150	38.....	P-6140.....	Screw, motor c
1.....	P-10529.....	Dust Compartment, V200	39.....	P-10533.....	Motor Assy
1.....	P-10563.....	Dust Compartment, V300,V315	39.....	P-000629.....	Motor Assy, V
2.....	P-7330.....	Screw, handle	40.....	P-10393.....	Carbon Brush
3.....	P-10545.....	Carry Handle	41.....	P-0293.....	Motor Support
4.....	P-10546.....	Support Plate	42.....	P-10338.....	Motor Support
5.....	P-10547.....	Tool Holder	42.....	P-9911.....	Motor Support
6.....	P-6806.....	Protector Case	43.....	P-9912.....	Screw, motor f
7.....	P-692.....	Spring, protector, blue	44.....	N/A.....	Motor Flange
7.....	P-10388.....	Spring, protector, yellow, V150	45.....	P-93033.....	Motor Cover
8.....	P-000057.....	Protector	46.....	P-9931.....	Noise Suppres
9.....	P-1806.....	Protector Supporter	46.....	P-99300.....	Noise Suppres
10.....	P-8913.....	Switch, on/off, V150	47.....	P-5860.....	Body Packing,
10.....	P-10530.....	Switch, on/off, V200	48.....	P-3990.....	Body Packing,
10.....	P-10548.....	Switch, on/off, V300	49.....	P-000623.....	Wire Connecto
10.....	P-10602.....	Switch, on/off, V315	49.....	P-10450.....	Wire Connecto
11.....	P-10389.....	Rubber Protector		N/A.....	Suction Inlet, V
12.....	P-10380.....	Power Cord, 35 ft, V150		P-8972.....	Cover, suction
12.....	P-10531.....	Power Cord, 50 ft, V200		P-8915.....	Cover, suction
12.....	P-10429.....	Power Cord, 50 ft, V300		P-6140.....	Screw, suction
12.....	P-10823.....	Power Cord, 50 ft, V315		P-0036.....	Brush Retaine
13.....	P-00104.....	Wire Tie, 10pk		P-8946.....	Hose, V150
14.....	P-16005.....	Shaft Wheel		P-8917.....	Hose, V200
15.....	P-6115.....	Washer, wheel		P-10391.....	Cord Retainer,
16.....	P-10441.....	Wheel		P-10535.....	Cord Retainer,
17.....	P-74009.....	Stopper, wheel		P-10459.....	Cover Cap, V1
18.....	P-2486.....	Fitting, handle		P-10536.....	Cover Cap, V2
19.....	P-10549.....	Supporter, handle		P-10460.....	Handle Assy, V
20.....	P-8172.....	Screw, handle supporter		P-10537.....	Handle Assy, V
21.....	P-6140.....	Screw, carry handle		P-10461.....	Handle, V150
22.....	P-6140.....	Screw, tool holder		P-000631.....	Handle, V200
23.....	P-9829.....	Filter, secondary electrostatic		P-000633.....	Cord Hook, V1
23.....	P-10550.....	Filter, secondary electrostatic, V300		P-6800.....	Screw, cord ho
23.....	N/A.....	Filter, secondary electrostatic,, V315		P-10392.....	Caution Label,
	P-3200.....	Filter Supporter, V150,V200		P-6069.....	Crevice Tool, V
24.....	P-10385.....	Wire Cord		P-6088.....	Dusting Brush
24.....	P-10551.....	Wire Cord, V300,V315		P-8180.....	Wand, with tab
25.....	P-9912.....	Screw, grounding		P-9837.....	Hose Holder, V
26.....	P-000623.....	Wire Connector, switch area		P-10464.....	Hose Hook, V
27.....	P-4410.....	Lead Wire, black		P-10463.....	Hose Adaptor,
28.....	P-30606.....	Switch Cover,V150,V200			
28.....	P-10552.....	Switch Cover,V300,V315			
	P-10443.....	Latch, V150,V200			
29.....	P-6140.....	Screw, switch cover			
30.....	P-10553.....	Bumper			
31.....	P-145M.....	Paper Bag, type U6, micro, 3pk			
32.....	P-10554.....	Release Button, dust cover			