

This Owner's Manual is provided and hosted by [Appliance Factory Parts](#).

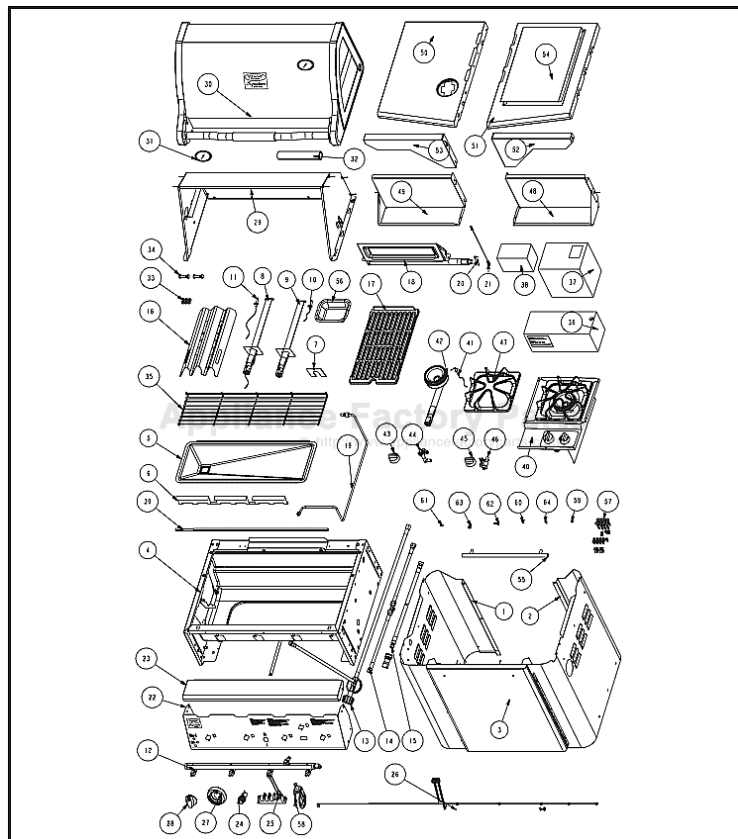

Vermont Castings VCS4027 Owner's Manual

[Shop genuine replacement parts for Vermont Castings](#)
[VCS4027](#)



[Find Your Vermont Castings Grill Parts - Select From 273 Models](#)

----- Manual continues below -----



VCS4007 / VCS4017 / VCS4027 / VCS4037
VCS5007 / VCS5017 / VCS5027 / VCS5037
ASSEMBLY PROCEDURES

Tools Required: knife or scissors, Phillips or Robertson (square head) screwdriver..

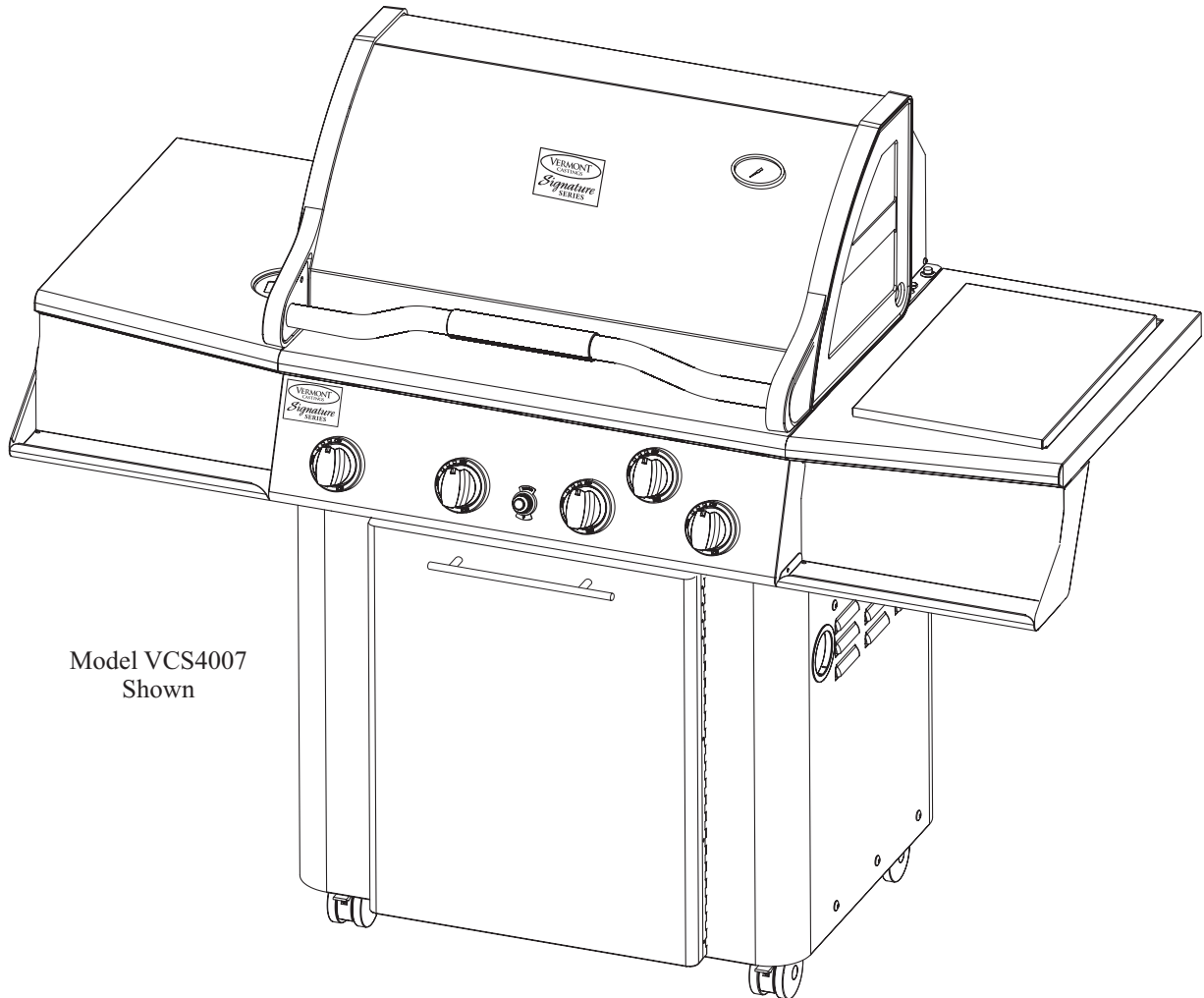

Model VCS4007
Shown

Step 1: Unpack Carton and Verify Contents

Use a sharp cutting tool to cut the straps on the packaging and then lift off the carton top. The sleeve surrounding the barbecue can be removed by lifting it straight up and over the top of the unit. Compare all contents to the parts list that accompanies this assembly manual. Next, remove the protective plastic coverings from the metal parts. Be careful not to scratch or damage the finish of the metal parts when removing the protective plastic. Refer to the parts list for fastener detail.

CAUTION: Some parts may have sharp edges; to avoid injury, wearing gloves during assembly is strongly recommended

Step 2: Install the Casters

Parts Required: (4) Casters, (1) Block (not included)

Note: Casters (wheels) may differ from those shown in the illustration depending on the model you purchased.

Select a side to begin installing the casters. Place a block of wood, a telephone book or anything else available - approximately 6 inches thick - under the side to support the weight of the barbecue. Next, insert the pin on the top of the caster into their respective holes located on the bottom, near the front and rear corners. If you have any difficulty snapping them into place, try rocking the castors in a circular motion. When both casters are in place, repeat the same procedure on the opposite side.

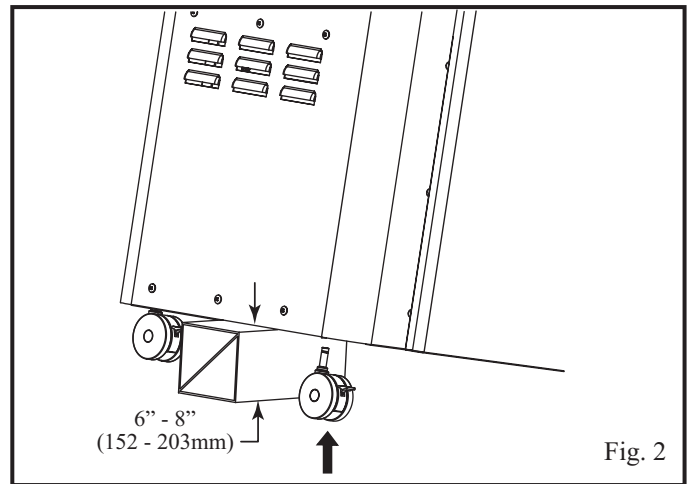

Fig. 2

Step 3: Install U-Clip Fasteners

Parts Required:

- (4) #10-20 U-Clip Fasteners
- (1) Left Side Shelf Support, (1) Left Side Shelf
- (1) Right Side Shelf Support, (1) Right Side Shelf

Install the one (1) U-Clip fastener to each of the Side Shelf Supports as shown in Fig. 3a. One (1) U-Clip should be placed on each bracket, with the flat side down.

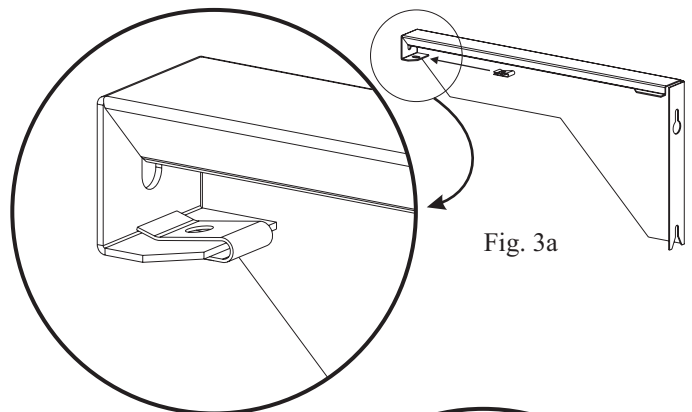

Fig. 3a

Install the one (1) U-Clip fastener to each of the Side Shelves as shown in Fig. 3b. One (1) U-Clip should be placed on the under side of each shelf, at the front outside corner, with the flat side out.

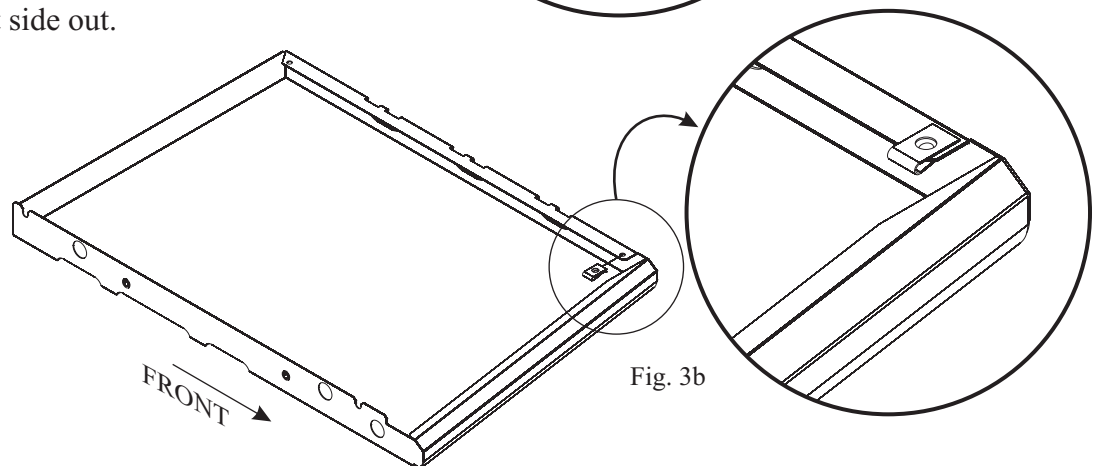

Fig. 3b

FRONT →

Step 4: Install the Side Shelf Supports

Parts Required:

- (1) Left Side Shelf Support
- (1) Left Condiment Tray
- (1) Right Side Shelf Support
- (1) Right Condiment Tray
- (8) 1/4-20 x 1-1/2" Bolts

Note: Only the right side assembly is shown in Fig. 4a and Fig. 4b. To install Left Side Support and Condiment Tray, repeat this step for the left side.

On the right side of the barbecue there are four threaded inserts, screw a bolt half way into each of the four threaded inserts. You will notice the bottom slot of the support has a 'Y' shaped slot and a 'keyhole' shaped hole above it. Take the Right Side Shelf Support and slide the top screw into the 'keyhole' and the bottom screw into the opening of the 'Y' shaped slot. Now take the Right Condiment Tray and align its holes over the two front bolts and gently push down until the bolts settle into the grooves of the tray.

Next: Gently push down on the support until the screw settles into the top of the groove. Do not fully tighten the support screws at this point.

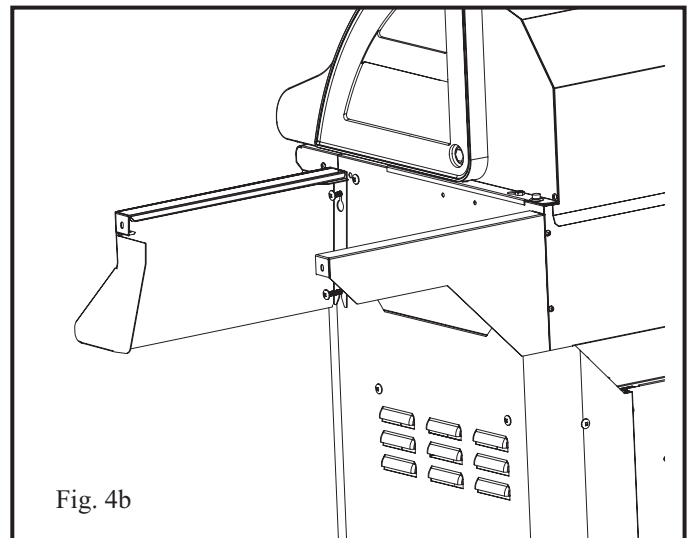
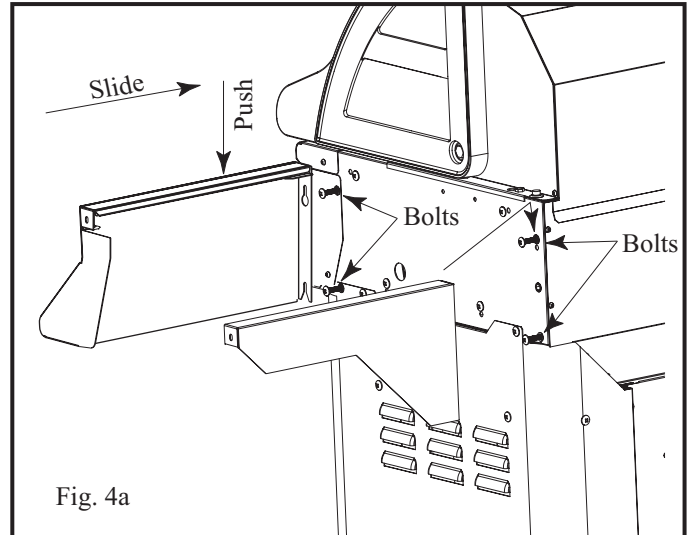

Step 5: Attach Shelves

Parts Required:

- (1) Right Shelf - S/B (Shown)
- (1) Left Shelf - Solid

Place the Right Shelf - S/B (shown) on top of the supports making sure the holes are aligned and then snap into place on the supports. The inside lip of the shelf will slide between the grill shell and the shelf supports.

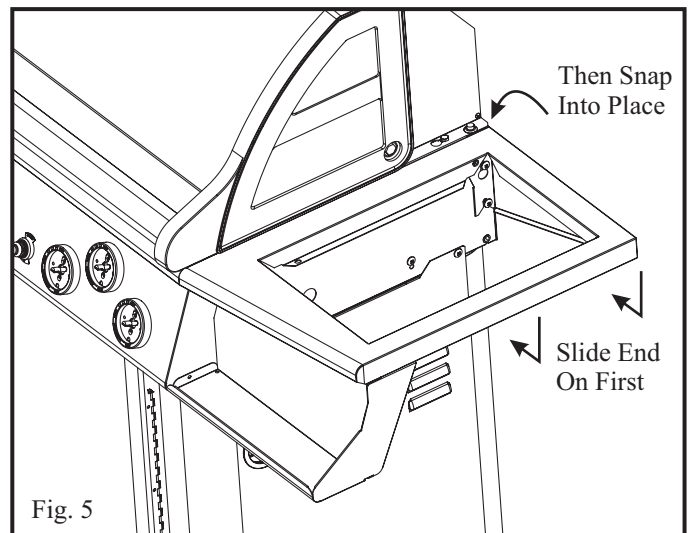

Step 6: Secure Shelves

Parts Required:

(4) 10-24 x 1/2" Bolts (black)

A. Secure each Shelf by inserting (2) 10-24 x 1/2" bolts through the U-Clip fasteners as shown in the diagram.

B. Tighten the four (4) Shelf Support bolts from Step 4 to secure the shelf supports to the grill body.

Repeat Steps 5 & 6 for the opposite side of the grill.

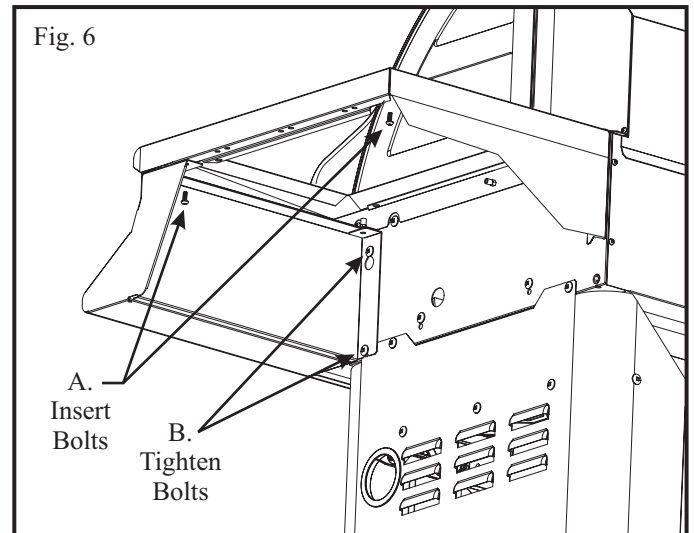

Step 7: Secure Side Shelf to Grill

Parts Required:

(3) 10-24 x 1/2" Bolts (black)

Lift the grill lid and insert two (2) #10-24 x 1/2" bolts, shown as "a" and "b" in Fig. 7, to further secure the Shelf Right - S/B to the grill body. Be sure to fully tighten the bolts before proceeding to the next step.

Next: Repeat Step 7 on the opposite side of the grill's interior to secure the Shelf Left - Solid to the grill body by inserting only one (1) #10-24 x 1/2" bolt in the "b" location as shown in the illustration.

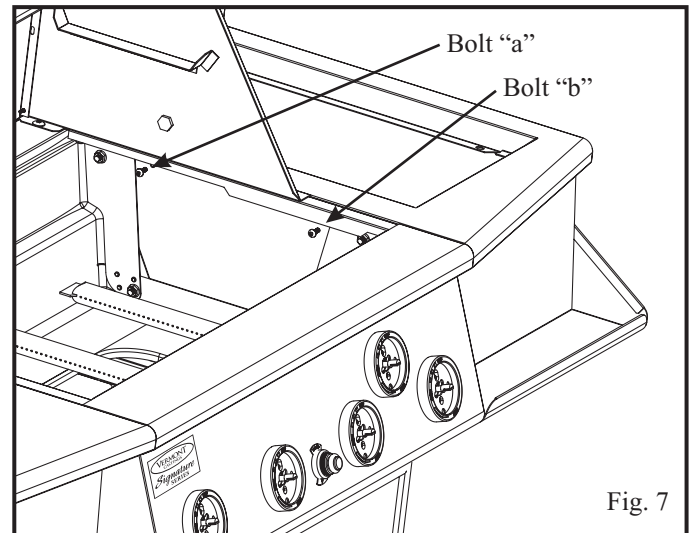

Step 8: Secure Condiment Tray to Console

Parts Required:

(2) #10-24 x 1/2" Bolts (stainless)

(2) #10-24 Nuts (black)

Secure the Left Condiment Tray to the Console using a #10-24 x 1/2" stainless bolt and a #10-24 nut. Make sure the holes of the Condiment Tray and the Console are aligned. Reach underneath the console and hold the nut in place with one finger and insert the bolt from the outside as shown in Fig. 8 and tighten until they are securely fastened.

Next: Repeat Step 5 to secure the Right Condiment Tray to the opposite side of the console.

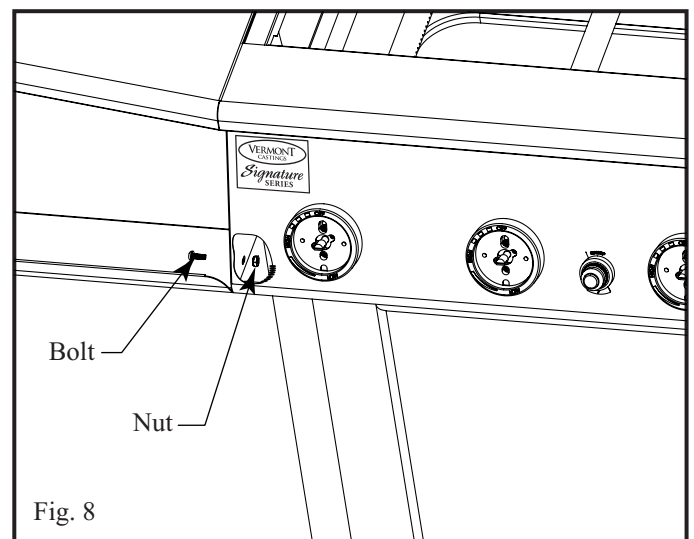

Step 9: Attach Side Burner Lid (S/B-Single)

Parts Required:

- (1) Side Burner Lid (S/B-Single)
- (2) #10-24 x 3/4" (1/4" Shank)*

* Included with the Side Burner Kit

Attach the lid marked (S/B-Single) to the Shelf Right top marked VM-S/B using two #10-24 x 3/4" (1/4" Shank) bolts. Align the holes at the back sides of the lid with the holes located in the shelf top and insert a bolt in each.

Note: If your unit is equipped with a side burner, please refer to the instruction sheet included with the side burner for installation instructions.

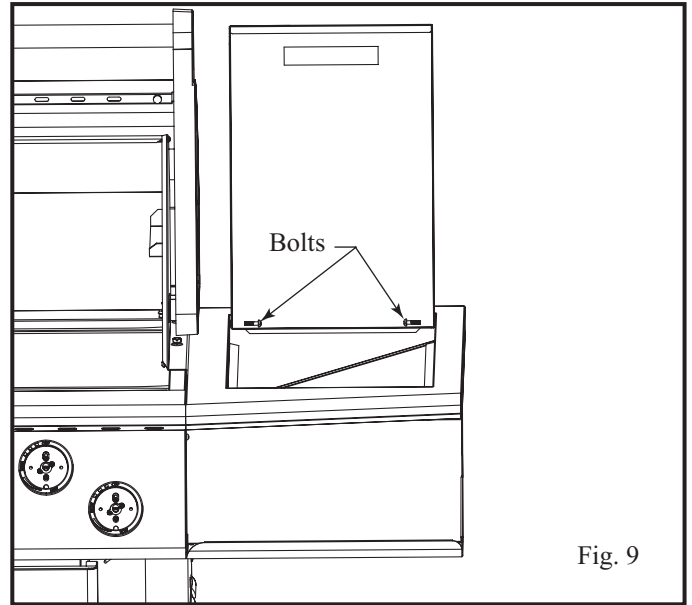

Fig. 9

Step 10: Attach Knobs

Parts Required:

- | | |
|--------------------|--------------------|
| VCS4007: (5) Knobs | VCS5007: (6) Knobs |
| VCS4017: (5) Knobs | VCS5017: (6) Knobs |
| VCS4027: (5) Knobs | VCS5027: (6) Knobs |
| VCS4037: (5) Knobs | VCS5037: (6) Knobs |

Note: Depending upon your specific model, your grill may require 5 or 6 knobs. Models VCS4007, VCS4017, VCS4027, & VCS4037 are equipped with five (5) knobs, and models VCS5007, VCS5017, VCS5027 & VCS5037 are equipped with six (6) knobs.

Align the knobs on the valve stems and push inward until the knob sits snugly on the stem.

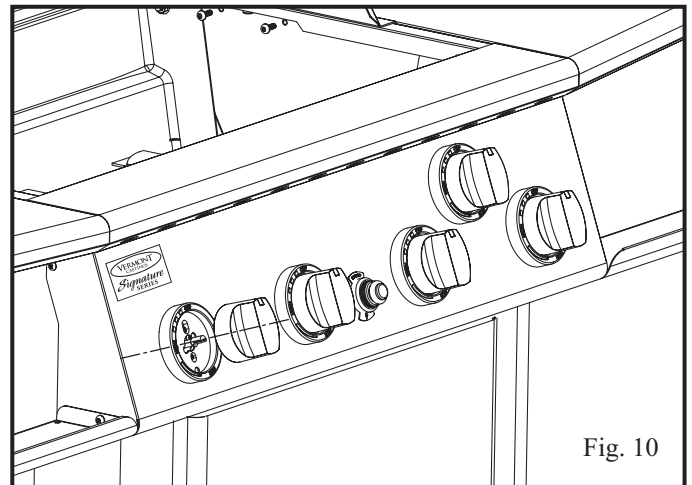

Fig. 10

Step 11: Remove the Packing Tape

Remove the Packing Tape from:

- The Grease Cup
- The Base Assembly (inside the grill)
- The Warming Rack

Note: For models VCS5007, VCS5017, VCS5027 & VCS5037, remove the Packing Tape from the front pull-out drawer.

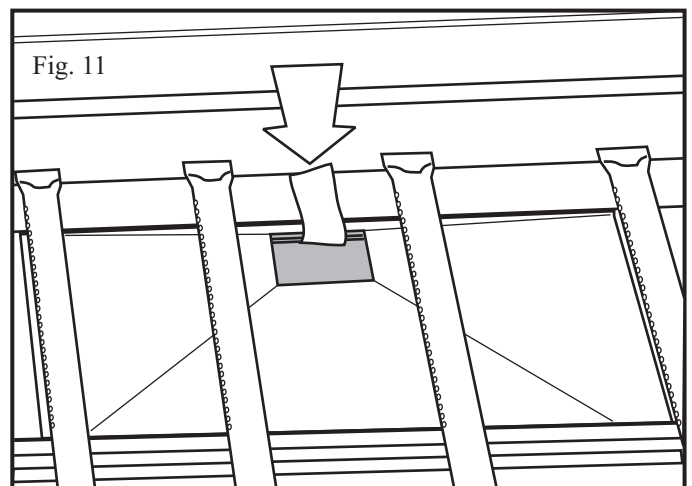

Fig. 11

Step 12: Attach the Handle to the Door

Parts Required:

- VCS4007/VCS4017/VCS4027/VCS4037: (1) Handle
- VCS5007/VCS5017/VCS5027/VCS5037: (3) Handles

Note: Handles may not appear exactly as shown in diagram

Attach the Door handle(s) to the door(s) by aligning the handles over the holes and inserting the screws that were supplied with the handles through the door panel and into the handles. For models VCS5007, VCS5017, VCS5027 & VCS5037, attach the drawer handle using the same method.

Note: If doors are not aligned or have shifted during shipping, they can be adjusted by loosening the screws which fasten the hinge of the door to the grill body and shifting the doors until they are aligned. Once satisfied with alignment, fully tighten the screws to secure the doors into position.

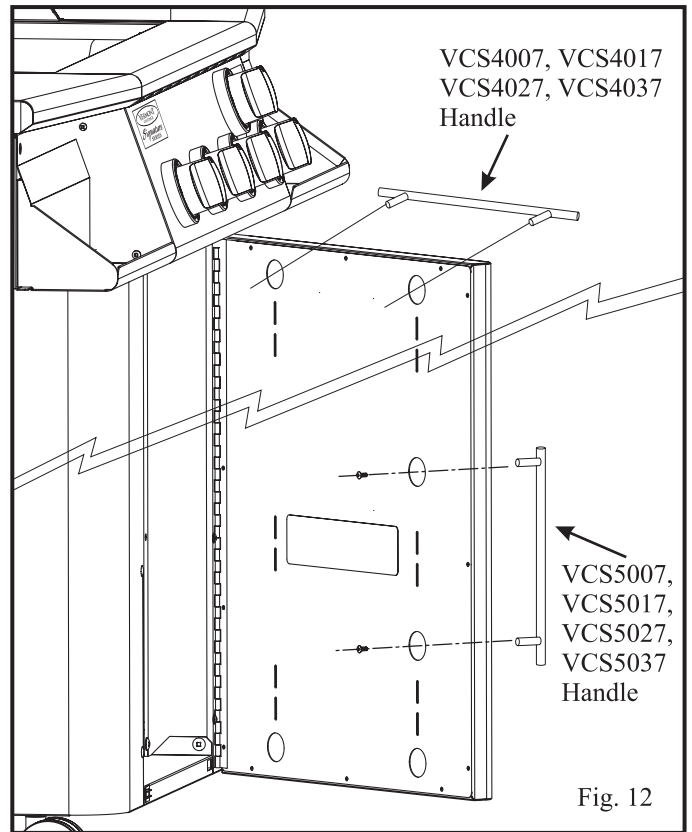

Step 13: Install the Grease Cup and Grease Pan

Parts Required:

- (1) Grease Cup
- (1) Grease Pan

Install the Grease Cup into the cut-out in the Upper Base Panel located underneath the grill. It is accessible from the back of the grill. Once the Grease cup is in place, move the Grease pan into position above it by placing the side edges onto the support rails and sliding it into place.

Note: Make sure the funnel opening of the grease pan is positioned over the Grease Cup.

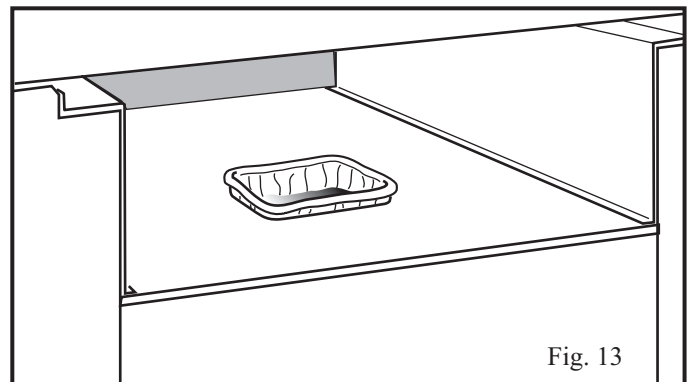

Step 14: Attach Stabilizer Bracket

Parts Required:

- (2) #10-24 x 1/2" Bolts (black)
- (1) Stabilizer Bracket

Attach the Stabilizer Bracket underneath the bottom panel by aligning the holes and inserting both #10-24 x 1/2" bolts through the panel and into the Stabilizer Bracket as shown in Fig. 14.

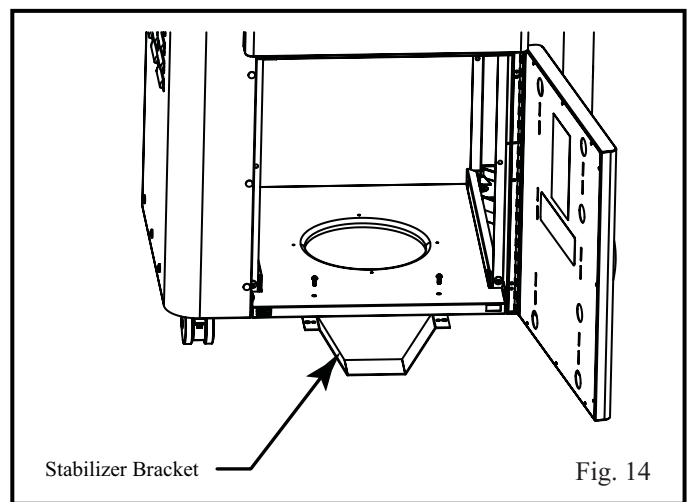

Step 15: Install the Internal Components

Parts Required:

VCS4007 / VCS4017 : (4) Sear Plates
VCS4027 / VCS4037 (3) Cooking Grates
(1) Warming Rack

VCS5007 / VCS5017 : (5) Sear Plates
VCS5027 / VCS5037 (4) Cooking Grates
(1) Warming Rack

Carefully place each of the Sear plates side by side inside the barbecue, making sure the semicircular finger groove is facing toward the front of the grill. Each sear plate rests just above each burner tube.

Next, set the cooking grates, side by side, on the upper ledge of the grill tub. Make sure the finger groove is facing toward the front of the grill.

Set the warming rack into the supports located on either side of the rear lid.

Note: One side of the Grate surface has a rounded side suitable for meats and a flat side suitable for delicate foods (i.e. fish). Grates can be turned over according to your preference.

Caution: Do not attempt to turn Cooking Grate over while the Grill is in use and grates are hot. Doing so could result in severe burns and other injuries.

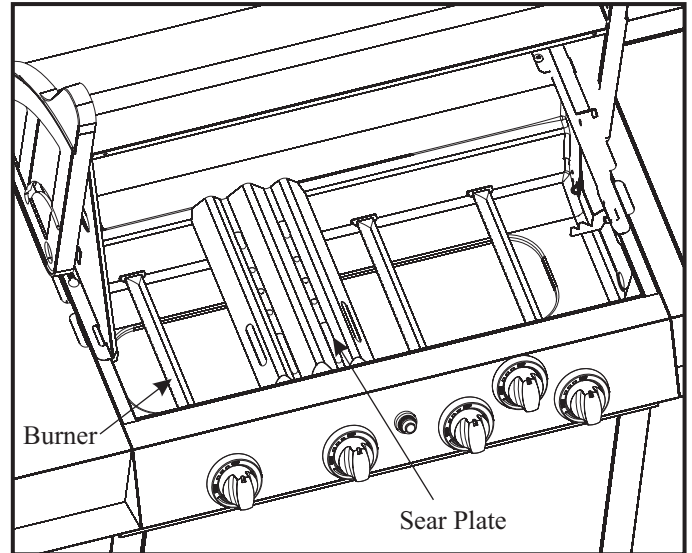

Fig. 15a

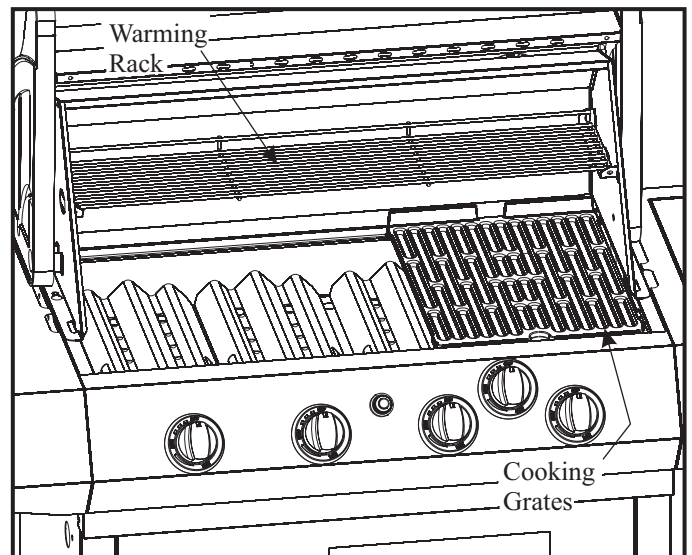
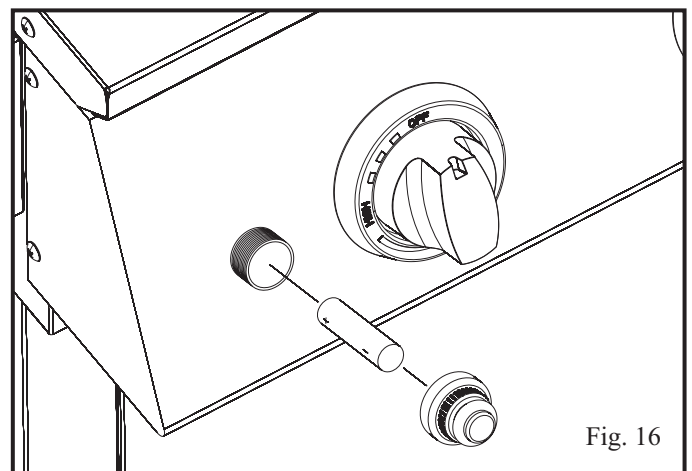

Fig. 15b

Step 16: Install the Battery

Note: requires a "AA" Battery.

Unscrew the Ignition Button from the console and insert a battery into the housing by placing the positive side of the battery in first. Then screw the Ignition button back into the console.



Step 17: Install the LP Cylinder (LP Models Only)

Parts Required:

(1) LP Gas Cylinder (not included)

Note: Check your user’s manual for the cylinder filling requirements, how to attach the regulator and how to test for leaks before you try lighting the grill.

Caution: Make sure the hose is not touching any hot surfaces.

Note: For Models VCS5007, VCS5017, VCS5027 & VCS5037, refer to Tank Pull-out assembly instructions included with the Tank Pull-out kit.

Place the LP Cylinder into the hole in the bottom panel. Next secure it from moving by lifting the Cylinder retainer wire and latching the bent edge over the lip of the Cylinder. The final step is to connect the Regulator to the Cylinder.

Caution: Do not turn on the grill until after performing a leak check at all connection points and fittings. Use a spray solution of 50% dish soap and 50% water onto all connection points and fittings. Formation of bubbles indicates air leaks.

Note: Ensure all plastic coatings have been removed from all stainless steel parts before using the grill.

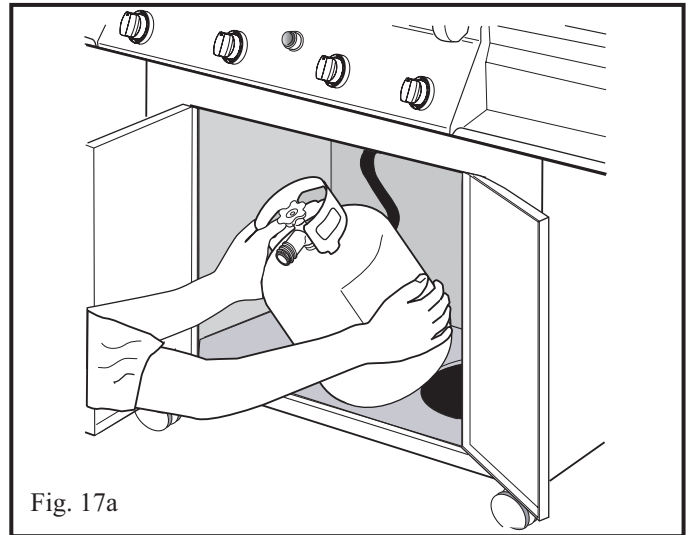

Fig. 17a

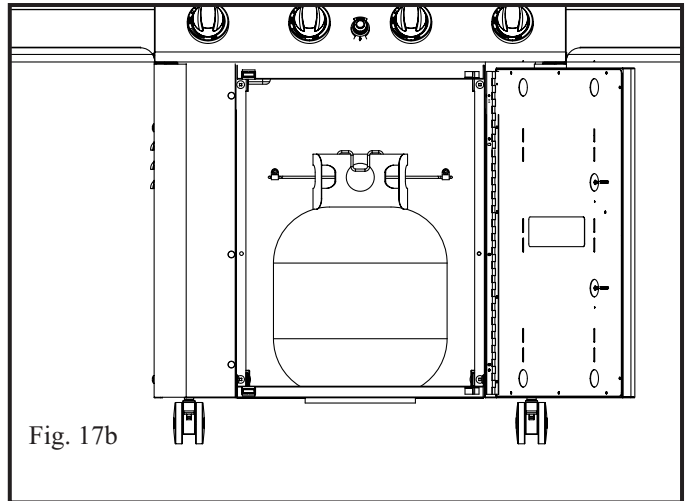

Fig. 17b



CFM Corporation
410 Admiral Boulevard
Mississauga, Ontario L5T 2N6 Canada
(800) 668-5323

www.cfmcorp.com

Service Note: If you are experiencing difficulties or are dissatisfied with your purchase, please contact CFM at the telephone number listed above prior to returning your grill to the store.