

Models: HV-800, HV-900

## "ARM" Floor Vac and Duster

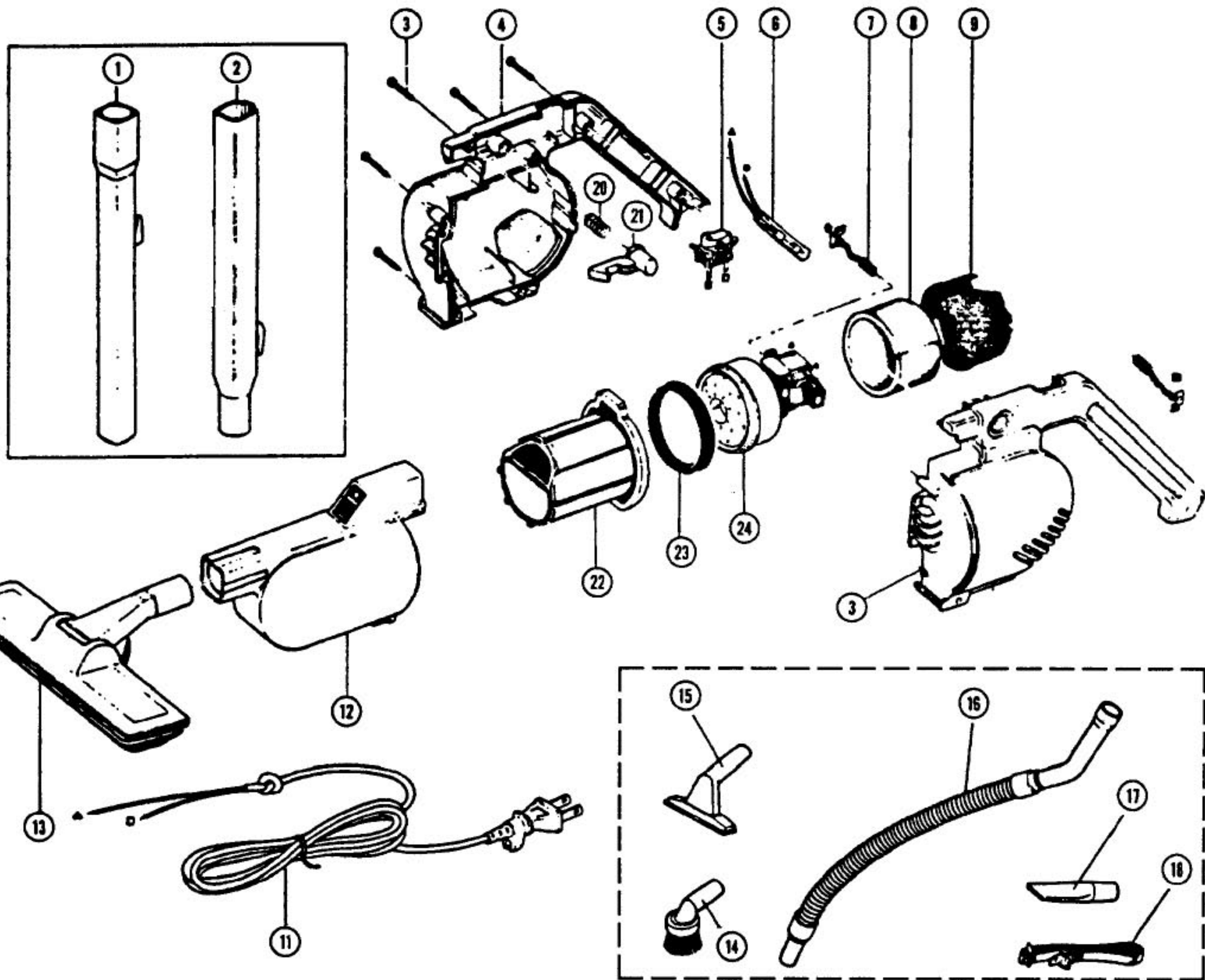

- |         |               |                               |          |               |                         |          |               |                          |
|---------|---------------|-------------------------------|----------|---------------|-------------------------|----------|---------------|--------------------------|
| 1 ..... | N/A .....     | Lower Wand, red               | 8 .....  | P-12554 ..... | Sound Insulation        | 16 ..... | P-12563 ..... | Hose                     |
| 1 ..... | P-12545 ..... | Lower Wand, white             | 9 .....  | P-12555 ..... | Sound Proof Rubber      | 17 ..... | P-12564 ..... | Crevice Tool, white      |
| 2 ..... | N/A .....     | Upper Wand, red               | 11 ..... | MP-225 .....  | Cord, white, 20 ft (R)  | 18 ..... | P-12565 ..... | Shoulder Strap           |
| 2 ..... | P-12547 ..... | Upper Wand, white             | 12 ..... | P-12556 ..... | Dust Compartment, red   | 20 ..... | P-12566 ..... | Spring, release button   |
| 3 ..... | N/A .....     | Screw                         | 12 ..... | P-12557 ..... | Dust Compartment, white | 21 ..... | P-12567 ..... | Release Button, red      |
| 4 ..... | P-12549 ..... | Main Body, both halves, red   | 13 ..... | P-12558 ..... | Floor Nozzle, red       | 21 ..... | P-12568 ..... | Release Button, white    |
| 4 ..... | P-12550 ..... | Main Body, both halves, white | 13 ..... | P-12559 ..... | Floor Nozzle, white     | 22 ..... | P-12569 ..... | Filter                   |
| 5 ..... | P-12551 ..... | Switch                        | 14 ..... | P-12560 ..... | Dusting Brush, red      | 23 ..... | P-12570 ..... | Gasket                   |
| 6 ..... | P-12552 ..... | Fuse                          | 14 ..... | P-12561 ..... | Dusting Brush, white    | 24 ..... | P-12571 ..... | Motor Assembly, complete |
| 7 ..... | P-272 .....   | Carbon Brush, set of 2        | 15 ..... | P-12562 ..... | Upholstery Brush, white |          |               |                          |