

This Owner's Manual is provided and hosted by [Appliance Factory Parts](#).



DE'LONGHI XA34BL Owner's Manual

[Shop genuine replacement parts for DE'LONGHI
XA34BL](#)



[Find Your DE'LONGHI Oven Parts - Select From 110 Models](#)

----- Manual continues below -----



GB

DIRECTIONS FOR USE TOASTER-OVEN-BROILER

De'Longhi products are the finest and most versatile available. Please read this booklet carefully to ensure you obtain the fullest benefit from your appliance.

F

MODE D'EMPLOI GRILL PAIN - FOUR - GRIL

Les produits De' Longhi sont les meilleurs et les plus polyvalents des électroménagers disponibles dans le commerce. Nous vous conseillons de bien vouloir lire attentivement ce mode d'emploi afin de tirer les meilleurs avantages de votre nouvel appareil.

E

INSTRUCCIONES PARA USO TOSTADOR - HORNO GRILL

Los productos De' Longhi son los mejores y los más versátiles del comercio. Les rogamos que lean atentamente este modo de empleo para poder utilizar lo mejor posible este electrodoméstico. Repase y guarde estas instrucciones.

P

INSTRUÇÕES PARA A UTILIZAÇÃO DA TORRADEIRA - FORNO - GRELHADOR

Os aparelhos da De'Longhi são os produtos mais requintados e versáteis que existem. Aconselhamos a leitura atenta das instruções para assegurar a melhor utilização deste aparelho.



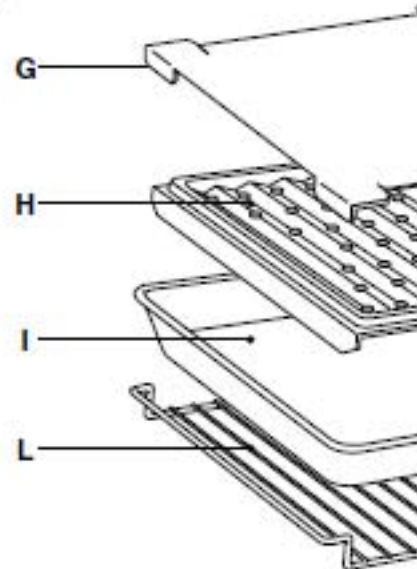
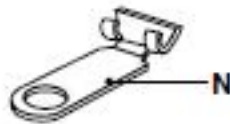
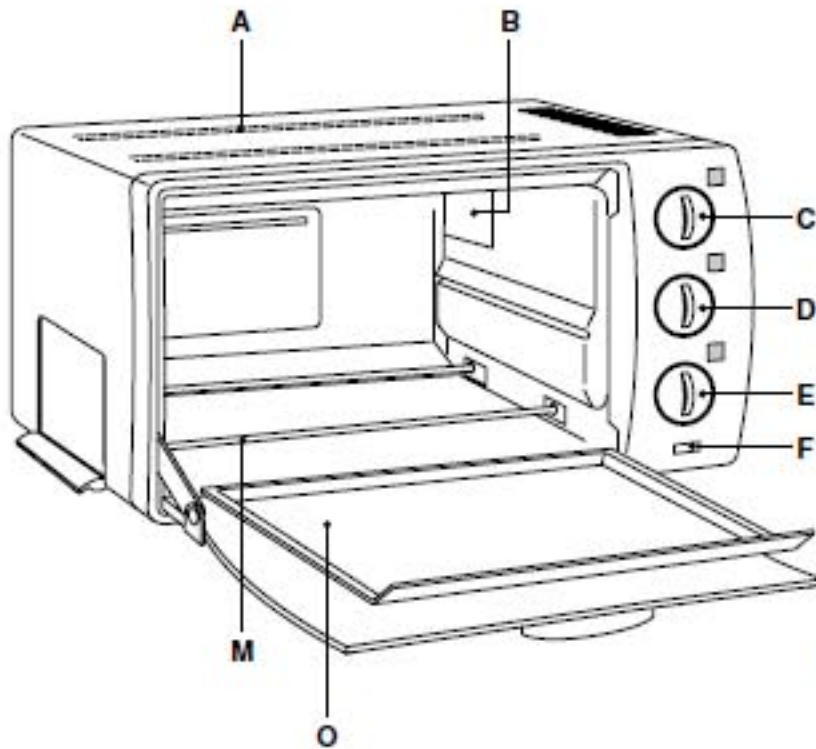

DESCRIPTION

A. Upper element	H. Broiling rack
B. Oven light (*)	I. Shallow pan
C. TEMP. dial	L. Wire rack
D. TIME dial (*)	M. Lower element
E. TOAST COLOR dial	N. Handgrip for wire rack (*)
F. power light	O. Crumb Tray (*)
G. Cookie sheet (*)	(*) <i>Optional: not for all models</i>

CONVERSION TABLE:

°C	°F
95	200
107	225
120	250



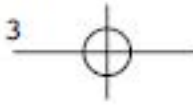

IMPORTANT SAFEGUARD

When using electric appliances basic safety precautions should always be followed, including

- 1) Read all instructions.
- 2) The temperature of the door or the outer surfaces may be high when the appliance is in use. Do not touch the plastic knobs and handles.
- 3) Before using this appliance, move it two to four inches away from the wall or any other surface. Remove any object that may have been placed on top of the appliance. Do not use the appliance if heat may cause a problem.
- 4) To protect against electrical shock, do not immerse cord, plugs, in water or other liquid. Do not use for cleaning.
- 5) The appliance is not intended for use by young children or infirm persons without supervision. Young children should be supervised to ensure that they do not play with the appliance.
- 6) Unplug from outlet when not in use and before cleaning. To disconnect the appliance from the wall outlet, turn the TOAST COLOR dials (E) to "OFF" and the TEMP. dial (C) to "●". Then unplug from the wall outlet. Allow to cool before putting on or taking off parts and before cleaning.
- 7) If the supply cord is damaged, it must be replaced by the manufacturer or its service agent or a qualified person in order to avoid a hazard.
- 8) The use of accessory attachments not recommended by the appliance manufacturer may create a fire hazard.
- 9) Do not use outdoors.
- 10) Do not place heavy objects on the open door. Do not forcefully push the open door closed. Do not place hot pans/baking tins (just removed from the oven) onto the open door.
- 11) Do not let cord hang over edge of table or counter, or touch hot surfaces.
- 12) Do not place on or near a hot gas or electric burner, or in a heated oven. Do not place the appliance in the oven while in use.
- 13) Extreme caution must be used when moving an appliance containing hot oil or other hot liquid.
- 14) If the plug gets hot, please call a qualified electrician.
- 15) Do not use this appliance for other than intended use.
- 16) Use extreme caution when removing the shallow pan (I) or disposing of hot grease.
- 17) Do not clean oven with metal scouring pads. Pieces can break off the pad and touch the oven elements, creating a risk of electric shock.
- 18) To assure safe operation, oversized utensils or food must not be inserted into the oven.
- 19) A fire may occur if this appliance is covered or touching flammable material, including curtains, walls, etc. when in operation.
- 20) CAUTION: Never leave the toaster-oven-broiler unattended when in use (except for toasting).
- 21) Extreme caution should be exercised when using containers other than ovenproof materials.
- 22) Do not store any materials other than the manufacturer's recommended accessories in the appliance when in use.
- 23) Do not place any of the following materials in the oven: paper, cardboard, plastic and other non-ovenproof materials.
- 24) Do not cover crumb tray or any part of the oven with metal foil; this can cause a fire. Use aluminum foil on or under food only as directed in the appliance instructions.
- 25) To avoid fire, do not use the appliance to toast bread, toast, or toast color.



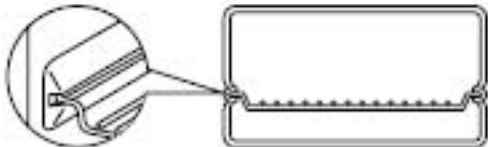
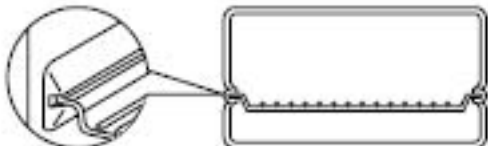
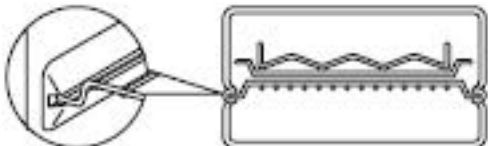
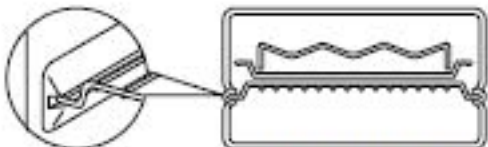
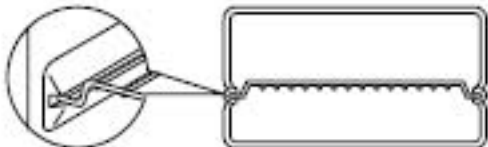
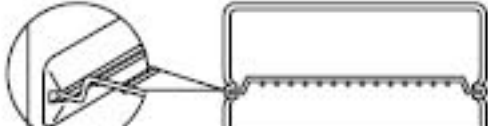

SUMMARY OF OPERATION

Program	Position of TOAST COLOR dial	Position of TEMP. dial	Position of TIME dial	Position of wire rack/accessories	
Keep warm	OFF	KEEP WARM	Up to 120 min.		Turn warm an h hot e dial u
Bake	OFF	UP TO 450 °F	Up to 120 min.		Ideal cass stuff othe requ and c
Broil	OFF	BROIL	Up to 120 min.	 <p style="text-align: center;">Lower position</p>  <p style="text-align: center;">Upper position</p>	Always the s The o show Use t faster requi side v the p and t Ideal steak Use t that n as ch For t rack side v
Top browning	OFF	BROIL	Up to 120 min.		Use t face s d'oue keep opera thus a
Toast	range of LIGHT to DARK	TOAST	OFF		Set the c



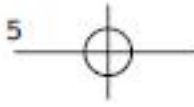

- Your product is equipped with a polarized alternating current line plug (a plug has one flat blade that is longer than the other). This plug will fit into the power outlet only one way. This is a safety feature. If you are unable to insert the plug fully into the outlet, try reversing the plug. If the plug should not fit, call your electrician to replace your obsolete outlet. Do not defeat the safety purpose of the polarized plug.
- Plug the cord into a 120 volt AC outlet.
- The cord length of this product has been selected to reduce the possibility of tangling. If a longer cord is needed, use a longer cord. If more cord length is needed, an extension cord may be used. It should be rated for at least 15 amps., 120 volts, and have Underwriters Laboratories/CSA listing.
- A six feet long, 15 amp. extension cord may be purchased from your local authorized retailer. If you are using a longer cord, be sure not to let it drape over the working area or dangle where it could be accidentally pulled or tripped over.
- Handle the cord carefully for longer life; avoid jerking or straining the cord at the connections.

- **Note:**

Initial start up operation may result in minimal smell and smoke (about 15 min.). This is due to the protective substance on heating elements which protects them from salt effects during storage.

OPTIONAL ACCESSORIES (not for all models)

- **COOKIE SHEET (G)**

Must be placed directly on the wire rack. Indispensable for baking biscuits and pastries.

- **OVEN LIGHT (B) AND POWER LIGHT (F)**

- If the oven light (B) has been provided for, said light will remain turned ON during the selected baking temperature. The power lamp (F) will turn OFF once the selected baking temperature is reached and will turn on and off during cooking.
- If your oven is not provided with the oven light (B), the power lamp (F) will light when the oven is switched on (it will not have the function of a temperature indicator).

- **HANDGRIP FOR WIRE RACK (N)**



Use handgrip to bring the wire rack out of the oven when cooking is finished.

COOKING PROGRAMS

1. HOW TO KEEP FOOD WARM

Place the food to be kept warm on the wire rack

- Set the TEMP. dial (C) to the KEEP WARM position.
- Set the TIME dial (D) up to 120 minutes.

Press the TOAST COLOR dial (E)





1. Close the door
2. Set the TEMP. dial (C) to the desired position/ temperature
3. Turn the TIME dial to the desired position/time
4. Do not set the TOAST COLOR dial (E)
5. **When baking is finished turn the TEMP. dial to the "●" position and the "OFF" position.**

• **NOTE:**

We do not recommend the use of glass covers on casseroles. Glass cooking dishes should never be closer than one inch from the heating element.

- **During the bake and toast function, do not put the shallow pan (or any other accessory/container) directly on the lower heating element.**

• **HELPFUL BAKING HINTS**

To obtain best performance from this toaster-oven-broiler:

- Do not overfill the oven. Whenever possible, place foods in center of oven.
- Avoid opening the door too frequently to prevent heat loss.
- Foil may be used to cover the baking dish or pan. Be sure the ends of foil are tucked under the edge of the baking dish/pan.

• **TEMPERATURE AND TIME FOR TYPICAL FOODS (baking and roasting)**

The suggested temperature and times will vary depending on the temperature of the food, quantity and personal preference. Times given for meat and poultry are for refrigerator temperature. **minutes for preheating the oven.** In order to avoid overcooking when using for the first time, set a low temperature. As you use the oven, the best settings will become familiar.

Food	Temperature setting	Approximate time	Notes and tips. (Refer to table on page 4)
Whole chicken 2,5-3 lbs. (1-1,5 kg.) Unstuffed	400 °F	80-90 min. or until internal temperature of 175 °F in thigh and breast	Turning at half time is required. It is possible to broil above the broiling position) inside the oven to reduce spattering.
Pork loin or Rib Roast 2-3 lbs (1-1,5 kg.)	400 °F	80-90 min. or until internal temperature of 170 °F is reached	Roast as for pork loin
Beef Sirloin or Rib Roast 3 lbs (1,5 kg.)	400 °F	60-70 min. or until tender and brown	No turning
Meat loaf 2-2,5 lbs (1-1,5 kg.)	350 °F	50-60 min.	Use the oven pan. No turning is needed. 1,5-2 lbs (700 g) (beef). With egg, pepper and flavourings.
Baking potatoes			Cut the potatoes in



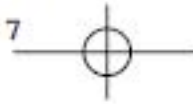

- **TOP BROWNING**

Top browning is ideal for melting, crisping and toasting food surfaces. Use it for open topped casseroles, buttered muffins or browning cooked casseroles.

1. Place the food on the oven pan and place it on the wire rack.
2. Close the door, set the TEMP. dial to BROIL.
3. Turn the TIME dial to the desired position/time.
4. Do not set the TOAST COLOR dial (E).

When experimenting with new uses, watch the food to avoid overbrowning.

When the browning cycle is completed (top surface with desired colour) turn the TEMP. dial to "OFF".

3. INSTRUCTIONS FOR BROILING

Always use the oven pan with the broiling rack for broiling. No preheating of the broiler is required.

Do not leave the broiler unattended when in use. Before using the broiler for the first time, wash the pan and the rack with warm, sudsy water. Do not cover the oven wire rack with foil.

This prevents fat and oils from draining, causing spatter and smoking, and also reduces smoke. Always use proper ventilation.

- **BROILING**

1. Place the oven wire rack as shown in the table on page 4.
2. Place the food to be broiled on the broiling rack (H) (set inside the oven pan), then place the oven pan on the wire rack.
3. **Always leave the oven door open to the stop position (as shown below).**
4. Turn the TEMP. dial to "BROIL".
5. Turn the TIME dial to desired position/time.
6. Do not set the TOAST COLOR dial.
7. When broiling is finished, turn the TIME dial to the "OFF" position and the thermostat dial to the "●" position. Care should be taken when turning food, removing the oven pan and disposing of the grease collected while broiling. Use hot pads.

- **Note:**

While smoke is an inherent characteristic of good broiling, the following tips should be followed to reduce smoking:

- Trim excess fat from meat and score the edges to prevent curling. Dry meat, fish and poultry with paper towel.
- For best results, thaw frozen meats before broiling. These two precautions will reduce smoke from the broiler.
- Placing the food on the broiling rack allows the juices and fat to drip into the oven pan, reducing spattering while broiling.
- If frozen steaks and chops are broiled, allow 1 and a half to 2 times the required broiling time required for unfrozen meat.
- If grease "pops" during broiling, turn the temperature control dial to a lower setting.
- Remove grease from the pan and wash the pan and broiling rack after use.



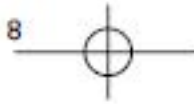

4. DIRECTIONS FOR AUTOMATIC TOASTING

- The capacity of the wire rack (L) is such as to allow the toasting of 6 slices of bread. In any case better results are obtained with 4 slices.
- For toasting, place the slices of bread as shown below:

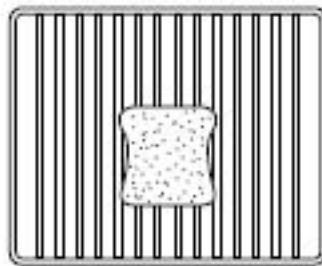

Toasting one slice

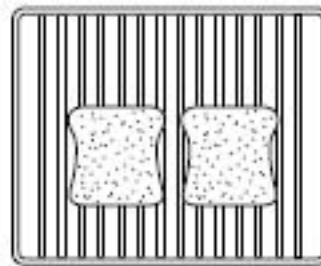

Toasting two slices

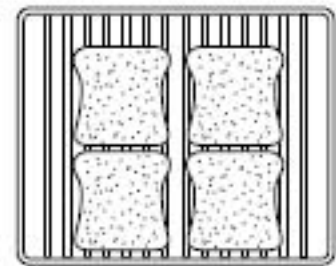

Toasting four slices

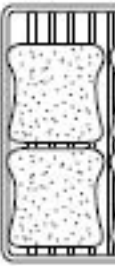

Toasting six slices

For consecutive toasting, turn the **TOAST COLOR** dial to a lower setting.

• INSTRUCTIONS FOR TOASTING

Always use the oven wire rack for toasting bread, sandwiches, English muffins, scones and waffles automatically.

1. Place the wire rack as shown in the table on page 4.
2. Center the food to be toasted on the wire rack. Close the door.
3. Set the **TEMP.** dial to "TOAST" position.
4. Do not set the **TIME** dial.
5. The **TOAST COLOR** dial (D) can be set clockwise for light, medium or dark toast or any setting in between.

When using the toaster-oven-broiler for the first time, set the dial (D) to a medium setting. Toast two pieces of bread to check for desired brownness. If necessary, adjust the control to a lighter or darker shade.
6. When toasting, both the top and bottom heating element switch on to brown both sides at the same time. Condensation may build up on the inside of the glass door. This is normal. The condensation will evaporate during the toasting cycle.
7. A ring indicates the end of the set time. The toasting cycle has been completed and the oven will shut off automatically. Turn the **TEMP.** dial to the "●" position.

• Note:

This toaster-oven-broiler is capable of toasting in a wide range of colours, automatically. However, if you prefer a lighter shade of toast, simply interrupt the automatic toasting cycle by turning the **TOAST COLOR** dial to "OFF". This will shut the unit off without damaging the oven. If you prefer a darker shade, restart the toasting cycle by turning the **TOAST COLOR** dial to the desired colour is obtained.

Then switch off manually the **TEMP.** dial and the **TOAST COLOR** dial as described. As you use the oven, the best settings for favourite breads will become familiar.

• HINTS FOR TOASTING SUCCESS

Heavier breads and frozen breads will require a darker setting. One slice of bread will require a darker setting than several slices.



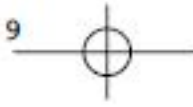

CLEANING AND MAINTENANCE

Always unplug the toaster-oven-broiler and allow it to cool before cleaning. It is designed and engineered with your safety in mind. To assure maximum safe operation, clean the interior regularly to prevent the accumulation of grease and build up of food particles.

1. Remove the wire oven rack.
2. To clean the inside walls, use a damp cloth and a mild liquid soap solution. Never use abrasive or corrosive products or spray detergents.

- **Note:**

Do not clean interior with metal scouring pads. Pieces can break off and create a fire hazard, creating risk of electrical shock.

3. To clean the glass door, use a glass cleaner or a damp cloth. Wipe dry with a clean cloth.
4. To clean the exterior finish, use a damp, sudsy cloth. For stubborn stains, a non-abrasive spray glass cleaner may be used. Do not use metal scouring pads, as they might scratch the finish. Remove cleaning agents by polishing with a dry cloth.
5. The wire rack, the oven pan and the broiling rack may be washed as other kitchen utensils.

- **CLEANING THE BOTTOM OF THE OVEN**

If your oven has a bottom that can be opened:

To clean the bottom of the oven, open the access panel by pressing the latch spring on the bottom of the access panel downwards. (see fig. A/B). Place the oven on its rear panel. This will make cleaning easier.

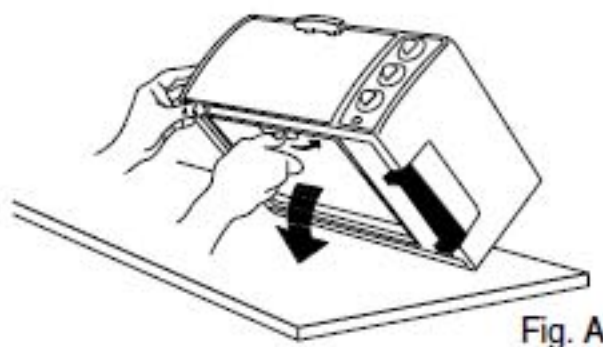

Fig. A



Fig. B

Clean the oven floor after use to avoid build-up of residue, as this will affect the cooking. Remove crumbs or wipe the oven floor with a damp cloth. For stubborn stains, use a nylon brush or a non-caustic cleaner, dry thoroughly before closing.

After cleaning, close the access panel and check that it is locked securely into position.

If your oven has a crumb tray:

Slide the crumb tray out from under the bottom of your oven (see Fig. C). Wash by hand. Should the soilage be difficult to remove, rinse the crumb tray with hot soapy water and if necessary, scour it delicately, without scratching it.

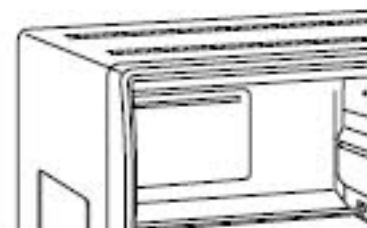



LIMITED WARRANTY

What does the warranty cover?

We warrant each appliance to be free from defects in material and workmanship. Our warranty is limited to repair at our factory or authorized service center of any defective part other than parts damaged in transit. In the event of a product's replacement or return, the unit and transportation prepaid. The repaired or new model will be returned at the company expense. This warranty shall apply only if the appliance is used in accordance with the factory directions, and on an Alternating current (AC) circuit.

How long does the coverage last?

This warranty runs for one year (1) from the purchase date found on your receipt and original purchaser for use.

What is not covered by the warranty?

The warranty does not cover defects or damage of the appliance, which result from repairs or alterations outside our factory or authorized service centers, nor shall it apply to any appliance, which has been misused, neglected or damaged by accidents. Also, consequential and incidental damage resulting from the breach of contract or breach of this warranty are not recoverable under this warranty. We do not allow the exclusion or limitation of incidental or consequential damage, so the above limitation may not apply to you.

How do you get service?

If repairs become necessary please contact our toll free hotline at **1-800-322-3848** or visit us at **www.delonghi.com**.

The above warranty is in lieu of all other express warranties and representations. All implied warranties are limited to the applicable warranty period set forth above. This limitation does not apply if you purchase your appliance with De'Longhi. Some states do not allow limitations on how long an implied warranty lasts, so the above limitation may not apply to you. De'Longhi does not authorize any other person to assume any liability in connection with the sale or use of its appliance.

How does state law apply?

This warranty gives you specific legal rights, and you may also have other rights, which vary by state.

