

This Owner's Manual is provided and hosted by [Appliance Factory Parts](#).

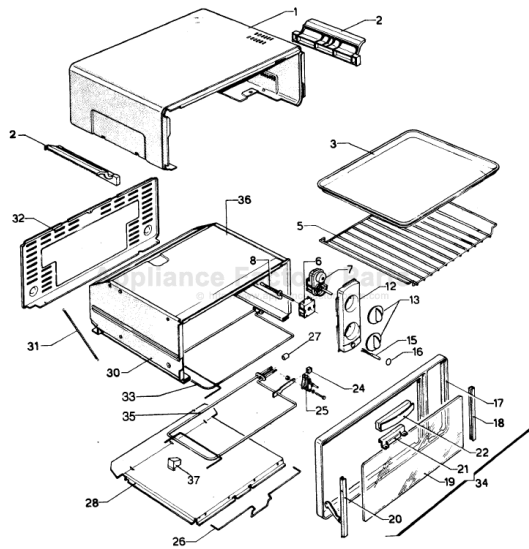

DE'LONGHI XU12 Owner's Manual

[Shop genuine replacement parts for DE'LONGHI XU12](#)



[Find Your DE'LONGHI Oven Parts - Select From 110 Models](#)

----- Manual continues below -----



DIRECTIONS FOR USE

TOASTER-OVEN-BROILER

De' Longhi products are the finest and most versatile products available. Please read this booklet carefully to ensure that you obtain the fullest benefit from your appliance.

MODE D'EMPLOI GRILLE-

PAIN - FOUR - GRILL

Les produits De' Longhi sont les meilleurs et les plus polyvalents électroménagers disponibles dans le commerce. Nous vous prions de bien vouloir lire attentivement ce mode d'emploi afin de tirer les meilleurs avantages de votre nouvel appareil.

INSTRUCCIONES PARA EL

USO TOSTADOR - HORNO -GRILL

Los productos De' Longhi son los mejores y los más versátiles del comercio. Les rogamos que lean atentamente este manual, para poder utilizar lo mejor posible este electrodoméstico.

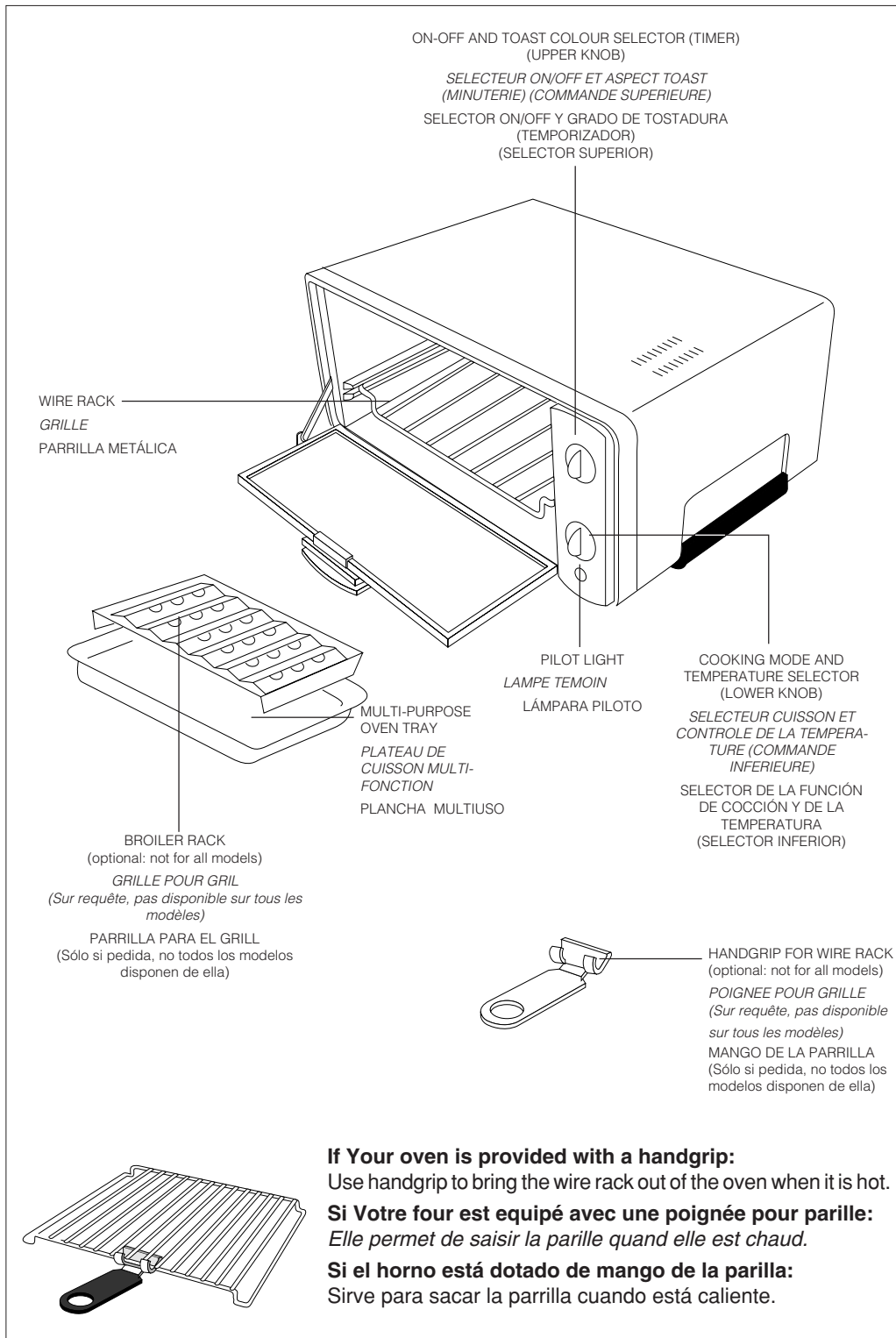

Summary of operations



Program	Position of ON/OFF and toast colour selector	Position of cooking mode and temperature selector	Position of wire rack/ oven tray
Keep warm	ON	KEEP WARM	1
Bake	ON	UP TO 450°F	2
Broil	ON	BROIL	3
			4
			If Your oven is provided with a BROILER RACK
			5
			LOWER POSITION with broiler rack inserted in the oven tray
			6
UPPER POSITION with broiler rack inserted in the oven tray			
Toast	Up to 7 minutes	TOAST	7
Sandwich	Up to 7 minutes	TOAST	8

CAUTION: Do not use the "Alfredo Pizza Stone" on this model. Such stone can be used on other De'Longhi bake'n broil toaster ovens. During the bake and toast function, do not put the multi-purpose oven tray (or any other accessory/container) directly on the lower heating element.

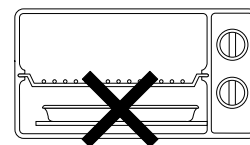

Bake or Toast

IMPORTANT SAFEGUARDS

When using electrical appliances, basic safety precautions should always be followed, including the following:

1. READ ALL INSTRUCTIONS.
2. Do not touch hot surfaces: Use handles or dials.
3. Before using this appliance, move it two to four inches away from the wall or any object on the counter top. Remove any object that may have been placed on top of the appliance. Do not use on surfaces where heat may cause a problem.
4. To protect against electrical shock, do not place unit in or under water. See instructions for cleaning.
5. Close supervision is necessary when any appliance is used by or near children.
6. Unplug from outlet when not in use and before cleaning. Always turn the unit OFF before unplugging. Allow to cool before putting on or taking off parts, and before cleaning the appliance.
7. Do not operate any appliance with a damaged cord or plug or after the appliance malfunctions, or has been damaged in any manner. Return appliance to the nearest authorized service facility for examination, repair or adjustment.
8. The use of accessory attachments not recommended by the appliance manufacturer may cause injuries.
9. Do not use outdoors.
10. Do not let cord hang over edge of table or counter, or touch hot surfaces.
11. Do not place on or near a hot gas or electric burner.
12. Extreme caution must be used when moving an appliance containing hot oil or other hot liquids.
13. If the plug gets hot, please call a qualified electrician.
14. Do not use this appliance for other than intended use.
15. Use extreme caution when removing the multi-purpose oven tray or disposing of hot grease.
16. Do not clean with metal scouring pads. Pieces can break off the pad and touch electrical parts, creating a risk of electric shock.
17. To assure safe operation, oversized foods or utensils must not be inserted into the oven.
18. A fire may occur if this appliance is covered or touching flammable material, including curtains, draperies, walls, etc., when in operation.
19. CAUTION: Never leave the toaster-oven-broiler unattended when in use, especially when broiling and toasting.
20. When broiling, the multi-purpose oven tray assembly and wire rack must be used according to the instruction on page 6.
21. Extreme caution should be exercised when using containers constructed of other than metal or glass.
22. Do not store any materials, other than the manufacturer's recommended accessories, in the oven when not in use.
23. Do not place any of the following materials in the oven: paper, cardboard, plastic and the like.
24. Do not cover any part of the oven with metal foil. This will cause overheating of the oven.
25. To switch off the toaster-oven-broiler, turn the ON/OFF knob to "OFF" and the cooking mode knob to "●".

THIS PRODUCT IS FOR HOUSEHOLD USE ONLY
SAVE THESE INSTRUCTIONS

- Your product is equipped with a polarized alternating current line plug (a plug having one blade wider than the other). This plug will fit into the power outlet only one way. This is a safety feature. If you are unable to insert the plug fully into the outlet, try reversing the plug. If the plug should still fail to fit, contact your electrician to replace your obsolete outlet. Do not defeat the safety purpose of the polarized plug.
- Plug the cord into a 120 volt AC outlet.
- The cord length of this product has been selected to reduce the possibility of tangling in or tripping over a longer cord. If more cord length is needed, an extension cord may be used. It should be rated no less than 15 amps., 120 volts, and have Underwriters Laboratories/CSA listing.
- A six feet long, 15 amp. extension cord may be purchased from your local authorized service facility. When using a longer cord, be sure not to let it drape over the working area or dangle where someone could accidentally pull or trip over it.
- Handle the cord carefully for longer life; avoid jerking or straining the cord at the plug and appliance connections.

NOTE: Initial start up operation may result in minimal smell and smoke (about 15 min.). This is normal. It is due to the protective substance on heating elements which protects them from salt effects during shipping from factory.

COOKING PROGRAMMES

The pilot lamp lights when the appliance is plugged into the mains. It does not mean that the oven has reached the selected temperature.

1) HOW TO KEEP FOOD WARM

Place the food to be kept warm on the wire rack (in position 1 - please see page 3). Turn the upper knob to "ON". Turn the lower knob to "KEEP WARM". This feature is designed to keep foods warm, after they are cooked for short periods of time without overcooking. We do not recommend keeping foods warm for prolonged periods or using this feature to reheat frozen or cold foods. Once the "keep warm" function is no longer needed, turn the lower knob to "●" and the upper knob to "OFF".

2) INSTRUCTIONS FOR BAKING

You can bake foods in your oven, just as in your regular oven. Casseroles or baking dishes may be placed directly on the removable wire rack. Use the convenient bake/broil tray provided with your oven for baking such items as cookies, biscuits, rolls and uncovered casserole dishes. Place the bake/broil tray directly on the removable wire rack (position 2 - please see page 3).

1. Close the door.
2. Set the lower knob to the desired position/temperature.
3. Turn the upper knob to "ON".
4. Both the bottom and top elements are on. However the primary heat comes from the bottom element.
5. **When baking is finished turn the upper knob to "OFF" and the lower knob to position "●".**

NOTE: - We do not recommend the use of glass covers on casseroles. Glass cooking dishes should never be closer than one inch from the heating element.

- **During the bake and toast function, do not put the multi-purpose oven tray (or any other accessory/container) directly on the lower heating element.**

HELPFUL BAKING HINTS

To obtain best performance from this toaster-oven-broiler:

- Do not overfill the oven. Whenever possible, place foods in center of oven.
- Avoid opening the door too frequently to prevent heat loss.
- Foil may be used to cover the baking dish or pan. Be sure the ends of foil are tucked closely against the edge of the baking dish/pan.

TOP BROWNING

Top Browning is ideal for melting, crisping and toasting food surfaces. Use it for open face sandwiches, pre-buttered muffins or browning cooked casseroles.

1. Place the food on the oven tray and place on the wire rack (position 2 - please see page 3).
2. Close the door, set the lower knob to "BROIL" and the upper knob to "MEDIUM".
3. When experimenting with new uses, watch the food to avoid overbrowning. If necessary the browning cycle can be shortened by turning the upper knob to a lighter setting.
4. A ring indicates the end of the set time. The top browning cycle has been completed. The heating elements will shut off automatically.
6. When the browning cycle has been completed, turn the lower knob to position "●".

3) INSTRUCTIONS FOR BROILING

Always use the multi-purpose oven tray with the wire rack for broiling. No preheating of the broiler is necessary.

Do not leave the broiler unattended when in use. Before using the broiler for the first time and after use, wash the tray and the rack with warm, sudsy water. Do not cover the oven wire rack with foil. This prevents fat and oils from draining, causing spatter and smoking, and also restricts air circulation for proper ventilation.

BROILING

1. Place the accessories as follows:

- **If the oven is not provided with the broiling rack**

- Insert the wire rack in position 3 or 4 (please see page 3).
- Place the multi-purpose oven tray directly on the lower heating element.
- Put the food to be broiled on the wire rack.

- **If the oven is provided with the broiling rack**

- Put the broiling rack inside the multi-purpose oven tray, as shown in fig. 1.
- Place the food to be broiled on the broiling rack.
- Insert the wire rack in position 5 or 6 (please see page 3) and then put the broiling assembly with the food on the wire rack.

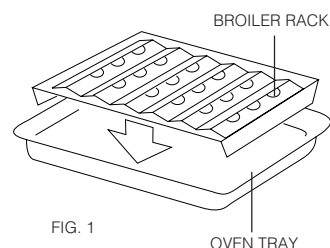

Always allow 1" between food and upper heating element.

2. Leave the oven door half open, as shown in fig. 2
3. Turn the lower knob to "BROIL".
4. Turn the upper knob to "ON".
5. When broiling is finished, turn the upper knob to "OFF" and the lower knob to position "●". Care should be taken when removing the broiler pan and disposing of the grease collected while broiling.

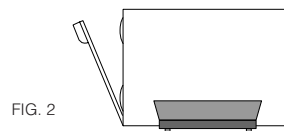

NOTE: While smoke is an inherent characteristic of good broiling, the following tips should eliminate or greatly reduce smoking.

- Trim excess fat from meat and score the edges to prevent curling.
- For best results, thaw frozen meats before broiling. These two precautions will reduce or eliminate smoke from the broiler.
- Placing the food on the rack allows the juices and fat to drip into the oven tray and decreases spattering while broiling.

- If frozen steaks and chops are broiled, allow 1½ to 2 times the required broiling time as that required for unfrozen meat.
- If grease “pops” during broiling, turn the temperature control dial to a lower setting.
- Remove grease from the tray and wash the tray and rack after use.
- The broiler should be cleaned inside after each use. Too much grease accumulation causes smoking. Use any non-abrasive cleaner and hot water.
- For very thick steaks and other thick foods, we recommend using the lower shelf position.

4) DIRECTIONS FOR AUTOMATIC TOASTING

- The capacity of the wire rack is such as to allow the toasting of 6 slices of bread at the same time. In any case better results are obtained with 4 slices.
- For toasting, place the slices of bread as shown below:

Toasting one slice Toasting two slices Toasting four slices Toasting six slices

For consecutive toasting, turn the toast colour selector (upper knob) dial to a lower setting.

INSTRUCTIONS FOR TOASTING

Always use the oven wire rack for toasting bread, sandwiches, English muffins, shelf foods and frozen waffles automatically.

1. Place the wire rack in upper shelf position (position 7 for toast, or position 8 for toasted sandwiches - please see page 3).
2. Center the food to be toasted on the wire rack. Close the door.
3. Turn the lower knob to “TOAST”. When toasting, both the top and bottom heating elements switch on to brown both sides of the food at the same time.
Condensation may build up on the inside of the glass door. This is normal. The condensation will evaporate during the toasting cycle.
4. Set the upper knob to the desired brownness.
When using the toaster-oven-broiler for the first time, set the upper knob to a medium setting. Toast a few pieces of bread to check for desired brownness. If necessary, adjust the control to suit your preference.
5. A ring indicates the end of the set time. The toasting cycle has been completed and the heating elements will shut off automatically.

NOTE: This toaster-oven-broiler is capable of toasting in a wide range of colours, automatically from light to dark. However, if you prefer a lighter shade of toast, simply interrupt the automatic toast cycle by turning the upper knob to “OFF”. This will shut the unit off without damaging the oven.

If you prefer a darker shade, restart the toasting cycle by turning the upper knob clockwise until the desired colour is obtained.

Then switch off manually as described earlier.

HINTS FOR TOASTING SUCCESS

Heavier breads and frozen breads will require a darker setting. One slice of bread will require a lighter setting than several slices.

CLEANING AND MAINTENANCE

Always unplug the toaster-oven-broiler and allow it to cool before cleaning. This unit has been designed and engineered with your safety in mind. To assure maximum safe operation, keep unit clean free of grease and build up of food particles.

1. Remove the wire oven rack.
2. To clean the inside walls use a damp cloth and a mild liquid soap solution. Never use harsh abrasives, corrosive products or spray detergents.

Note: Do not clean interior with metal scouring pads. Pieces can break off and touch electrical parts, creating risk of electrical shock.

3. To clean the glass door, use a glass cleaner or a damp cloth. Wipe dry with a clean cloth.
4. To clean the exterior finish, use a damp, sudsy cloth. For stubborn stains, a non-abrasive liquid cleaner or spray glass cleaner may be used. Do not use metal scouring pads, as they might mar the finish. Always remove cleaning agents by polishing with a dry cloth.
5. The wire rack, the oven tray and the broiler rack (if provided), can be washed as other kitchen ware.

Cleaning the bottom of the oven

To clean the bottom of the oven, open the access panel by pressing the latch spring then pull the access panel downwards (see fig. A/B). Place the oven on its rear panel. This will make cleaning easier.

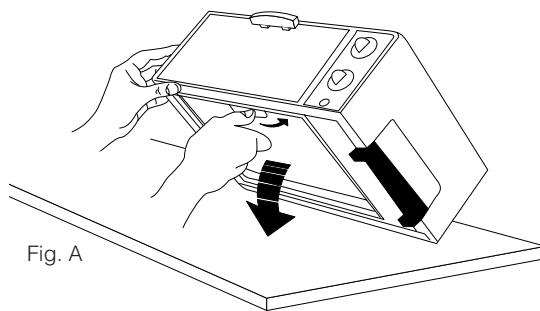

Fig. A

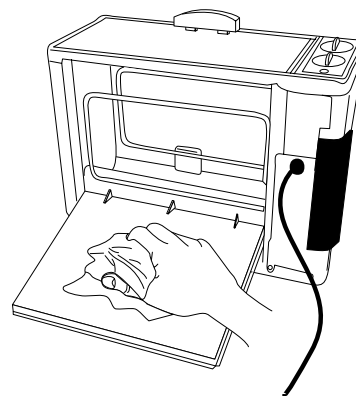

Fig. B

Clean the oven floor after use to avoid build-up of residue, as this will affect the cooking performance. Brush off crumbs or wipe the oven floor with a damp cloth. For stubborn stains, use a nylon or plastic scouring pad or a non-caustic cleaner. Dry thoroughly before closing.

After cleaning, close the access pane and check that it is locked securely into position.

OTHER SERVICING

Any servicing requiring disassembly should be performed by an authorized service representative.



Limited Warranty

What Does This Warranty Cover? We warrant each appliance to be free from defects in material and workmanship. Our obligation under this warranty is limited to replacement or repair, free of charge at our factory or authorized service centers, of any defective part or parts thereof other than parts damaged in transit, which shall be returned to us, transportation prepaid. This warranty shall apply only if the appliance is used in accordance with the factory directions which accompany it, and on an Alternating Current (AC) circuit.

How Long Does The Coverage Last? This warranty runs for one year from the date of delivery and applies only to the original purchaser for use.

What Does This Warranty Not Cover? This warranty does not cover defects or damage of the appliance which result from repairs or alterations to the appliance outside our factory or authorized service centers, nor shall it apply to any appliance which has been subject to abuse, misuse, negligence or accidents. Also, consequential and incidental damages resulting from the use of this product or arising out of any breach of contract or breach of this warranty are not recoverable under this warranty. Some states do not allow the exclusion or limitation of incidental or consequential damages, so the above limitation may not apply to you.

How Do You Get Service? If repairs become necessary or spare parts are needed, please write to:

De' Longhi America Inc.
625, Washington Avenue
Carlstadt N.J. 07072
or call Service Tel. No. 1-800-322-3848

De' Longhi CANADA
1040 Ronsa Court
MISSISSAUGA, ONTARIO
L4W 3Y4 CANADA

The above warranty is in lieu of all other express warranties and representations. All implied warranties are limited to the applicable warranty period set forth above. This limitation does apply if you enter into an extended warranty with De' Longhi. Some states do not allow limitations on how long an implied warranty lasts, so the above exclusions may not apply to you. De' Longhi does not authorize any other person or company to assume for it any liability in connection with the sale or use of its appliance.

How Does State Law Apply? This warranty gives you specific legal rights, and you may also have other rights which vary from state to state.