

This Owner's Manual is provided and hosted by [Appliance Factory Parts](#).

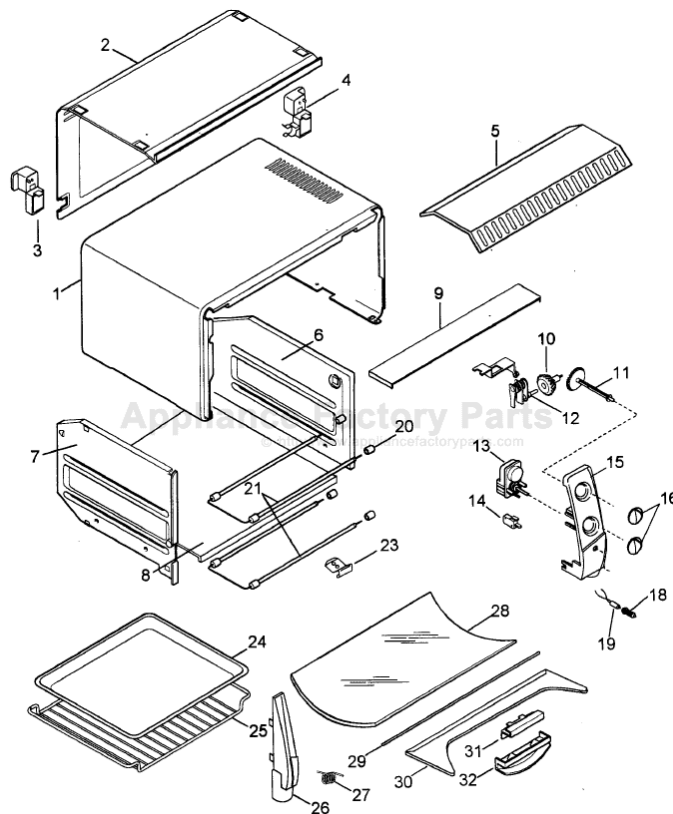

DE'LONGHI UX420 Owner's Manual

[Shop genuine replacement parts for DE'LONGHI UX420](#)



[Find Your DE'LONGHI Oven Parts - Select From 110 Models](#)

----- Manual continues below -----



DIRECTIONS FOR USE (Page 3)

Toaster-Oven-Broiler

De' Longhi products are the finest and most versatile products available. Please read this booklet carefully to ensure that you obtain the fullest benefit from your appliance.

MODE D'EMPLOI (Page 11)

grille- pain - four - grill



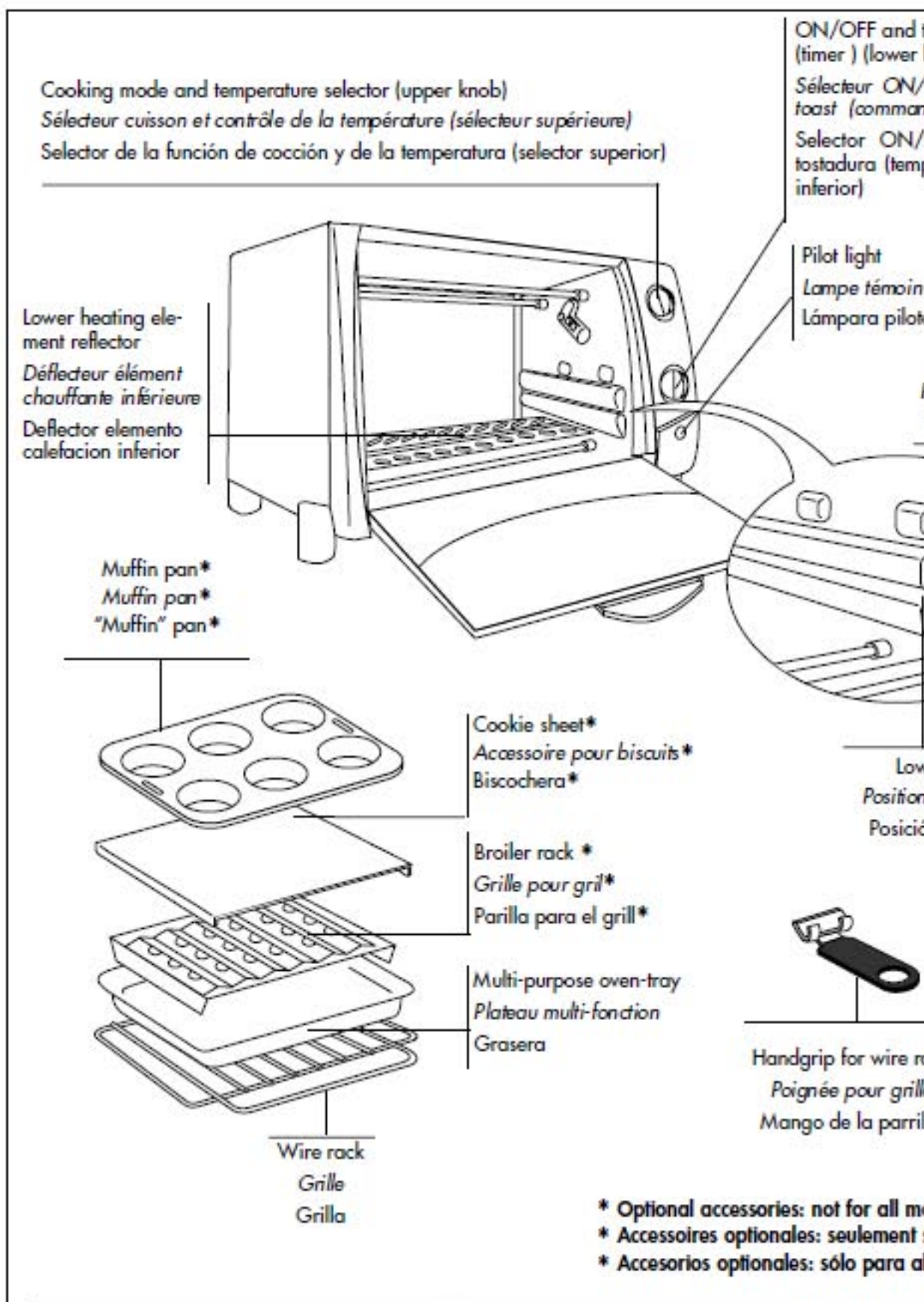







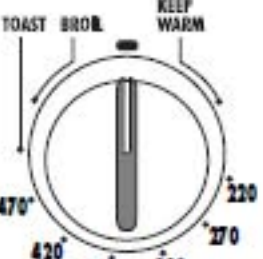

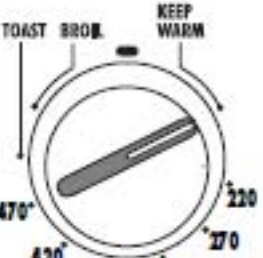

Les produits De' Longhi sont les meilleurs et les plus polyvalents électroménagers disponibles dans le commerce. Nous vous prions de bien vouloir lire attentivement ce mode d'emploi.

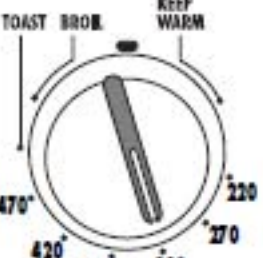

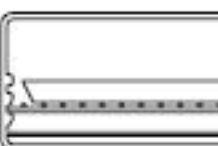
If Your oven is provided with a handgrip:

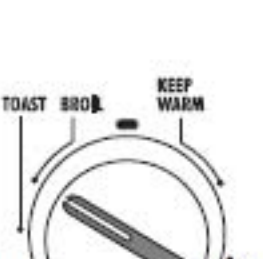

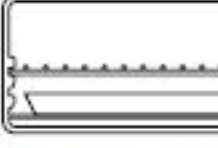
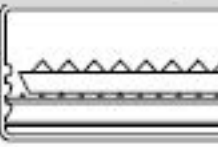
SUMMARY OF OPERATION

Program/ cooking mode	ON/OFF and toast color selector (lower knob)	Cooking mode and temperature selector (upper knob)	Indicator light	Position of oven tray
OFF			 OFF	
KEEP WARM			 ON	 Wire rack
BAKE			 ON	 Oven tray on the the l
BROIL			 ON	 Oven tray placed on reflector and wire rack If Your oven is prov 
				





IMPORTANT SAFEGUARDS

When using electrical appliances, basic safety precautions should always be the following:

1. **READ ALL INSTRUCTIONS.**
2. Do not touch hot surfaces. Use handles or dials.
3. Before using this appliance, place it two to four inches away from the wall or counter top. Remove any object that may have been placed on top of the appliance on surfaces where heat may cause a problem.
4. To protect against electrical shock, do not place unit in or under water. See instructions.
5. Close supervision is necessary when the appliance is used by or near children and the door becomes very hot.
6. **Unplug from outlet when not in use and before cleaning.** Always turn the On/Off knob to "OFF" and the temperature dial (upper knob) to "—" before unplugging before putting on or taking off parts.
7. Do not operate any appliance with a damaged cord or plug or after the appliance or has been damaged in any manner. Return appliance to the nearest authorized service center for examination, repair or adjustment.
8. The use of accessory attachments not recommended by the appliance manufacturer is prohibited.
9. Do not use outdoors.
10. Do not let cord hang over edge of table or counter, or touch hot surfaces.
11. Do not place on or near a hot gas or electric burner.
12. Extreme caution must be used when moving an appliance containing hot oil or grease.
13. If the plug gets hot, please call a qualified electrician.
14. Do not use this appliance for other than intended use.
15. Use extreme caution when removing the oven tray or disposing of hot grease.
16. Do not clean with metal scouring pads. Pieces can break off the pad and touch the heating element, creating a risk of electric shock.
17. To assure safe operation, oversized foods or utensils must not be inserted into the oven.
18. A fire may occur if this appliance is covered or touching flammable material, draperies, walls, etc., when in operation.
19. **CAUTION: Never leave the toaster-oven-broiler unattended when in use (especially broiling and toasting).**
20. When broiling, the oven-tray, other optional accessories (if provided) and wiring must be used according to the instructions on page 7.
21. Extreme caution should be exercised when using containers other than oven proof ceramic.
22. Do not store any materials, other than the manufacturer's recommended accessories, in the oven when not in use.
23. Do not place any of the following materials in the oven or on top of the oven when in use: cardboard, plastic, etc.
24. Do not cover any part of the oven with metal foil. This will cause overheating and damage to the appliance.





- Your product is equipped with a polarized alternating current line plug (a plug wider than the other). This plug will fit into the power outlet only one way. The plug will not fit if you are unable to insert the plug fully into the outlet, try reversing the plug. If the plug still fail to fit, contact your electrician to replace your obsolete outlet. Do not do the repair in the name of the polarized plug.
- Plug the cord into a 120 volt AC outlet.
- The cord length of this product has been selected to reduce the possibility of tripping over a longer cord. If more cord length is needed, an extension cord may be used. It must be rated no less than 15 amps., 120 volts, and have Underwriters Laboratories approval.
- A six feet long, 15 amp. extension cord may be purchased from your local hardware store. When using a longer cord, be sure not to let it drape over the work surface where someone could accidentally pull or trip over it.
- Handle the cord carefully for longer life; avoid jerking or straining the cord at electrical connections.

- **Note:**
Initial start up operation may result in minimal smell and smoke (about 15 minutes). It is due to the protective substance on heating elements which protects them from oxidation effects during shipping from factory.

COOKING PROGRAMMES

The pilot lamp lights when the appliance is plugged into the main socket and switches on, which means that the oven has reached the selected temperature.

Before using the oven for the first time and after use, wash the tray and the rack with warm water.

1) HOW TO KEEP FOOD WARM

Place the food to be kept warm on the wire rack inserted in the lower slot (please turn the lower knob counterclockwise to "OVEN/BROIL" position. Turn the upper knob to "WARM". This feature is designed to keep foods warm, after they are cooked for short periods without overcooking. We do not recommend keeping foods warm for prolonged periods. Use this feature to reheat frozen or cold foods. **Once the "keep warm" function is no longer needed, turn the upper knob to "OFF" and the lower knob to "OFF".**

2) INSTRUCTIONS FOR BAKING

You can bake foods in your oven, just as in your regular oven. Casseroles or baked meats may be placed directly on the removable wire rack. Use the convenient oven tray provided for





Helpful baking hints

To obtain best performance from this toaster-oven-broiler:

- Do not overfill the oven. Whenever possible, place foods in center of oven.
- Avoid opening the door too frequently to prevent heat loss.
- Foil may be used to cover the baking dish or pan. Be sure the ends of foil are tucked under the edge of the baking dish/pan.

Optional accessories for baking

- **Cookie sheet:** must be placed directly on the wire rack as shown in the figure, the rack inserted in the lower slot. This is necessary to cook cookies and pastry.
- **Muffin pan:** butter and flour the molds before filling them. Pre-heat the oven to the desired temperature before inserting the muffin pan on the wire rack in the lower slot.



3) INSTRUCTIONS FOR BROILING

Always use the multi-purpose oven tray with the wire rack for broiling. No preheating is necessary.

Do not leave the broiler unattended when in use. Do not cover the oven wire rack. This prevents fat and oils from draining, causing spatter and smoking, and also restricts proper ventilation.

Broiling

1. Place the accessories as follows:

- **If the oven is not provided with the broiler rack**
 - Insert the wire rack in the upper slot (please see page 4).
 - Place the multi-purpose oven tray directly on the lower heating element reflector (please see page 4).
 - Put the food to be broiled on the wire rack.
- **If the oven is provided with the broiler rack**
 - Put the broiling rack inside the multi-purpose oven tray, as shown in figure
 - Place the food to be broiled on the broiling rack.
 - Insert the wire rack in the lower slot (please see page 4) and then put the broiling assembly with the food on the wire rack.



Always allow 1" between food and upper heating element.

In order to reduce bad smell, smoke and spattering: before starting the broiling, place a glass of water in the multi-purpose oven tray.

2. Turn the upper knob clockwise to "BROIL".
3. Turn the lower knob counterclockwise to "OVEN/BROIL".
4. When broiling is finished, turn the lower knob to "Off" and the upper knob





- If frozen steaks and chops are broiled, allow 1½ to 2 times the required broiling time required for unfrozen meat.
- Remove grease from the tray and wash the tray and rack after use.
- The broiler should be cleaned inside after each use. Too much grease accumulating can cause smoking. Use any non-abrasive cleaner and hot water.

Top Browning

Top Browning is ideal for melting, crisping and toasting food surfaces. Use it for melting cheese on sandwiches, pre-buttered muffins or browning cooked casseroles.

1. Place the food in the oven tray and place the tray on the wire rack insert (please see page 3).
2. Close the door, set the upper knob clockwise to "BROIL" and the lower knob to "BROWN".
3. When experimenting with new uses, watch the food to avoid overbrowning. The top browning cycle can be shortened by turning the lower knob to a lighter setting.
4. A ring indicates the end of the set time. The top browning cycle has been completed. The oven elements will shut off automatically.
5. When the browning cycle has been completed, turn the upper knob to position "OFF".

4) DIRECTIONS FOR AUTOMATIC TOASTING

- The capacity of the wire rack is such as to allow the toasting of 4 slices of bread.
- For toasting, place the slices of bread as shown below:

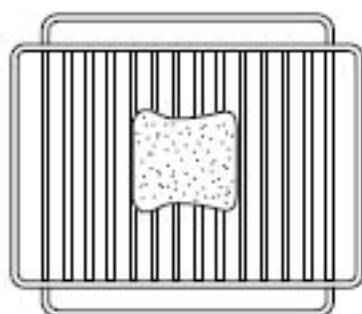

Toasting one slice

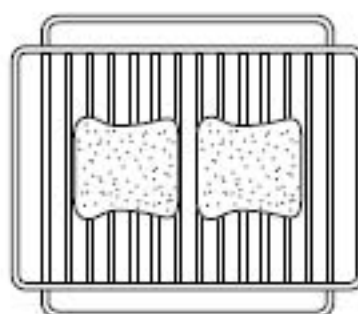

Toasting two slices

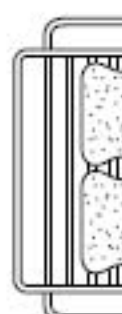

Toasting four slices

Note: For consecutive toasting, turn the toast color selector (lower knob) to a lower setting.

Instructions for toasting

Always use the oven wire rack for toasting bread, sandwiches, English muffins, scones and waffles automatically.

1. Place the wire rack in the lower slot (please see page 4).
2. Center the food to be toasted on the wire rack. Close the door.
3. Turn the upper knob clockwise to "TOAST". When toasting, both the top and bottom oven elements switch on to brown both sides of the food at the same time.



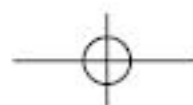

If you prefer a darker shade, restart the toasting cycle by turning the lever until the desired color is obtained.

Then switch off manually as described earlier.

- Condensation may build up on the inside of the glass door. This is normal and will evaporate during the toasting cycle.
- Heavier breads and frozen breads will require a darker setting. One slice requires a lighter setting than several slices.

CLEANING AND MAINTENANCE

Always unplug the toaster-oven-broiler and allow it to cool before cleaning. This appliance is designed and engineered with your safety in mind. To assure maximum safe operation, keep the interior free of grease and build up of food particles.

1. Remove the wire oven rack.
2. To clean the inside walls use a damp cloth and a mild liquid soap solution. Never use abrasives, corrosive products or spray detergents.

Note: Do not clean interior with metal scouring pads. Pieces can break off and become sharp parts, creating risk of electrical shock.

3. To clean the glass door, use a glass cleaner or a damp cloth. Wipe dry with a clean, dry cloth.
4. To clean the exterior finish, use a damp, sudsy cloth. For stubborn stains, a mild abrasive cleaner or spray glass cleaner may be used. Do not use metal scouring pads, as they will damage the finish. Always remove cleaning agents by polishing with a dry cloth.
5. The wire rack, the oven tray and the optional accessories (if provided), can be cleaned with any kitchen ware.

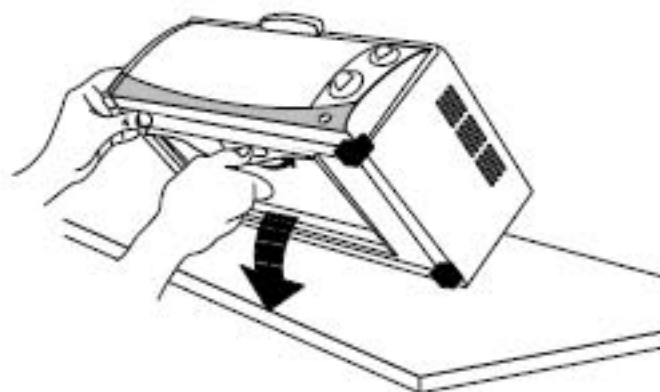

FIG. A



FIG. B

Cleaning the bottom of the oven

To clean the bottom of the oven, pull the access panel downwards (see fig. A/B).





DeLonghi

Limited Warranty

What Does This Warranty Cover? We warrant each Espresso Coffee Machine to be free of defects in material and workmanship. Our obligation under this warranty is limited to replacement or repair, at no charge at our factory or authorized service centers, of any defective part or parts there of which are damaged in transit, which shall be returned to us, transportation prepaid. This warranty shall be void if the Espresso Coffee Machine is used in accordance with the factory directions which accompany the machine.

How Long Does The Coverage Last? This warranty runs for one year from the date of purchase. It applies only to the original purchaser.

What Does This Warranty Not Cover? This warranty does not cover defects or damages to any Espresso Coffee Machine which result from repairs or alterations to the machine outside our factory or authorized service centers, nor shall it apply to any Espresso Coffee Machine which has been subject to misuse, neglect, negligence or accidents. Also, consequential and incidental damages resulting from the use of the machine or arising out of any breach of contract or breach of this warranty are not recoverable under this warranty. Some states do not allow the exclusion or limitation of incidental or consequential damages, so this limitation may not apply to you.

How Do You Get Service? If repairs become necessary or spare parts are needed, please contact your authorized service center.

De'Longhi America Inc.
Park 80 West Plaza One - 4th floor
Saddle Brook, NJ 07663
or call Service Tel. No. 800-322-3848

De' Longhi
104
MISSISSAUGA
L4W

The above warranty is in lieu of all other express warranties and representations; All implied warranties are limited to the applicable warranty period set forth above. This limitation does apply if you enter into an express warranty with De'Longhi. Some states do not allow limitations on how long an implied warranty lasts. This warranty does not cover the above exclusions connection with the sale or use of its Espresso Coffee Machine.

How Does State Law Apply? This warranty gives you specific legal rights, and you may have other legal rights which vary from state to state.

