

This Owner's Manual is provided and hosted by [Appliance Factory Parts](#).



# DE'LONGHI EO1200B Owner's Manual

[Shop genuine replacement parts for DE'LONGHI  
EO1200B](#)



[Find Your DE'LONGHI Oven Parts - Select From 110 Models](#)

----- Manual continues below -----

# ELECTRIC OVEN FOUR ÉLECTRIQUE HORNO ELÉCTRICO FORNO ELETTRICO

Register this product on-line and receive a free trial issue of Cook's Illustrated. Visit [www.prodregister.com/delonghi](http://www.prodregister.com/delonghi).  
Visit [www.delonghi.com](http://www.delonghi.com) for a list of service centers near you. (U.S. Only)

Enregistrez ce produit en ligne et recevez un numéro gratuit de Cook's Illustrated. Visitez [www.prodregister.com/delonghi](http://www.prodregister.com/delonghi).  
Visitez [www.delonghi.com](http://www.delonghi.com) pour y voir une liste des centres de réparation proches de chez vous. (É.-U. uniquement)

Registre este producto en línea y reciba un ejemplar gratis de Cook's Illustrated. Visite [www.prodregister.com/delonghi](http://www.prodregister.com/delonghi).  
Visite [www.delonghi.com](http://www.delonghi.com) para ver la lista de centros de servicios cercanos a usted. (Solamente en los Estados Unidos)

Registra questo prodotto "on-line" per ricevere una copia omaggio della rivista. Visita [www.prodregister.com/delonghi](http://www.prodregister.com/delonghi).  
Visita [www.delonghi.com](http://www.delonghi.com) per una lista dei centri di servizio a te più vicini. (Solo negli Stati Uniti)

## **Instructions for use**

*Keep these instructions*

## **Mode d'emploi**

*Conservez cette notice*

## **Instrucciones para el uso**

*Repase y guarde estas instrucciones*

## **Istruzioni per l'uso**

*Leggere e conservare queste istruzioni*

## ELECTRICAL CONNECTION

---

Only use a three-pin, 120 Volt, 60 Hz power outlet

### GROUNDING INSTRUCTIONS

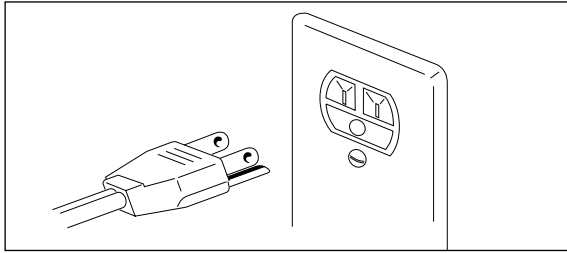

#### MAKE SURE THAT THE PLUG IS CORRECTLY GROUNDED

This appliance must be grounded: in the event of short circuits, the ground connection reduces the risk of electric shock, allowing the electrical current to be dispersed.

This appliance is fitted with a power cable with ground wire.

The plug must be connected to a power outlet that has been correctly installed and grounded.

**WARNING: IMPROPER USE OF THE GROUND WIRE MAY LEAD TO THE RISK OF ELECTRIC SHOCK.**

If you are not sure that the power outlet are properly grounded, contact a qualified electrician.

If an extension cord is required, only use three-wire extension cords with three-pin plugs and sockets that fit the plug on the appliance.

The capacity of the extension cord must be greater than or equal to the rated power input of the appliance.

- The length of the power cable for this appliance has been devised so as to avoid the possibility of tripping on or getting entangled in a long cable.

If a longer cable is required, an extension cord can be used with a rated capacity not below 15 amps, 120 volt and with UL/CSA approval.

- A six-foot long extension cord, with a 15 amp rating, is available from authorized resellers.

When using an extension cord, make sure it does not hang loose in the work area or where someone may accidentally trip on it or get entangled in it.

- Handle the power cable with care for longer life; avoid pulling or stressing the cable around the connectors to the power outlet and the appliance.

## CONVERSION TABLE

---

°C	°F
120	250
135	275
150	300
163	325
177	350
190	375
205	400
218	425
233	450

## DESCRIPTION OF THE APPLIANCE

- |                                      |  |
|--------------------------------------|--|
| A thermostat knob                    | L crumb tray   |
| B timer knob                         | M top heating element                                |
| C indicator light                    | N interior light (if supplied)                       |
| D function selector knob             | O cookie sheet (if supplied)                         |
| E glass door                         | P muffin pan (if supplied)                           |
| F bottom heating element             | Q broil rack (if supplied)                           |
| G 12" pizza-shaped wire rack         | R rubber pad (if supplied)                           |
| H bake pan                           | S wire rack insertion/extraction lever (if supplied) |
| I reversible wire rack (if supplied) |  |

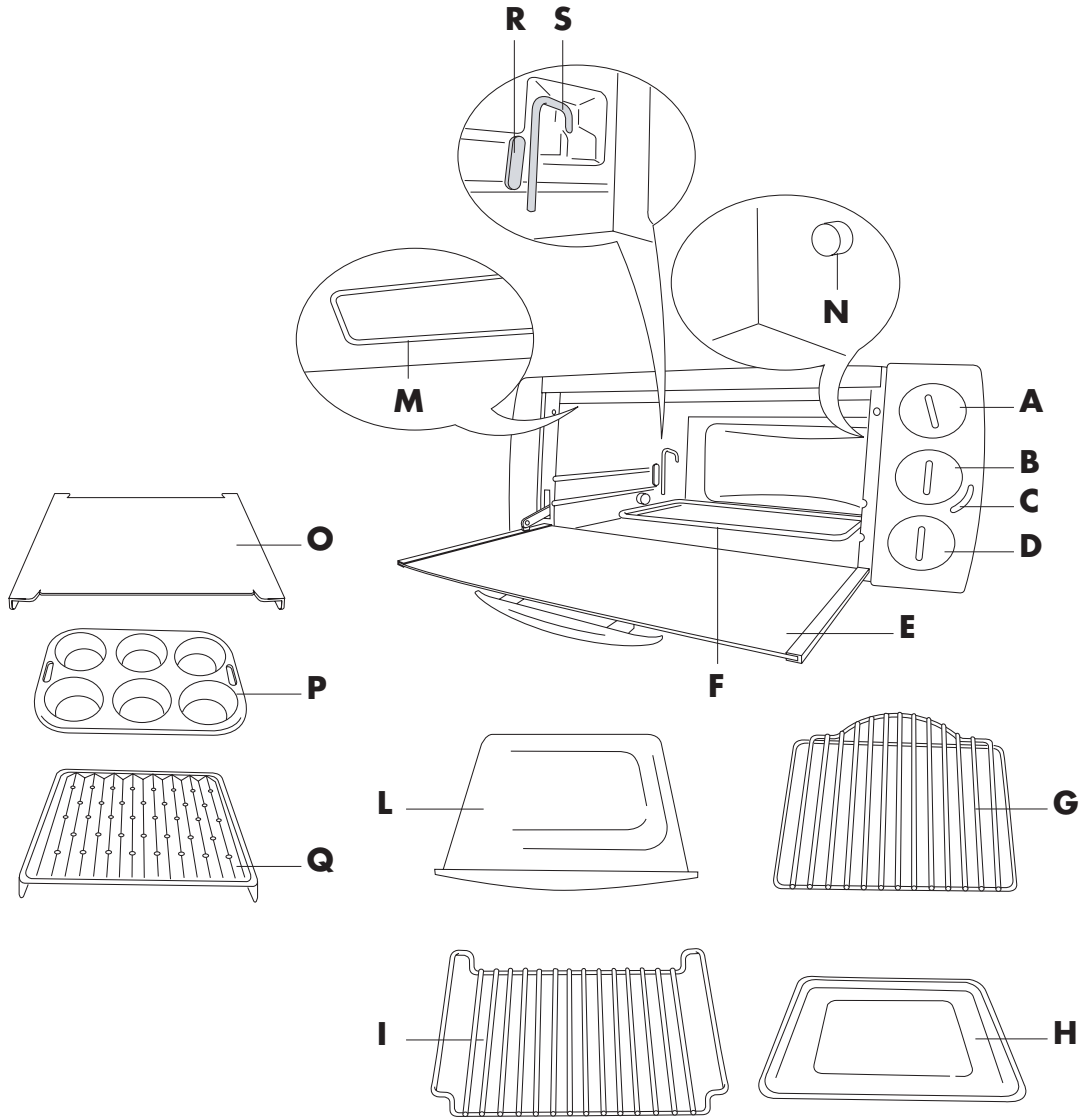

# IMPORTANT WARNINGS

When using electrical appliances, a number of fundamental safety rules must be observed, including the following:

## 1. READ ALL THE INSTRUCTIONS

2. Do not touch the hot surfaces. Only use the knobs or handles to operate the appliance.
3. Before using the appliance, move it 5/10 cm (2") away from the wall and any other object that is on the same surface. Remove any objects located above the appliance. Do not use on surfaces that may be damaged by the heat.
4. To avoid electric shock, do not immerse the appliance in water. See the instructions for cleaning.
5. If the appliance is used when children are around, pay careful attention to the metal walls of the oven and the door, which become very hot.  
The appliance must not be used by children without supervision.  
Make sure that children do not play with the appliance.
6. Unplug the appliance from the power outlet when this is not being used or before cleaning it. Always place the Timer knob in the "OFF" position and the thermostat knob in the "•" position before unplugging the appliance.  
Wait for the appliance to cool down before fitting or removing any parts.
7. Never operate the appliance with the cable or the plug damaged, if any malfunctions have occurred, or if the appliance has been damaged in any way.  
Take the appliance to the nearest authorized service center, which will inspect it and, if necessary, will adjust or repair it.
8. The use of accessories that are not recommended by the manufacturer may cause injuries.
9. Do not use outdoors.
10. Do not let the power cable hang from the counter or come into contact with hot surfaces.
11. Do not place the appliance above or near a gas or electric cooker.
12. Use maximum care when moving the appliance if it contains hot oil or other hot liquids.
13. If the plug heats up, contact a qualified electrician.
14. Do not use this appliance for purposes other than those it has been designed for.
15. Use maximum care when removing the bake pan or throwing out the hot fat.
16. Do not use metal sponges to clean the appliance, small particles may be detached that cause electric shocks.
17. To ensure the safe operation of the appliance, never introduce foods or utensils that are too large for the oven.
18. If the appliance, when operating, is covered by or comes into contact with flammable materials, such as curtains, fabrics or wall coverings etc., these may catch fire.
19. **WARNING: Never leave the appliance unattended when operating (especially when broiling or toasting).**
20. When broiling, the bake pan and the wire racks must be used as described in the instructions on page 10.
21. Extreme care must be taken when using containers made from materials other than glass, metal or oven-proof ceramics.
22. Do not place any objects in the oven when this is not being used, apart from the accessories recommended by the manufacturer.
23. Do not place any of the following materials into or on top of the oven: paper, cardboard, plastic and the like.
24. Do not cover parts of the oven with metal foil, to avoid overheating.
25. To switch the appliance off, turn the Timer knob to the "OFF" position and the thermostat knob to "•".

**This product is designed exclusively for household use**



## KEEP THESE INSTRUCTIONS

**WARNING: After having removed the appliance from its packaging, check that the door is intact.**

The door is made from glass and is therefore fragile. If it is visibly chipped, scored or scratched, it should be replaced.

While using, cleaning or moving the appliance, avoid slamming or knocking the door. Do not pour cold liquid onto the glass while the appliance is hot.

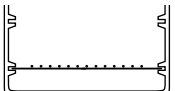
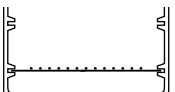
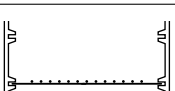
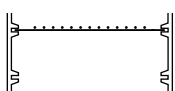
**SUMMARY TABLE**

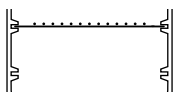
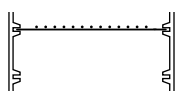
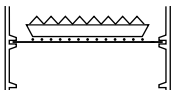
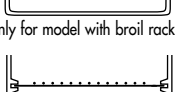
Program	Function selector knob position	Thermostat knob position	Wire rack and accessory position	Notes/Tips
Defrost (*)	DEFROST	●		-
Delicate cooking	SLOW BAKE	250°F - 430°F		-
Keeping warm	BAKE/TOAST	KEEP WARM		-
Convection oven cooking (*)	FAN & BAKE	250°F - 430°F		Ideal for lasagna, meat, pizza, cakes in general, foods that should be crunchy on the surface ("au gratin") and bread. For details on how to use the accessories, refer to the tips in the table on pages 7-8.
				
Traditional oven cooking	BAKE/TOAST	250°F - 430°F	 	Ideal for cooking stuffed vegetables, fish, plum cakes and small poultry. For details on how to use the accessories, refer to the table on page 8.
Toast	BAKE/TOAST	TOAST/BROIL		Ideal for toasting slices of bread
Grilling	BROIL	TOAST/BROIL	 only for model with broil rack	Ideal for all types of traditional grilling: hamburgers, hot dogs, kebabs, etc. and toasting bread.
			 only for model without broil rack	

(\*) only on some models

## USING THE CONTROLS

### Thermostat knob (A)

Select the desired temperature, as follows:

- To defrost (\*) (see page 7): .....Thermostat knob in the "●" position.
- To keep food warm (see page 7): .....Thermostat knob in the "KEEP WARM" position.
- For convection oven cooking (\*) or traditional oven cooking (see page 7-8): .....Thermostat knob from 250°F to 430°F.
- To toast (see page 9): .....Thermostat knob in the "TOAST/BROIL" position.
- For all types of grilling (see page 10): .....Thermostat knob in the "TOAST/BROIL" position.

### Timer knob (B)

- To switch the oven on: .....Turn the knob to the "ON" position
- To set the toasting function: .....Select "LIGHT", "MEDIUM" or "DARK"
- To switch the oven off: .....Return the knob to the "OFF" position.

### Function selector knob (D)

This knob is used to select the cooking functions available, that is:

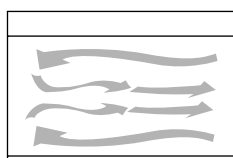

DEFROST (\*)  
(ventilation only)

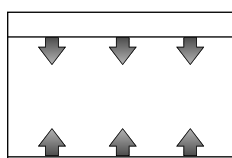

BAKE/TOAST  
(only top heating element  
and bottom heating element  
on)

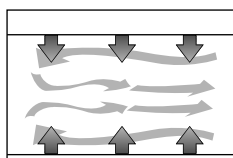

FAN & BAKE (\*)  
(top heating element, bottom heating  
element and ventilation on)

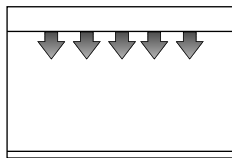

BROIL  
(only top heating element on  
at maximum power)

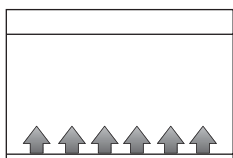

SLOW BAKE  
(only bottom heating element  
on)

### Indicator light (C)

The light on means that the oven is on.

### Interior light (N) (\*)

When the oven is on, the light inside the oven is always on.

To replace the bulb, proceed as follows: unplug the appliance from the power outlet, unscrew the glass cover and replace the bulb with a new one of the same type (resistant to high temperatures) and then replace the glass cover.

(\*) only on some models

## USING THE OVEN

---

### General tips

- When cooking with the convection oven, traditional oven and grilling, always preheat the oven for 5 minutes to the set temperature to achieve the best results.
- The cooking times depend on the quality of the products, on the temperature of the food and on personal tastes. The times indicated in the table are subject to variation, and do not include the time required to preheat the oven.
- To cook frozen foods refer to the recommended times on the product packaging.

### Wire rack insertion/extraction lever (\*)

If the oven is equipped with a wire rack insertion/extraction lever, follow these simple instructions:

- **To insert the wire rack:** push the wire rack towards the back of the oven past the rubber pad on the left of the oven until it clicks into place. When the door is closed, the wire rack automatically moves into position.
- **To remove the wire rack:** open the door. The wire rack is automatically ejected by a couple of centimeters. Grip it with an oven mitt and pull towards you.

### Defrost (\*)

For proper defrosting in a short time, proceed as follows:

- Turn the function selector knob (D) to the "DEFROST" position.
- Turn the thermostat knob (A) to the "•" position.
- Turn the Timer knob (B) to the "ON" position.
- Place the flat wire rack (G) in the lower guide and rest the food to be defrosted on a tray on the wire rack, then close the door.
- When defrosting is completed, turn the Timer knob (B) manually to the "OFF" position.

Example of defrosting: 1 kg/2.2 lbs. of meat, 80-90 minutes without turning it over.

### Slow bake

Ideal for pastry and cakes. Good results are also achieved when completing the cooking of the bottom of the foods or for cooking that requires heat above all at the bottom.

- Place the wire rack (with a pan on it) in the lower guide, as shown in the figure on page 5.
- Turn the function selector knob (D) to the "SLOW BAKE" position.
- Select the required temperature using the thermostat knob (A).
- Turn the Timer knob (B) to the "ON" position; when cooking is completed turn the Timer knob (B) manually to the "OFF" position.

### Keep warm

- Turn the thermostat knob (A) to the "KEEP WARM" position.
- Turn the function selector knob (D) to the "BAKE/TOAST" position.
- Turn the Timer knob (B) to the "ON" position.
- Place the flat wire rack (G) in the lower guide and rest the dish with the food on the rack.
- To terminate the operation, turn the Timer knob (B) manually to the "OFF" position.

It is recommended not to leave the foods in the oven for too long, as these may dry out.

### Fan & bake (\*)

This function is ideal for baking excellent pizzas, lasagna, "au gratin" dishes, all types of meat dishes (apart from small poultry), roast potatoes, cakes in general and bread.

It is also suitable for cooking different foods on two levels at the same time. Proceed as follows:

- Place the flat wire rack (G) in the position shown in the table.
- Turn the function selector knob (D) to the "FAN & BAKE" position.
- Select the required temperature by turning the thermostat knob (A).
- Turn the Timer knob (B) to the "ON" position.
- After having pre-heated the oven for 5 minutes, place the food to be cooked inside.
- When cooking is completed, turn the Timer knob (B) manually to the "OFF" position.

(\*) only on some models

Program	Thermostat knob	Times	wire rack position	Comments and tips
Macaroni "au gratin" 1 kg/2.2 lb	430°	20 min.	lower	Turn the bake pan halfway through cooking
Lasagna 1 kg/2.2 lb	430°	20 min.	"	Use an ovenproof dish, turn after 10 min.
Pizza 500 g/1.1 lb	430°	17 min.	"	Use the bake pan.
Chicken 1 kg/2.2 lb	400°	70-80 min.	"	Use the bake pan, turn after around 38 min.
Roast pork 900 g/2 lb	400°	70 min.	"	Use the bake pan, turn after around 30 min.
Meatballs 650 g/1.4 lb	350°	55 min.	"	Use the bake pan, mix twice.
Roast potatoes 500 g/1.1 lb	400°	50 min.	"	Use a cake dish.
Jam tarts 700 g/1.5 lb	350°	40 min.	"	Use a cake dish.
Strudel 1 kg/2.2 lb	350°	40 min.	"	Use a cake dish.
Walnut cakes 800 g/1.8 lb	350°	35 min.	"	Use a cake dish.
Biscuits (shortbread) 100 g/0.2 lb	350°	14 min.	"	Use a cake dish.
Bread 500 g/1.1 lb	400°	25 min.	"	Use the bake pan greased with oil.

### Bake/toast

This function is ideal for all types of fish, stuffed vegetables, cakes with whipped egg-whites and cakes that require long cooking times (over 60 min.).

Proceed as follows:

- Place the wire rack in the position shown in the table.
- Turn the function selector knob (D) to the "BAKE/TOAST" position.
- Select the required temperature by turning the thermostat knob (A).
- Turn the Timer knob (B) to the "ON" position.
- After having pre-heated the oven for 5 minutes, place the food inside.
- When cooking is completed, turn the Timer knob (B) manually to the "OFF" position.

Program	Thermostat knob	Times	wire rack position	Comments and tips
Quail (3)	430°	44 min.	lower	Use the bake pan, turn after 24 minutes.
Trout 500 g/1.1 lb	400°	35 min.	"	Use the bake pan, turn after 16 minutes.
Stuffed calamari 450 g/1 lb	400°	30 min.	"	Use an ovenproof dish, turn halfway through cooking.
Tomatoes "au gratin" 550 g/1.2 lb	400°	40 min.	"	Use the bake pan greased with oil and turn after 20 min.
Zucchini with tuna 750 g/1.6 lb	400°	40 min.	"	Use the bake pan; add oil, the tomatoes and water; turn the bake pan after 20 min.
Plum cakes 1 kg/2.2 lb	350°	75 min.	"	Use a mold and turn halfway through cooking.
Meringues	250°	50 min.	"	Use the bake pan greased with oil. Let them rest for at least 1 day before serving.

## Toast

- The dimensions of the wire rack (G) allow six slices of bread to be toasted at the same time. Best results are achieved, however, with four slices at a time.
- To toast the bread, place the slices as shown below:

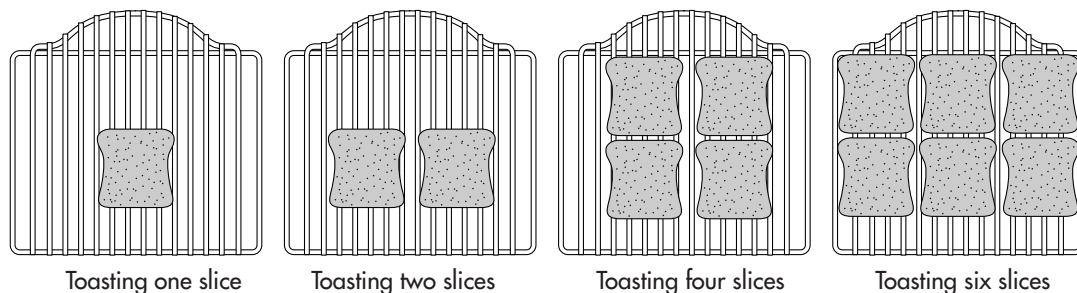

For consecutive uses, reduce the set toasting time.

## Instructions for toasting bread

To automatically toast frozen bread, sandwiches, muffins and waffles, always use the wire rack.

1. Place the wire rack as shown in the table on page 5.
2. Place the food to be toasted in the center of the wire rack. Close the door.
3. Turn the thermostat knob (A) to the "TOAST/BROIL" position and the function selector (D) to the "TOAST/BAKE" position.
4. The Timer knob (B) should be turned clockwise. When using the appliance for the first time, turn the Timer knob (B) to a medium value.  
Toast a few pieces of bread to check the set level. If necessary, adjust the knob as desired.
5. When toasting bread, both the top and bottom heating elements are on to toast both sides at the same time.  
A little condensation may form on the inside of the glass door. This is normal. It will disappear during toasting.
6. An audible signal indicates the end of the set time. The toasting is complete and the heating elements automatically switch off. Turn the thermostat knob (A) to the "•" position.

### Note:

This appliance can automatically perform various degrees of toasting.

If, however, lighter toasting is preferred, simply stop the automatic cycle by turning the Timer knob (B) to the "OFF" position, to switch the oven off, without the risk of damaging it.

For darker toasting re-start the cycle by turning the Timer (B) clockwise until reaching the desired level.

**Then manually turn the thermostat knob and the toast timer knob off, as described previously.**

The best positions for each type of bread can be identified when using the oven regularly.

### Tips for good toasting:

Larger pieces of bread and frozen bread take longer to toast. Just one slice of bread requires a lower setting than for multiple slices.

## Broil

- Place the flat wire rack (G) in the upper guide.
- Turn the function selector knob (D) to the BROIL position.
- **If your oven features the broil rack (Q):** place the food to be grilled on the broil rack (Q) inserted on the bake pan (H), and place them together on the flat wire rack (G).
- **If your oven does not feature the broil rack (Q):** place the food directly on the flat wire rack (G) (the bake pan (H) must be placed over the bottom heating element, to catch any fat that drips).
- Close the door.
- Turn the Timer knob (B) to the "ON" position.
- When cooking is completed, turn the Timer knob (B) manually to the "OFF" position.

Program	Thermostat knob	Times	Wire rack position	Comments and tips
Pork chops (2)	TOAST/BROIL	26 min.	upper	Turn after 14 minutes.
Hot dogs (3)	"	20 min.	"	Turn after 11 minutes.
Hamburgers (2)	"	25 min.	"	Turn after 13 minutes.
Sausages (4)	"	26 min.	"	Turn after 14 minutes.
Kebabs 500 g/1.1 lb	"	26 min.	"	Turn after 8, 15 and 21 minutes.

## Cooking on 2 levels at the same time with the convection oven (\*)

The convection oven function allows different foods to be cooked at the same time, placed on 2 levels.

The heat provided by the 2 heating elements, is distributed inside the oven by the air, circulated by the fan.

In this way, the heat reaches every part of the oven **uniformly and quickly**; the air inside the oven is very dry, preventing the mixing of flavors.

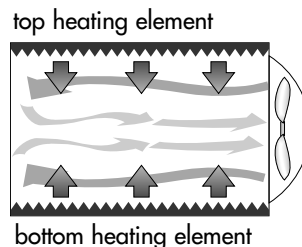

To cook two dishes at the same time, simply observe these simple general rules.

1. The cooking times for recipes cooked at the same time are higher than the times when cooked alone.
2. Around halfway through cooking, **change the position** of the 2 bake pans, placing the top one on the lower wire rack and vice-versa.

In addition, **turn** the bake pans **half-way** around.

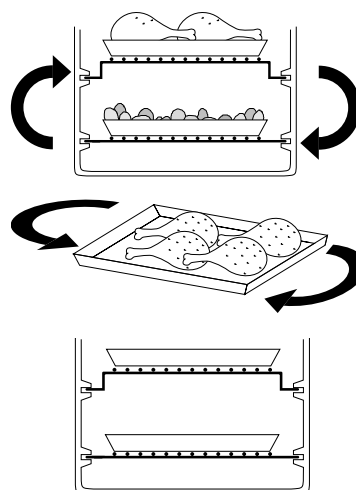

**Note: the wire racks must be positioned as shown in the figure to the side.**

(\*) only on some models

## CLEANING AND MAINTENANCE

Frequent cleaning prevents the formation of smoke and bad odors during cooking. Do not let fat accumulate inside the appliance.

Before any maintenance or cleaning operation, unplug the oven and wait for it to cool down.

Clean the door, the inside walls and the enamel or painted surfaces of the oven with a soap and water solution; dry thoroughly.

To clean the aluminum surfaces on the inside of the oven, never use products that corrode aluminum (detergents in spray cans) and never scrape the walls with sharp objects.

To clean the outside surface always use a damp sponge.

Avoid using abrasive products that may damage the exterior.

Make sure water or liquid soap does not seep into the vents on the top of the oven.

**Never immerse the appliance in water; never wash it under a jet of water.**

All the accessories are washed like normal dishes, either by hand or in the dishwasher.

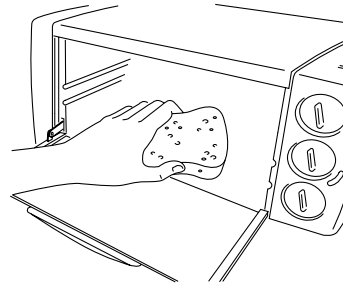
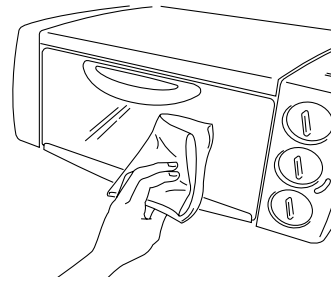

### **If the oven has a crumb tray:**

Remove the tray from the bottom (figure to the side); wash it by hand.

If the dirt is hard to remove, rinse the tray in hot soapy water and if necessary rub it gently, without scratching it.

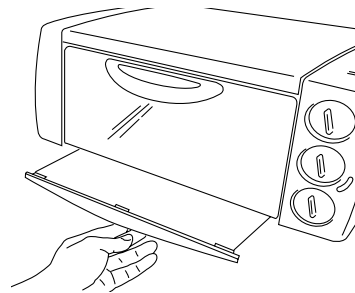

## LIMITED WARRANTY

---

This warranty applies to all products with De'Longhi or Kenwood brand names.

What does the warranty cover?

We warrant each appliance to be free from defects in material and workmanship. Our obligation under this warranty is limited to repair at our factory or authorized service center of any defective parts or part thereof, other than parts damaged in transit. In the event of a products replacement or return, the unit must be returned transportation prepaid. The repaired or new model will be returned at the company expense.

This warranty shall apply only if the appliance is used in accordance with the factory directions, which accompany it, and on an Alternating current ( AC ) circuit.

How long does the coverage last?

This warranty runs for one year ( 1 ) from the purchase date found on your receipt and applies only to the original purchaser for use.

What is not covered by the warranty?

The warranty does not cover defects or damage of the appliance, which result from repairs or alterations to the appliance outside our factory or authorized service centers, nor shall it apply to any appliance, which has been subject to abuse, misuse, negligence or accidents. Also, consequential and incidental damage resulting from the use of this product or arising out of any breach of contract or breach of this warranty are not recoverable under this warranty. Some states do not allow the exclusion or limitation of incidental or consequential damage, so the above limitation may not apply to you.

How do you get service?

If repairs become necessary, see contact information below:

U.S. Residents:

Please contact our toll free hotline at 1-800-322-3848 or log onto our website at [www.delonghi.com](http://www.delonghi.com).

For all accessories, spare parts or replacement parts, please contact our parts division at 1-800-865-6330.

Residents of Canada: Please contact our toll free hotline at 1-888-335-6644 or log onto our website at [www.delonghi.com](http://www.delonghi.com).

Residents of Mexico: Please refer to the Limited Warranty statement for Mexico.

Please refer to the back page of the manual for De'Longhi addresses.

The above warranty is in lieu of all other express warranties and representations. All implied warranties are limited to the applicable warranty period set forth above. This limitation does not apply if you enter into an extended warranty with De'Longhi. Some states do not allow limitations on how long an implied warranty lasts, so the above exclusions may not apply to you. De'Longhi does not authorize any other person or company to assume for it any liability in connection with the sale or use of its appliance.

How does state law apply?

This warranty gives you specific legal rights, and you may also have other rights, which vary from state to state.