

This Owner's Manual is provided and hosted by Appliance Factory Parts.

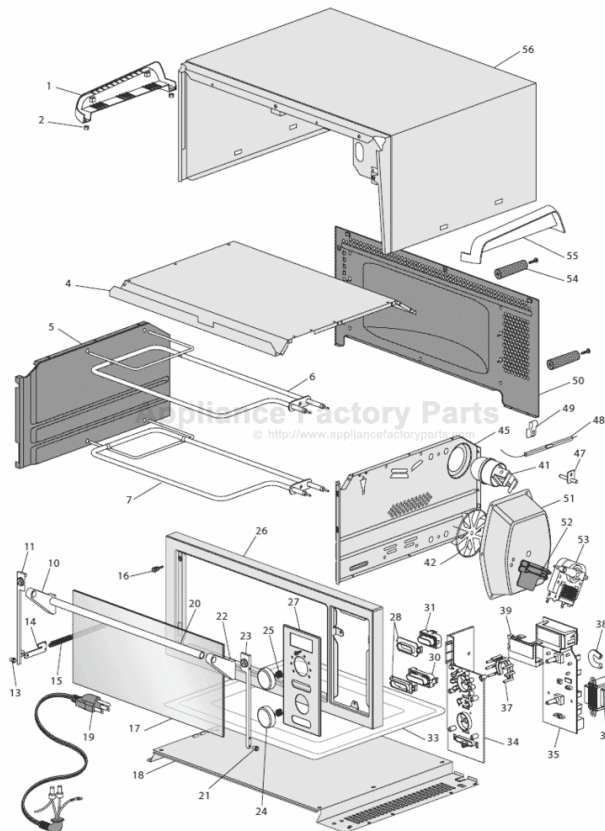

DE'LONGHI DO1289 Owner's Manual

[Shop genuine replacement parts for DE'LONGHI DO1289](#)



[Find Your DE'LONGHI Oven Parts - Select From 110 Models](#)

----- Manual continues below -----

**ELECTRIC OVEN
FOUR ÉLECTRIQUE
HORNO ELÉCTRICO
FORNO ELETTRICO
DO1289**

Register this product on-line and receive a free trial issue of Cook's Illustrated. Visit www.prodregister.com/delonghi.

Visit www.delonghi.com for a list of service centers near you. (U.S. and Canada Only)

Enregistrez ce produit en ligne et recevez un numéro gratuit de Cook's Illustrated. Visitez www.prodregister.com/delonghi.

Visitez www.delonghi.com pour y voir une liste des centres de réparation proches de chez vous. (É.-U. et Canada uniquement)

Registre este producto en línea y reciba un ejemplar gratis de Cook's Illustrated. Visite www.prodregister.com/delonghi.

Visite www.delonghi.com para ver la lista de centros de servicios cercanos a usted. (Solamente en los Estados Unidos y Canada)

Registra questo prodotto "on-line" per ricevere una copia omaggio della rivista. Visita www.prodregister.com/delonghi.

Visita www.delonghi.com per una lista dei centri di servizio a te più vicini. (Solo negli Stati Uniti e Canada)

Instructions for use

Keep these instructions

Mode d'emploi

Conservez cette notice

Instrucciones para el uso

Repase y guarde estas instrucciones

Istruzioni per l'uso

Leggere e conservare queste istruzioni

ELECTRONIC CHARACTERISTICS: CARACTÉRISTIQUES ÉLECTRIQUES:
CARACTERISTICAS ELECTRICAS: CARATTERISTICHE ELETTRICHE:
120V~60Hz - 1400 W

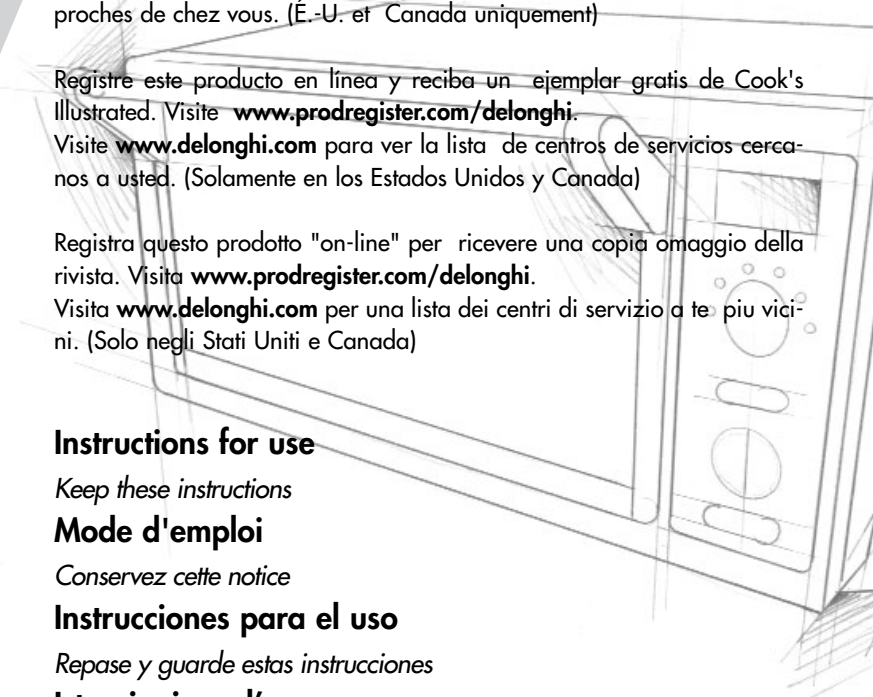

ELECTRICAL CONNECTION

Only use a three-pin, 120 Volt, 60 Hz power outlet

GROUNDING INSTRUCTIONS

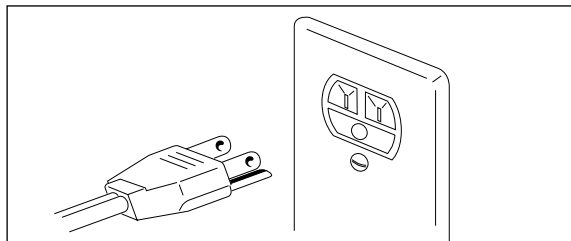

MAKE SURE THAT THE PLUG IS CORRECTLY GROUNDED

This appliance must be grounded: in the event of short circuits, the ground connection reduces the risk of electric shock, allowing the electrical current to be dispersed.

This appliance is fitted with a power cable with ground wire.

The plug must be connected to a power outlet that has been correctly installed and grounded.

WARNING: IMPROPER USE OF THE GROUND WIRE MAY LEAD TO THE RISK OF ELECTRIC SHOCK.

If you are not sure that the power outlet is properly grounded, contact a qualified electrician.

If an extension cord is required, only use three-wire extension cords with three-pin plugs and sockets that fit the plug on the appliance.

The capacity of the extension cord must be greater than or equal to the rated power input of the appliance.

- The length of the power cable for this appliance has been devised so as to avoid the possibility of tripping on or getting entangled in a long cable.
If a longer cable is required, an extension cord can be used with a rated capacity not below 15 amps, 120 volt and with UL/CSA approval.
- A six-foot long extension cord, with a 15 amp rating, is available from authorized resellers.
When using an extension cord, make sure it does not hang loose in the work area or where someone may accidentally trip on it or get entangled in it.
- Handle the power cable with care for longer life; avoid pulling or stressing the cable around the connectors to the power outlet and the appliance.

CONVERSION TABLE

°C	°F
95	200
107	225
120	250
135	275
150	300
163	325
177	350
190	375
205	400
218	425
233	450

CONTENTS

CHAP. 1	GENERAL	
1.1	Control panel	3
1.2	Description of the appliance	4
1.3	Important safeguards	5
1.4	Summary table	6
1.5	Correct wire rack position	7
1.6	Installation	7
1.7	Important tips and techniques	8
CHAP. 2	USING THE CONTROLS AND SETTING THE MODES	
2.1	Setting the clock	8
2.2	BAKE and FAN/BAKE modes	9
2.3	SMART COOKIES mode	13
2.4	DEHYDRATOR mode	14
2.5	PIZZA mode	15
2.6	DEFROST mode	17
2.7	BROIL mode	18
2.8	TOAST mode	19
2.9	KEEP WARM mode	20
CHAP. 3	CLEANING AND MAINTENANCE	
3.1	Care and cleaning	21

1.1 CONTROL PANEL

- 1 Display
- 2 TOAST pilot light
- 3 KEEP WARM pilot light
- 4 FAN & BAKE / DEFROST pilot light
- 5 BAKE pilot light
- 6 BROIL pilot light
- 7 PIZZA pilot light
- 8 DEHYD pilot light
- 9 SMART COOKIES pilot light
- 10 MODE knob
- 11 TEMP./SELECT/CLOCK button
- 12 TIME/TOAST COLOR knob
- 13 START/STOP button

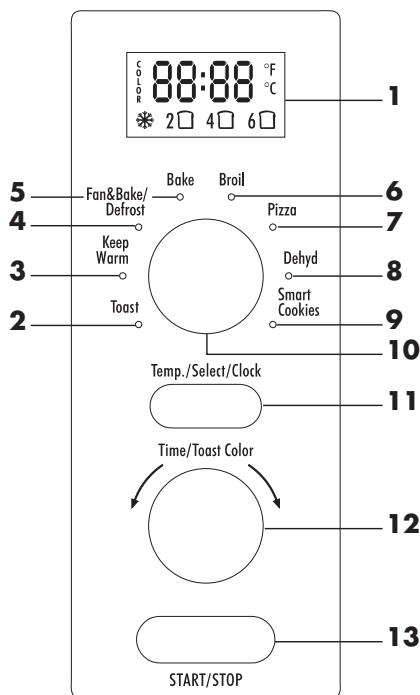

1.2 DESCRIPTION OF THE APPLIANCE

- | | |
|--|--------------------------|
| A Control panel | L Cookie sheets |
| B Glass door | M Broil rack |
| C Crumb tray | N Dehydrator rack |
| D Bottom heating element | O Pizza tray |
| E Top heating element | |
| F Interior light | |
| G 12" pizza-shaped wire rack | |
| H Bake pan | |
| I 12" pizza-shaped reversible wire rack | |

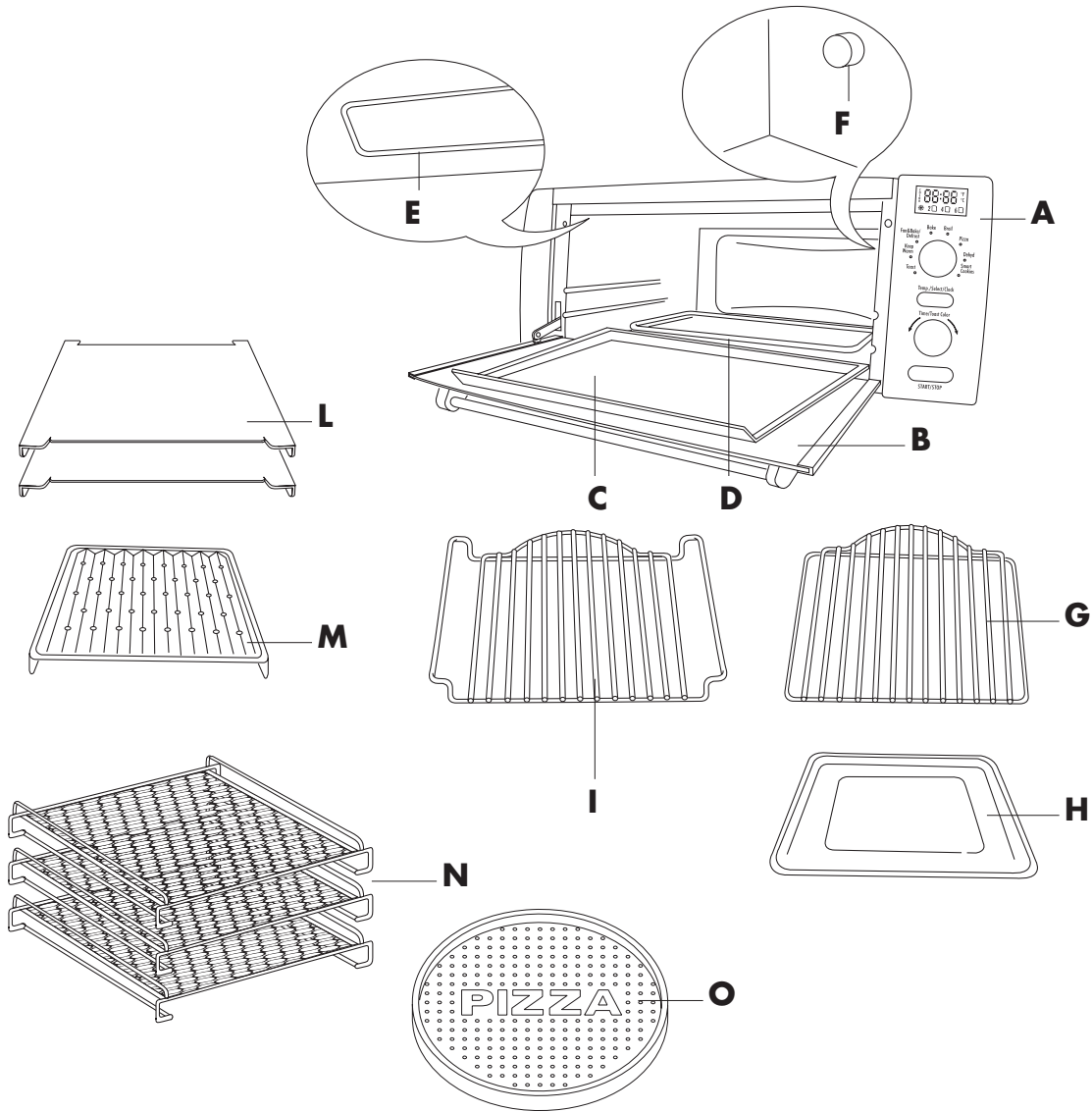

1.3 IMPORTANT SAFEGUARDS

When using electrical appliances, a number of fundamental safety rules must be observed, including the following:

1. READ ALL THE INSTRUCTIONS

- Do not touch the hot surfaces. Only use the knobs or handles to operate the appliance.
- Before using the appliance, move it 2 inches (5/10 cm) away from the wall and any other object that is on the same surface. Remove any objects located above the appliance. Do not use on surfaces that may be damaged by the heat.
- To avoid electric shock, do not immerse the appliance in water. See the instructions for cleaning.
- If the appliance is used when children are around, pay careful attention to the metal walls of the oven and the door, which become very hot.
The appliance must not be used by children without supervision.
Make sure that children do not play with the appliance.
- Unplug the appliance from the power outlet when this is not being used or before cleaning it.
Wait for the appliance to cool down before fitting or removing any parts.
- Never operate the appliance with the cable or the plug damaged, if any malfunctions have occurred, or if the appliance has been damaged in any way.
Take the appliance to the nearest authorized service center, which will inspect it and, if necessary, will adjust or repair it.
- The use of accessories that are not recommended by the manufacturer may cause injuries.
- Do not use outdoors.
- Do not let the power cable hang from the counter or come into contact with hot surfaces.
- Do not place the appliance above or near a gas or electric cooker.
- Use maximum care when moving the appliance if it contains hot oil or other hot liquids.
- If the plug heats up, contact a qualified electrician.
- Do not use this appliance for purposes other than those it has been designed for.
- Use maximum care when removing the bake pan or throwing out the hot fat.
- Do not use metal sponges to clean the appliance, small particles may be detached that cause electric shocks.
- To ensure the safe operation of the appliance, never introduce foods or utensils that are too large for the oven.
- If the appliance, when operating, is covered by or comes into contact with flammable materials, such as curtains, fabrics or wall coverings etc., these may catch fire.
- WARNING: Never leave the appliance unattended when operating (especially when broiling or toasting).**
- When broiling, the bake pan and the wire racks must be used as described in the instructions on page 18.
- Extreme care must be taken when using containers made from materials other than glass, metal or oven-proof ceramics.
- Do not place any objects in the oven when it is not being used, apart from the accessories recommended by the manufacturer.
- Do not place any of the following materials into or on top of the oven: paper, cardboard, plastic and the like.
- Do not cover parts of the oven with metal foil, to avoid overheating.
- To switch the appliance off, press START/STOP button.

This product is designed exclusively for household use



SAVE THESE INSTRUCTIONS



WARNING: After having removed the appliance from its packaging, check that the door is intact.

The door is made from glass and is therefore fragile. If it is visibly chipped, scored or scratched, it should be replaced.

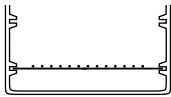
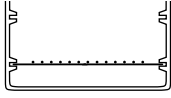
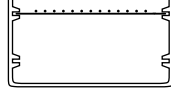
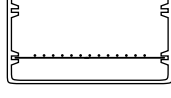
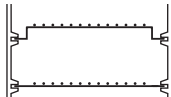
While using, cleaning or moving the appliance, avoid slamming or knocking the door. Do not pour cold liquid onto the glass while the appliance is hot.

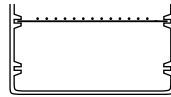
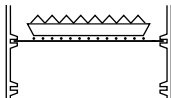
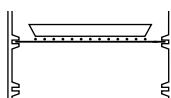
1.4 SUMMARY TABLE

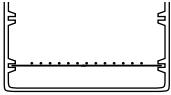
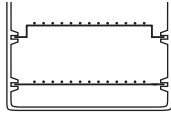
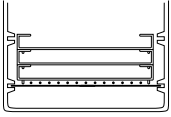
Program	Modes	Temperature setting/display indication	Wire rack and accessory position	Notes/Tips
Defrost	FAN & BAKE/DEFROST	DEFR 		-
Keep warm	KEEP WARM	180 °F		-
Convection oven cooking	FAN & BAKE/DEFROST	200 °F - 450 °F		Ideal for lasagna, meat, pizza, cakes in general, foods that should be crunchy on the surface ("au gratin") and bread. For details on how to use the accessories, refer to the tips in the table on page 12.
				
Traditional oven cooking	BAKE	200 °F - 450 °F		In addition, this function is ideal for cooking on two levels at the same time. For tips on how to do this, refer to page 10.
				
Toast	TOAST	COLOR 1-7 2 ☐ - 6 ☐ 		Ideal for toasting slices of bread.
Broiling and top browning	BROIL	BRL	 for broiling	Broil function is ideal for all types of traditional grilling: hamburgers, hot dogs, kebabs, etc. Use the top browning function to top brown open-face sandwiches, cheese toppings, and hors d'oeuvres.
			 for top browning	

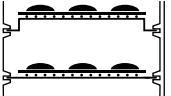
Program	Modes	Temperature setting/display indication	Wire rack and accessory position	Notes/Tips
Pizza	PIZZA	P1 - P3 1 level ❄		Please read the instruction on page 15.
		2P1 - 2P3 2 level ❄		
Dehydrator	DEHYD	DEH		Place prepared food on the dehydrator kit without covering shelves with plastic food wrap. The fan and low heat will dry food in 8 to 14 hours. Consult a book on drying foods for treatment of various foods.
Smart cookies	SMART COOKIES	1TR	 1 level	This function is ideal for cookies. For further information please refer to the paragraph on page 13.
		2TR	 2 level	

1.5 CORRECT WIRE RACK POSITION

For single cooking:



(1)

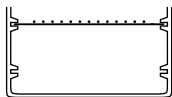

(2)

For double cooking:

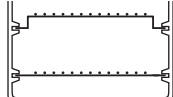

(3)

1.6 INSTALLATION

- 1) Check that the appliance has not suffered any damage due to transportation.
- 2) Place the appliance on a flat, stable surface out of the reach of children (the glass door becomes very hot while the oven is in operation).
- 3) Before using this appliance, move it two inches away from the wall or any object on the counter top. **Remove any object that may have been placed on top of the appliance.** Do not use on surfaces where heat may be a problem.
- 4) Initial start-up operation may result in minimal smell and smoke (about 15 min.). This is normal. It is due to the protective substance on heating elements which protects them from salt effects during shipping from the factory.
- 5) When a function is started, the START/STOP button will light.
- 6) If **ERR** message is shown on display, the oven has been damaged. Please contact an authorized service center.

1.7 IMPORTANT TIPS AND TECHNIQUES

ACCESSORIES AND UTENSILS

The bake pan (H) is designed to permit the circulating heat to surround the food (except for the bottom surface) more effectively. Use it as you would any shallow baking or roasting pan. Other utensils you own can be used provided that an inch or so of space remains open to allow circulation of the fan-forced heat. Casserole covers should not be used and glass ovenware should not be placed closer than two inches from the upper heating element.

The cookie sheets (L) provided **must** also be centered on the rack. When using both sheets on two wire racks, place the reversible wire rack in the upper guide.

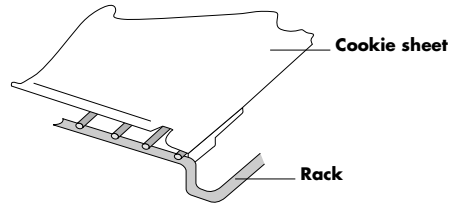

PREHEATING THE OVEN

To pre-heat the oven, press the required function (BAKE, FAN & BAKE) and set the desired temperature (only for BAKE and FAN & BAKE). After having pressed START/STOP, if no duration has been set, the display will show the countdown starting from the default duration of 30 minutes. On reaching the set temperature, the control will emit 3 "beeps" 3 times.

USING ALUMINUM FOIL

Do NOT allow foil to touch sides of the oven or the heating elements. Foil can be used to cover foods or the shallow pan (for easier clean-up) provided foil is tucked in securely around the food or the edges of the pan or dish. DO NOT cover the broiling rack as this can cause accumulated grease to catch fire. DO NOT cover the crumb tray (C).

Unlike an ordinary toaster-oven, the DE'LONGHI features 8 functions: convection/defrost, traditional bake, keep warm, broil, toast, dehydrate, smart cookie and pizza functions.

2.1 SETTING THE CLOCK

- When the appliance is connected to the power supply for the first time, or after a power outage, four dashes will appear on the display (----). In order to set the time of day, proceed as described below:

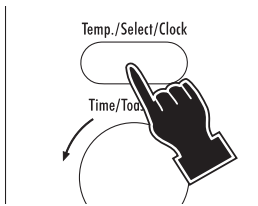

- 1 Press the TEMP./SELECT/CLOCK button (11). (the hours flash on display)

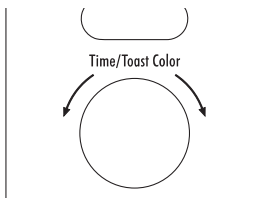
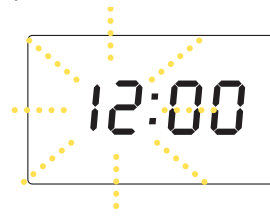

- 2 Turn the TIME/TOAST COLOR knob (12) to the desired time. The times set will begin blinking on the display.

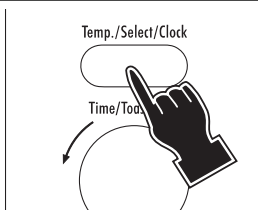

- 3 Press the TEMP./SELECT/CLOCK button (11) the minutes begin to flash on the display.

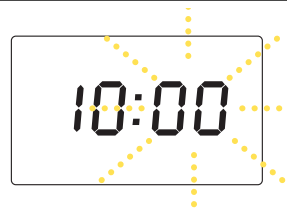

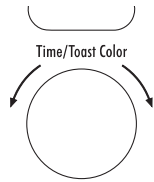

4 Turn the TIME/TOAST COLOR knob (12) to the desired time. The time set will begin blinking on the display.

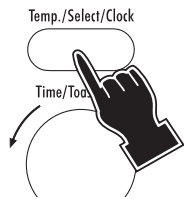

5 Press the TEMP./SELECT/CLOCK button (11) at any time during cooking process to display the current time. (the display shows the time set)



- If you wish to change the hour on the dial once it has been set, press the TEMP./SELECT/CLOCK button (11) before proceeding to set the new time as described above.
- It is possible to display the current time even after starting a function, by pressing the TEMP./SELECT/CLOCK button (11) (the time is displayed for 2 seconds).

2.2 BAKE AND FAN/BAKE MODES

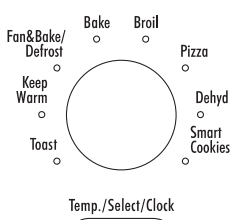

1 Turn the MODE knob (10) to the desired function. BAKE (5) or FAN & BAKE/DEFROST (4). The display will show the default temperature (**350°F**)

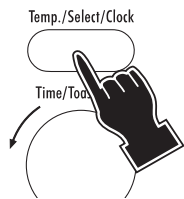
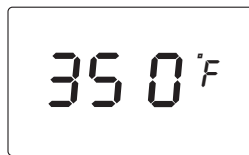

2 If necessary, the desired temperature can be modified by pressing the TEMP./SELECT/CLOCK button (11). The available temperatures are: 200 - 250 - 275 - 300 - 325 - 350 - 375 - 400 - 425 - 450°F. The display will show the chosen temperature.

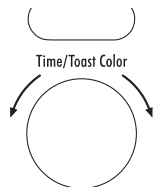

3 Set the time (max 2 hours) by turning the TIME/TOAST COLOR knob (12).

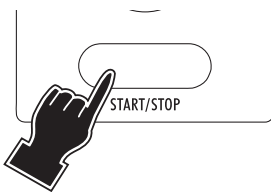
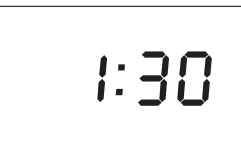

4 Press the START/STOP button (13). The oven will start the countdown. At the end of the set time the control will emit 3 "beeps" and the display will return to stand-by (showing the time of the day, if previously set).

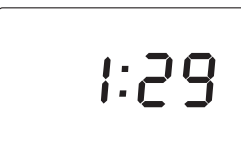

Notes:

- If the cooking time is not set (skipping point 3), the display will show the countdown starting from the default duration of 30 minutes.
- The oven should always be preheated. Wait for the audible signal (3 times 3 short beeps) before placing the tray with food in the oven.
- The set time can be modified during cooking by simply repeating point 3. The countdown will automatically restart 3 seconds after the last setting.
- To display the current temperature inside the oven during the cooking process, simply press the TEMP./SELECT/CLOCK button (11). While the temperature is displayed, you have 3 seconds to press the TEMP./SELECT/CLOCK button (11) again to modify the set temperature.
- If the START/STOP button (13) is not pressed within 3 minutes from the previous setting, the control will return to stand-by.

Cooking on 2 levels at the same time with the convection oven

The convection oven function allows different foods to be cooked at the same time, placed on 2 levels.

The heat provided by the 2 heating elements, is distributed inside the oven by the air, circulated by the fan.

In this way, the heat reaches every part of the oven **uniformly and quickly**; the air inside the oven is very dry, preventing the mixing of flavors.

To cook two dishes at the same time, simply observe these general rules.

1. The cooking times for different recipes prepared simultaneously are higher than when the items are cooked individually.
2. Around halfway through cooking, **change the position** of the 2 bake pans, placing the top one on the lower wire rack and vice-versa.

In addition, **turn** the bake pans **half-way** around.

Note: the wire racks must be positioned as shown in the figure to the side.

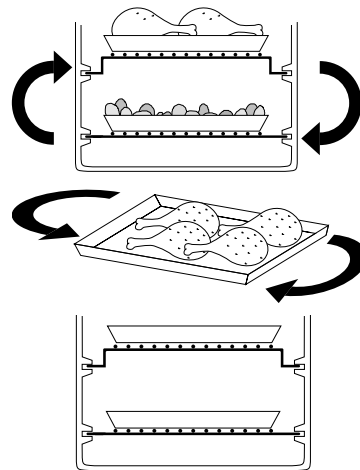
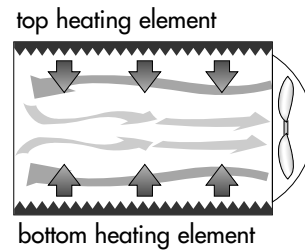

GENERAL GUIDELINES

With **FAN & BAKE / DEFROST** mode, a fan gently circulates the heated air within the oven, providing a more even temperature around the food. This system, used in many large commercial ovens for years, produces more even browning and cooking of baked foods, meats and poultry. The forced air also displaces the layer of cold air surrounding the food, allowing faster cooking in many cases or a lowering of temperature. In general, meats and poultry can be cooked in less time (a meat thermometer will help to prevent overcooking). Cakes, pies, cookies, etc. can be baked at a lower temperature (see charts).

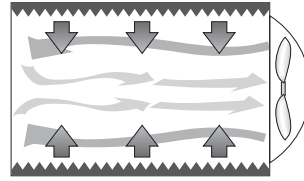

BAKE mode is used when browning and crisping are less important or undesirable. Use it, following conventional recipes, for casseroles, stuffed vegetables, fish, lasagna, fruit tarts, cheesecakes and other moist mixtures.

IMPORTANT

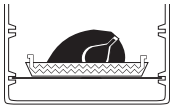

We recommend cooking chicken, roasts and small fowl directly on the broiling rack resting on the baking pan (see fig. on the left) to avoid fat spattering onto the sides of the oven and dripping onto the bottom. See the following sections for further details.

CONVECTION BAKING OF CONVENIENCE FOODS

Many convenience foods can be successfully baked or heated by convection on the **FAN & BAKE / DEFROST** mode. In general, follow the package directions for temperature and time. **However, lower the temperature by 25°F.** There is such a wide choice of convenience foods on the market and variations in packaging, quantities and initial temperatures (frozen, refrigerated and shelf temperature) that it's best to follow the package instructions. Check the food 5 to 10 minutes before the time is up; you may need to adjust the time and/or temperature for best results.

Here are some tips for different types of convenience foods:

- If directions call for placing the food container on a metal pan or cookie sheet to avoid spills or to aid even cooking, use the bake pan provided. Use it or the cookie sheets provided for foods, such as rolls, cookies, turnovers or frozen French fries, breaded fish or chicken pieces, that are placed directly on a pan or cookie sheet.
- Some frozen foods come in "oven-proof" plastic or paper containers which can be cooked in a microwave oven and, within limits, a conventional oven. Be sure to follow directions for maximum baking temperature. The container can melt or scorch if too high a temperature is used. To be on the safe side, set the oven 25°F lower than the recommended temperature.
- When baking packaged mixtures (such as scalloped potatoes, macaroni and cheese, brownies, corn bread, coffeecake and cake mixes) check the package directions for recommended sizes of pan, casserole or dish and the proper baking times for each. A 9-inch round or an 11 x 7 inch rectangular pan will fit in the oven with room on all sides for air circulation.
Layer cake mixes can be baked one layer at a time in a 8- or 9-inch round pan or all of the batter in a 3-inch deep 9-inch round bundt or spring-form pan.

TEMPERATURE AND TIME FOR TYPICAL FOODS (convection baking and roasting)

FOOD	MODES	TEMPERATURE SETTING/DISPLAY INDICATOR	APPROX. TIME	NOTES AND TIPS
Whole chicken 3-3.5 lbs. Unstuffed.	FAN & BAKE / DEFROST	350°F	75 min. or until internal temperature of 175°F in thigh and breast.	Roast in bake pan with broiling rack inverted, with rack in position 1 (see pag. 7).
Pork Loin or Rib Roast, 2 - 4 lbs.	FAN & BAKE / DEFROST	325°F	90 min. or until internal temperature of 170°F is reached.	Roast the same as the whole chicken. Broiling rack may be in its higher position if oven space allows.
Pork Baby Back Ribs 1.75 - 2 lbs. in 6 - to 10 - inch strips.	FAN & BAKE / DEFROST	300°F for 20 min. then BROIL for 30 min.	Total time 50 min. or until brown and very tender.	Use pan without rack, lined with foil, on rack position 1.
Beef Sirloin or Rib Roast 3 - 5 lbs, boned.	FAN & BAKE / DEFROST	350°F	20 min./lb. for rare 25 min./lb for medium 30 min./lb. well	Have roast tied for even cooking. Use broiling rack in position 1 or 2 as oven space allows (see pag.6).
Cornish Hens 1.5 lbs. each, two split into four halves.	FAN & BAKE / DEFROST	350°F	45 - 50 min. or until tender and juice is clear when pierced with fork.	Roast on pan with broiling rack in position 2, skin side up. Brush with orange marmalade or honey. Turn and brush several times until done.
Baking Potatoes 1 to 4 large.	BAKE	450°F	45 - 50 min. or until fork-tender.	Wash and pierce raw potatoes with fork. Rub skins with salad oil if desired. Bake on wire rack in position 1.
Cakes: Layer, Sheet cake or Loaf cake. Pies: Fruit, 9- inch double crust.	FAN & BAKE / DEFROST	300°F to 350°F	Cake: Follow traditional recipe timing but lower temperature by 25 to 50°F.	Cake: Place wire rack in position 1. Check progress 5 - 10 min. before time is up. Let cool 5 - 10 min. to firm up before removing from pan or dish.
			Cookie: After the preheating signal. 20-30 minutes, depending on the type of cookie.	
Brownies, Bar, Cookies.	FAN & BAKE / DEFROST	300°F to 325°F	Cake: Follow traditional recipe timing but lower temperature by 25 to 50°F. Use 7x11 inch or 8- or 9 inch square pan or oven-glass dish.	Cookie: Place 1 inch apart on 1 or 2 cookie sheets. For 1 sheet place wire rack in position 1. For 2 cookie sheets, place racks in position 3 (see pag.6). Grease sheets if the recipe directs. Remove promptly to cooling rack.
			Cookie: After the preheating signal. 20-30 minutes, depending on the type of cookie.	

2.3 SMART COOKIES MODE

This special function is designed to produce perfect results when using one or two trays to bake delicate food items such as cookies, brownies, cakes, pies etc. The function is accessible by turning the MODE knob (10) until the SMART COOKIES indicator is illuminated and **TRT** is on the display. Please note, this function is programmed to control temperature, so only the baking time can be adjusted. Follow the full set of instructions as outlined below. The oven should always be pre-heated.

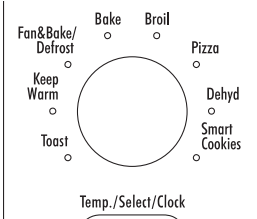

- 1 Turn the MODE knob (10) until the SMART COOKIES light is illuminated and **TRT** is on the display.

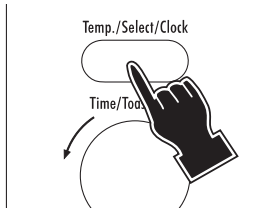
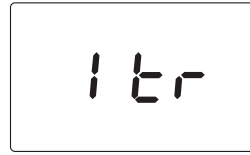

- 2 Press the **TEMP./SELECT/CLOCK** button (11) to select 1 or 2 cooking levels.

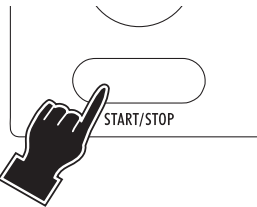
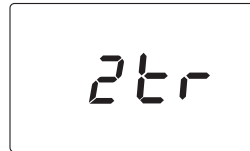

- 3 Press the **START/STOP** button (13). The oven starts the pre-heating phase.

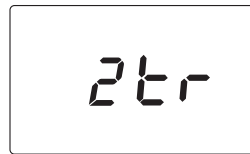

- When the oven reaches the ideal baking temperature, an audible signal will sound (three series of short beeps) and the baking time will start flashing.
- Place the cookies in the oven and press **START/STOP**; the oven will start the countdown.
- If during the cooking process you wish to increase or decrease within 5 minutes the set time, turn the **TIME/TOAST COLOR** knob (12).

Only when baking on two levels: at 3/4 of the baking time, an audible signal will sound to indicate that the cookie sheets (L) need to be swapped and turned 180 degrees (see the figure on the right).

Once the two sheets have been swapped, press **START/STOP** to stop the baking process.

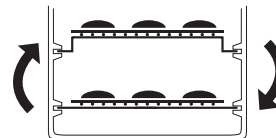

If **START/STOP** is not pressed within 3 minutes from when the “beeps” sound, the function will resume automatically, ending the baking after the set time.

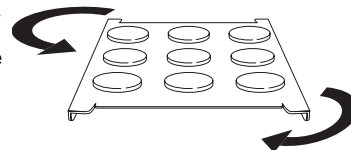

2.4 DEHYDRATING MODE

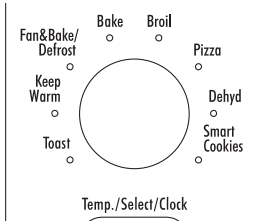

- 1 Turn the MODE knob (10) until the DEHYD light is illuminated and *DEH* is on the display.

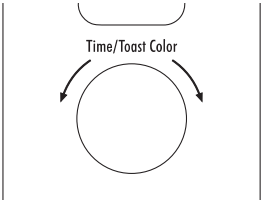

- 2 Set the time (max 14 hours) by turning the TIME/TOAST COLOR (12) knob.

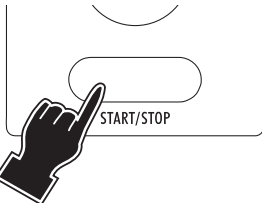

- 3 Press the START/STOP button (13). The oven will start the countdown. At the end of the set time the control will emit 3 "beeps" and the display will return to stand-by (showing the time of the day, if previously set).



Slices of apples, pineapple, pears, peaches or bananas, placed directly on the dehydrator kit, will dry in 8 to 14 hours in the gently circulating warm air. Time will depend on the moisture in the fruit. Herbs can also be dried. However, the limited quantity of vegetables that can be dried at one time may not be worth your time and attention. Consult a book on dehydrating food for specific directions as to times, temperature, pre-treatment and storage of dried foods.

FOR DEHYDRATING:

- Prepare food and use the dehydrating kit as follows:
- insert wire rack (G) in the slot 1;
- put the dehydrator kit on the wire rack (see figure).

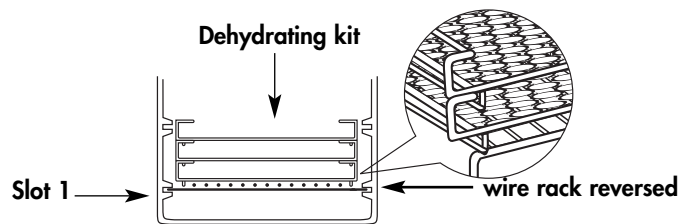

2.5 PIZZA MODE

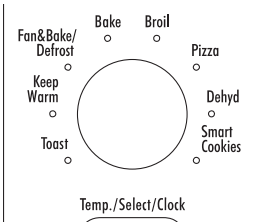

- 1 Turn the MODE knob (10) until the display shows ***P1** and the relevant led lights on.

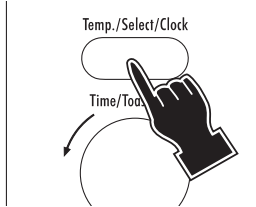

- 2 Select the desired program (see table on the following page) by pressing repeatedly the TEMP./SELECT/CLOCK button (11); place the pizza in the oven.

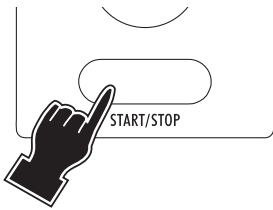

- 3 Press the START/STOP button (13); the display will show the countdown. At the end of the set time the control will emit 3 "beeps" and the display will show the time of the day, if previously set.

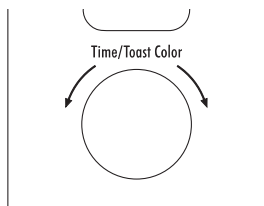

- 4 If during the cooking process you wish to increase or decrease within 5 minutes the set time, turn the TIME/TOAST COLOR knob (12). This operation can be done only once the START/STOP button (13) has been pressed.

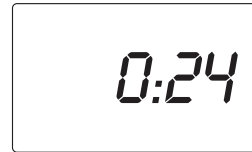

- If the START/STOP button (13) is not pressed within 3 minutes from the previous setting, the control will return to stand-by.
- The cooking process can be stopped at any moment by pressing the START/STOP button (13).

NOTES/TIPS TO COOK PIZZA

- If the oven is already hot (e.g. in case of sequential pizza cooking), the electronic control will automatically reduce/adjust the cooking time.
- Always put the pizza on the pizza tray on the wire rack (G) provided; then insert the tray in position 1 (see pag.6).
- Frozen pizza: remove the pizza from its packaging and put the pizza directly on the pizza tray (O).
Home - made pizza with fresh dough: prepare the pizza on the well greased pizza tray (O) or line the tray with oven-proof paper. We suggest adding mozzarella or soft cheese just five minutes before the end of cooking process: the cheese will melt perfectly without overburning.
- In order to select the right program, refer to the following table.
- Cooking result may vary; adjust these settings to your individual preferences.

DISPLAY INDICATION	NOTES/TIPS
* P1	Ideal for small frozen pizzas (weight 6.5 - 9 ounce)
* P2	Ideal for medium frozen pizzas (weight 9 - 18 ounce)
* P3	Ideal for big frozen pizzas (weight 18 - 28 ounce)
P1	Ideal for one fresh pizza
2P1	Ideal for two fresh pizzas
* 2P1	Ideal for 2 small frozen pizzas (weight 6.5 - 9 ounce)
* 2P2	Ideal for 2 medium frozen pizzas (weight 9 - 18 ounce)
* 2P3	Ideal for 2 big frozen pizzas (weight 18 - 28 ounce)

Correct wire rack/pizza tray position

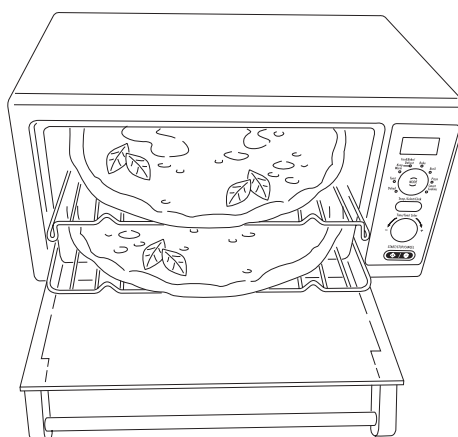
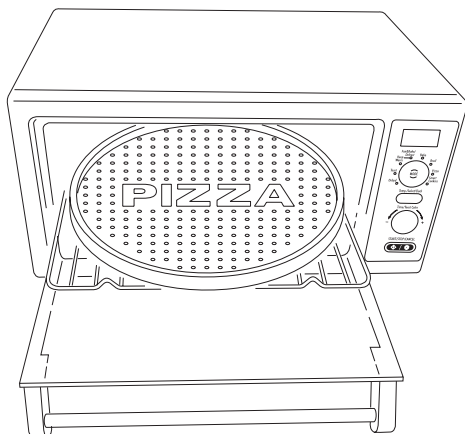

Single cooking

Double cooking

At 2/3 of the cooking time, an audible signal will sound to indicate that the two pizzas need to be swapped over, placing the top one on the bottom rack and vice-versa. Also turn them around 180 degrees. Then press START/STOP to start the cooking process. If START/STOP is not pressed within 3 minutes from when the "beeps" sound, the function will resume automatically.

2.6 DEFROSTING MODE

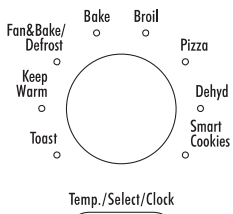

- 1 Turn the MODE knob (10) until the FAN BAKE/DEFROST led lights on.

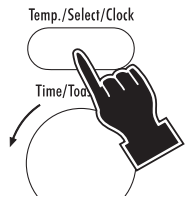

- 2 Then press the TEMP./SELECT/CLOCK (11) until the display shows **DEFr** 

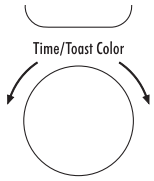

- 3 Set the time (max 2 hours) by turning the TIME/TOAST COLOR (12) knob.

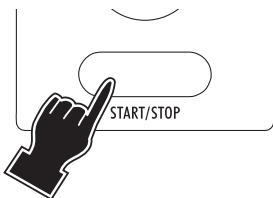

- 4 Press the START/STOP button (13). The oven will start the countdown. At the end of the set time the control will emit 3 "beeps" and the display will return to stand-by (showing the time of the day, if previously set).

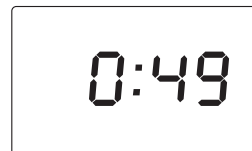

Notes:

- If the defrosting time is not set (skipping point 3), the display will show the countdown starting from the default duration of 30 minutes.
- If the START/STOP button (13) is not pressed within 3 minutes from the previous setting, the control will return to stand-by.

Portions and pieces of raw meat, poultry and fish, frozen soups, pastry, fruit or leftovers will thaw more quickly on this setting than on a counter or in the refrigerator.

Thaw only pieces or portions small enough to thaw in an hour or less and do not let food come to room temperature.

Thawed food held too long or at a warm temperature can cause bacteria to form.

Large amounts of food should be defrosted in a refrigerator.

2.7 BROILING MODE

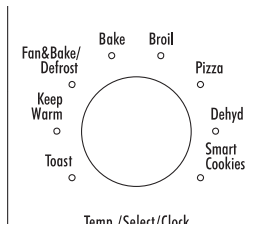

- 1 Turn the MODE knob (10) until the BROIL led lights on. The display will show the message **BRL**.

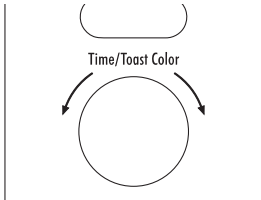

- 2 Set the time (max 1 hour) by turning the TIME/TOAST COLOR (12) knob.

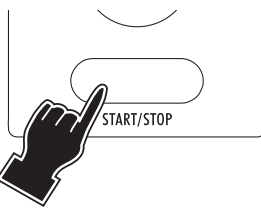

- 3 Press the START/STOP button (13). The oven will start the countdown. At the end of the set time the control will emit 3 "beeps" and the display will return to stand-by (showing the time of the day, if previously set).

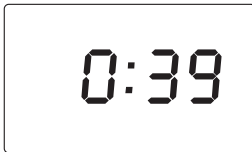

Notes:

- If the cooking time is not set, the display will show the countdown starting from the default duration of 15 minutes.
 - If the START/STOP button (13) is not pressed within 3 minutes from the previous setting, the control will return to stand-by.
 - Trim excess fat from meat. Dry meat, fish and poultry surfaces with paper towel.
 - Place the food on the broiling rack set in the shallow pan as shown in the figure. Position wire rack so that food will be about 2 inches from top heating element. Thick foods such as chicken pieces should be 3 - 4 inches from the element.
 - The broiling rack can be inverted if necessary, but do not attempt to broil without the rack as fat drippings can smoke or flame.
 - For easier clean-up, the shallow pan can be lined with foil. Be sure not to cover the broiling rack or let foil extend beyond the edges of the pan.
 - Be careful when turning food or removing the pan. Use potholders and avoid spilling drippings.
 - **Never cover heating elements with foil.**
 - To top-brown casseroles with crumb or cheese toppings, place the dish directly on the wire rack 2 - 3 inches from the top element. Close the door and watch carefully to avoid burning the toppings.
- NOTE: Oven-glass dishes should not be exposed to direct broiler heat.

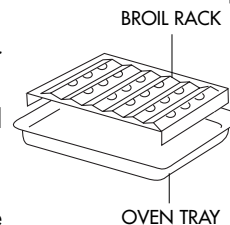

When the function and the temperature controls are set to BROIL only the top element heats at full power. Set the broiling rack in the bake pan on the wire rack in position 2 (see pag. 6) so that the food is few inches from the top element. For thick foods such as chicken parts place the rack in position 1. If necessary, the broiling rack can be inverted in the pan. The broiling rack shields the fat drippings from direct heat, reducing spattering, smoking and possible flaming. Always use the shallow pan when broiling any fatty foods.

SUGGESTED BROILING TIMES

FOOD	WEIGHT OR THICKNESS	APPROX. TIME (Turn at half time)
Beef Sirloin, Porterhouse Steak	1 - 1 1/2 in.	Rare 12 - 15 min. Medium 16 - 18 min.
Beef Flank Steak, Fillet	3/4 - 1 in.	Rare 10 - 12 min. Medium 13 - 16 min.
Hamburger	1 in.	Medium-well 15 - 18 min.
Pork Chop	3/4 in.	Well 18 - 22 min.
Fish Fillets, Steak (See note)	1/2 - 1 in.	10 - 16 min.
Chicken Piece, Broiler-fryer	3 - 4 lb.	40 - 50 min. until juices run clear when fork-tested and no pink when cut.
Bacon, Sausage, Links or Patties	Up to capacity of broil-rack.	10 - 15 min. for crisp bacon, well-done sausage.

Note: Since fish is non-fatty it can be broiled directly on bake pan. Broil until it flakes easily with a fork. Thin fillets need not to be turned.

2.8 TOASTING MODE

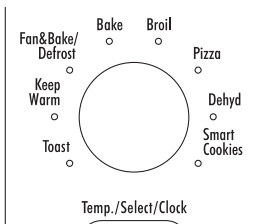

- 1 Turn the MODE knob (10) until the TOAST led lights on.

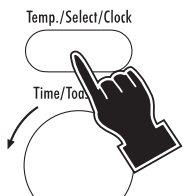

- 2 Press TEMP./SELECT/CLOCK buttons (11) to modify the number of slices.

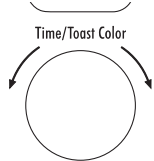
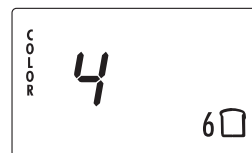

- 3 Set the desired level of toasting by turning the TIME/TOAST COLOR (12) knob.



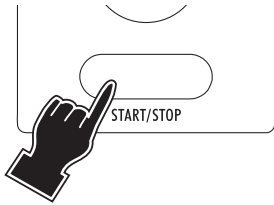

- Press the START/STOP (13) button. The display will show the toasting time. At the end of the set time the control will emit 3 "beeps" and the display will return to stand-by (showing the time of the day, if previously set).



Note:

- You have seven browning selection shades to choose from (indicated on the display with "COLOR 1-2-3-4-5-6-7")
- It is possible to select the number of slices to toast (2-4-6) and the start condition; if the slices are fresh, please select the number without (*), if the slices are frozen, before choosing the number, please select (*).
- When toasting, the toasting time will count down on the clock display. The timing will be different for each custom setting you choose. Keep in mind that the timing is adjusted by the oven thermostat. So if your oven is already warm, the toasting time will be less than if you start with a cold oven.
- Should it be necessary for any reason to suspend the cooking, you only need to press the START/STOP (13). The display will go back to showing the clock.
- If the START/STOP (13) button is not pressed within 3 minutes from the previous setting, the control will return to stand-by.
- Correct position of the slices according to number.

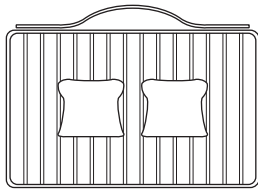

2 slices

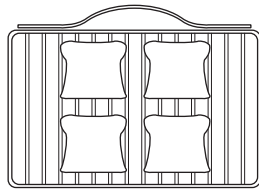

4 slices

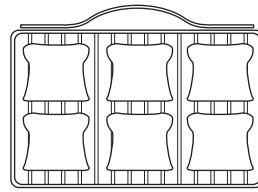

6 slices

2.9 KEEP WARM MODE

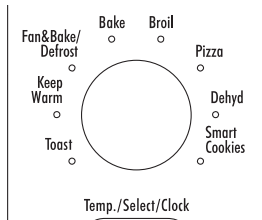

- Turn the MODE knob (10) until the KEEP WARM indicator light is illuminated and **180°F** is displayed.

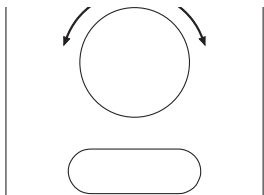

- Select the keep warm time by turning the TIME/TOAST COLOR knob (12).

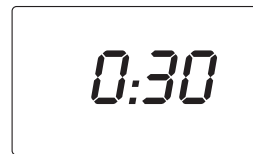

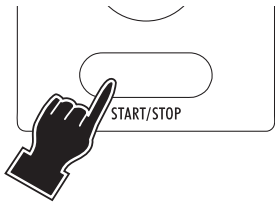

- 3 Press the START/STOP (13) button. The oven will start the countdown. At the end of the set time the control will emit 3 beeps and the display will return to stand-by (showing the time of the day, if previously set).



Notes:

- If the keep warm time is not set (skipping point 2), the display will show the countdown starting from the default duration of 30 minutes.
- If the START/STOP (13) button is not pressed within 3 minutes from the previous setting, the control will return to stand-by.

3.1 CARE AND CLEANING

Frequent cleaning prevents the formation of smoke and bad odors during cooking. Do not let fat accumulate inside the appliance.

Before any maintenance or cleaning operation, unplug the oven and wait for it to cool down.

Clean the door, the inside walls and the enamel or painted surfaces of the oven with a soap and water solution; dry thoroughly.

To clean the aluminum surfaces on the inside of the oven, never use products that corrode aluminum (detergents in spray cans) and never scrape the walls with sharp objects.

To clean the outside surface always use a damp sponge.

Avoid using abrasive products that may damage the exterior.

Make sure water or liquid soap does not seep into the vents on the top of the oven.

Never immerse the appliance in water; never wash it under a jet of water.

All the accessories are washed like normal dishes, either by hand or in the dishwasher.

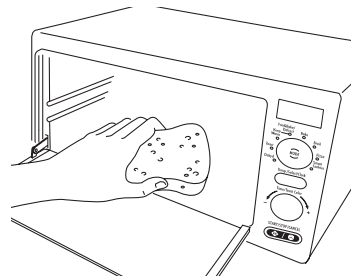
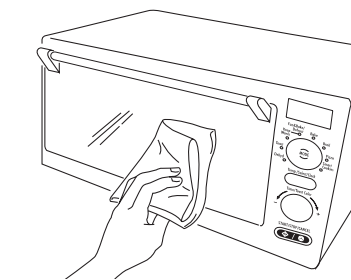

Crumb tray

Slide the crumb tray out from under the bottom of your oven. Wash by hand. Should the soilage be difficult to remove, rinse the crumb tray with hot soapy water and if necessary, scour it delicately, without scratching it.

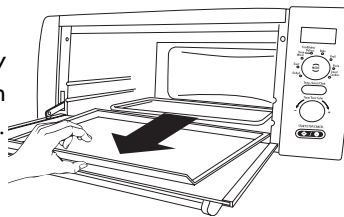

Interior light

When the oven is on, the light inside the oven is always on.

To replace the bulb, proceed as follows: unplug the appliance from the power outlet, unscrew the glass cover and replace the bulb with a new one of the same type (resistant to high temperatures) and then replace the glass cover.

LIMITED WARRANTY

This warranty applies to all products with De'Longhi or Kenwood brand names.

What does the warranty cover?

We warrant each appliance to be free from defects in material and workmanship. Our obligation under this warranty is limited to repair at our factory or authorized service center of any defective parts or part thereof, other than parts damaged in transit. In the event of a products replacement or return, the unit must be returned transportation prepaid. The repaired or new model will be returned at the company expense.

This warranty shall apply only if the appliance is used in accordance with the factory directions, which accompany it, and on an Alternating current (AC) circuit.

How long does the coverage last?

This warranty runs for one year (1) from the purchase date found on your receipt and applies only to the original purchaser for use.

What is not covered by the warranty?

The warranty does not cover defects or damage of the appliance, which result from repairs or alterations to the appliance outside our factory or authorized service centers, nor shall it apply to any appliance, which has been subject to abuse, misuse, negligence or accidents. Also, consequential and incidental damage resulting from the use of this product or arising out of any breach of contract or breach of this warranty are not recoverable under this warranty. Some states do not allow the exclusion or limitation of incidental or consequential damage, so the above limitation may not apply to you.

How do you get service?

If repairs become necessary, see contact information below:

U.S. Residents:

Please contact our toll free hotline at 1-800-322-3848 or log onto our website at www.delonghi.com.

For all accessories, spare parts or replacement parts, please contact our parts division at 1-800-865-6330.

Residents of Canada: Please contact our toll free hotline at 1-888-335-6644 or log onto our website at www.delonghi.com.

Residents of Mexico: Please refer to the Limited Warranty statement for Mexico.

Please refer to the back page of the manual for De'Longhi addresses.

The above warranty is in lieu of all other express warranties and representations. All implied warranties are limited to the applicable warranty period set forth above. This limitation does not apply if you enter into an extended warranty with De'Longhi. Some states do not allow limitations on how long an implied warranty lasts, so the above exclusions may not apply to you. De'Longhi does not authorize any other person or company to assume for it any liability in connection with the sale or use of its appliance.

How does state law apply?

This warranty gives you specific legal rights, and you may also have other rights, which vary from state to state.