

This Owner's Manual is provided and hosted by [Appliance Factory Parts](#).

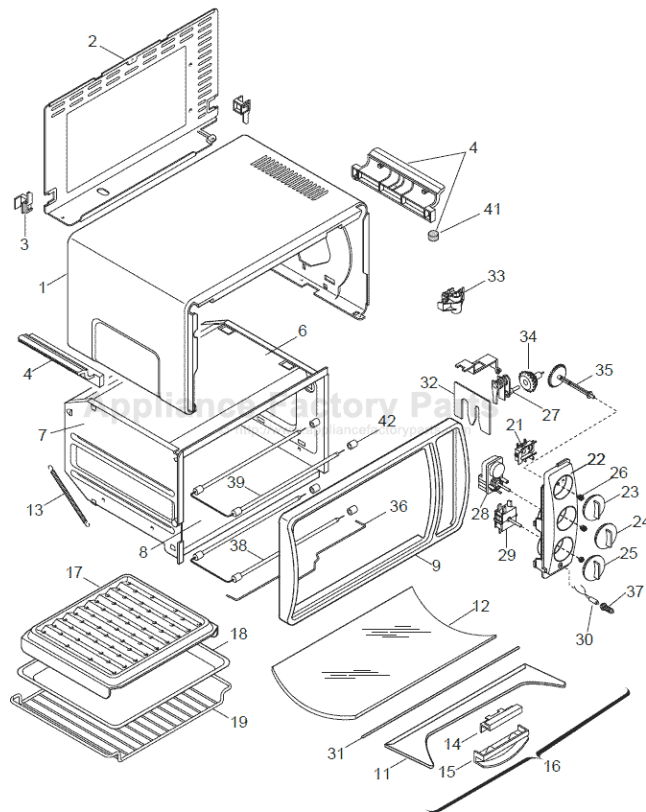

DE'LONGHI UX620 Owner's Manual

[Shop genuine replacement parts for DE'LONGHI UX620](#)



[Find Your DE'LONGHI Oven Parts - Select From 110 Models](#)

----- Manual continues below -----

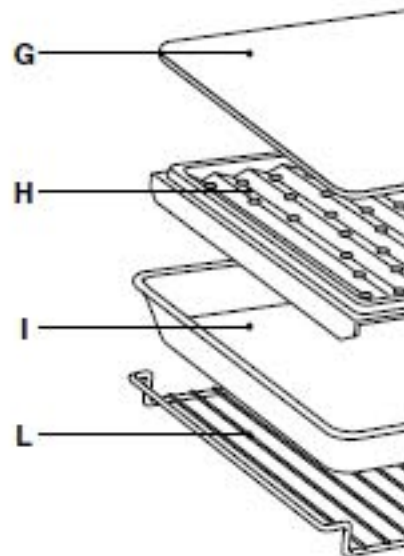
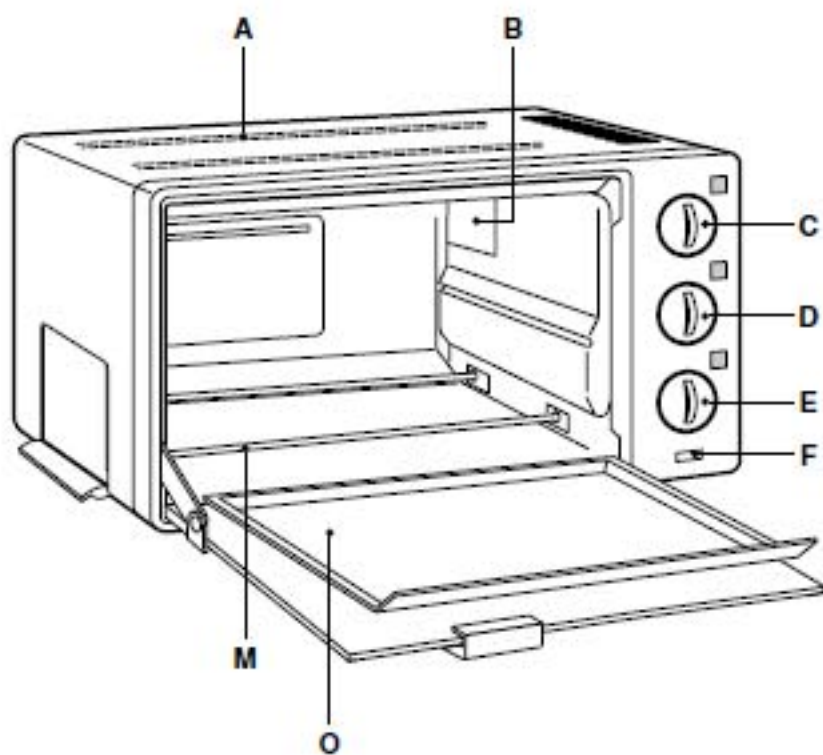

DESCRIPTION

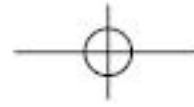

IMPORTANT SAFEGUARDS

When using electrical appliances, basic safety precautions should be followed, including the following:

1. **READ ALL INSTRUCTIONS.**
2. Do not touch hot surfaces. Use handles or dials.
3. Before using this appliance, move it two to four inches away from the wall or any object on top of the appliance. Do not use on surfaces that may cause a fire problem.
4. To protect against electrical shock, do not place unit in or under water. See instructions for cleaning.
5. Close supervision is necessary when any appliance is used by or near children.
6. Unplug from outlet when not in use and before cleaning. Always turn the ON/OFF dial to "OFF" before unplugging.
7. Do not operate any appliance with a damaged cord or plug or after the appliance malfunctions in any manner. Return appliance to the nearest authorized service facility for examination, repair or replacement.
8. The use of accessory attachments not recommended by the appliance manufacturer may cause fire or electric shock.
9. Do not use outdoors.
10. Do not let cord hang over edge of table or counter, or touch hot surfaces.
11. Do not place on or near a hot gas or electric burner.
12. Extreme caution must be used when moving an appliance containing hot oil or other hot liquids.
13. If the plug gets hot, please call a qualified electrician.
14. Do not use this appliance for other than intended use.
15. Use extreme caution when removing the oven pan or disposing of hot grease.
16. Do not clean with metal scouring pads. Pieces can break off the pad and touch electrical parts, causing electric shock.
17. To assure safe operation, oversized foods or utensils must not be inserted into the oven.
18. A fire may occur if this appliance is covered or touching flammable material, including curtains, when in operation.
19. **CAUTION:** Never leave the toaster-oven-broiler unattended when in use (especially when broiling).
20. When broiling, the oven-pan, the broiling rack and wire rack must be used according to the instructions.
21. Extreme caution should be exercised when using containers other than oven proof metal glass.
22. Do not store any materials, other than the manufacturer's recommended accessories, in the oven.
23. Do not place any of the following materials in the oven: paper, cardboard, plastic and the like.
24. Do not cover any part of the oven with metal foil. This will cause overheating of the oven.
25. To switch off the toaster-oven broiler, turn the ON/OFF dial to "OFF" and the temperature dial to "●".



THIS PRODUCT IS FOR HOUSEHOLD USE ONLY
SAVE THESE INSTRUCTIONS

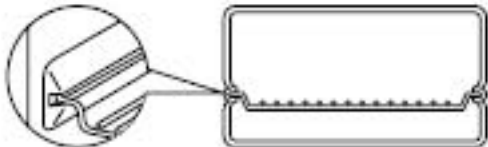
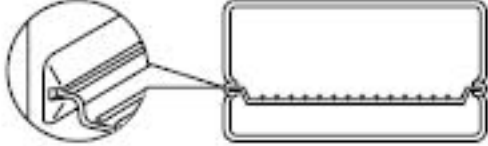
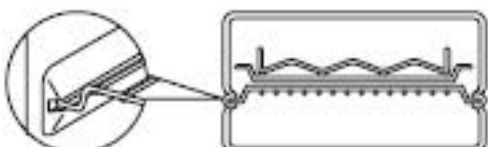
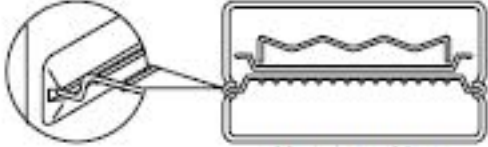
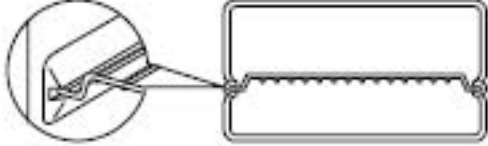
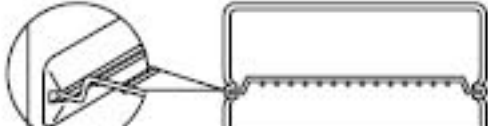

SUMMARY OF OPERATION

Program	Position ON/OFF and toast programming dial	Position of thermostat dial	Position of function selector dial	Position of wire rack/accessories	
Keep warm	ON	KEEP WARM	BAKE/TOAST		Turn warm an h hot temp
Bake	ON	UP TO 470 °F	BAKE/TOAST		Ideal casse fed v mois brow and c
Broil	ON	BROIL	Broil	 <p>Lower position</p>  <p>Upper position</p>	Always the ov The c show Use t faster requi side v the p and t Ideal steak Use t that n as ch For t rack side v
Top broiling	ON or Up to 7 minutes	BROIL	Broil		Use t face s d'oue keep opera thus a
Toast	Up to 7 minutes	TOAST	BAKE/TOAST		Set t de



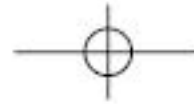

- Your product is equipped with a polarized alternating current line plug (a plug has one flat blade that is longer than the other). This plug will fit into the power outlet only one way. This is a safety feature. If you are unable to insert the plug fully into the outlet, try reversing the plug. If the plug should not fit, call your electrician to replace your obsolete outlet. Do not defeat the safety purpose of the polarized plug.
- Plug the cord into a 120 volt AC outlet.
- The cord length of this product has been selected to reduce the possibility of tangling. If a longer cord is needed, a longer extension cord may be used. It should be rated for at least 15 amps., 120 volts, and have Underwriters Laboratories/CSA listing.
- A six feet long, 15 amp. extension cord may be purchased from your local authorized retailer. If you are using a longer cord, be sure not to let it drape over the working area or dangle where it could be accidentally pulled or tripped over.
- Handle the cord carefully for longer life; avoid jerking or straining the cord at the plug and outlet connections.

- **Note:**

Initial start up operation may result in minimal smell and smoke (about 15 min.). This is due to the protective substance on heating elements which protects them from salt effects during storage.

OPTIONAL ACCESSORIES

- **COOKIE SHEET (G)**

Must be placed directly on the wire rack. Indispensable for baking biscuits and pastries.

- **OVEN LIGHT (B) AND PILOT LAMP (F)**

- If the oven light (B) has been provided for, said light will remain turned ON during the preheating function. The pilot lamp (F) will turn OFF once the selected baking temperature is reached and will turn on and off during cooking.
- If your oven is not provided with the oven light (B), the pilot lamp (F) will light continuously when the oven is switched on (it will not have the function of a temperature indicator).

- **HANDGRIP FOR WIRE RACK (N)**



Use handgrip to bring the wire rack out of the oven when cooking is finished.

COOKING PROGRAMMES

1. HOW TO KEEP FOOD WARM

Place the food to be kept warm on the wire rack

- Set the thermostat dial (C) to the "KEEP WARM" position.
- Set the ON/OFF (D) dial to the "ON" position.

Set the function selector dial to the "TOAST/BAKE" position.



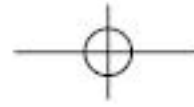

1. Close the door
2. Set the thermostat dial (C) to the desired position/ temperature
3. Turn the ON/OFF timer dial to "ON"
4. Turn the function selector dial to the TOAST/BAKE position.
5. **When baking is finished turn the thermostat dial to the " ● " position and to the "OFF" position.**

• **NOTE:**

We do not recommend the use of glass covers on casseroles. Glass cooking dishes should never be closer than one inch from the heating element.

- **During the bake and toast function, do not put the oven pan (or any other accessory/container) directly on the lower heating element.**

• **HELPFUL BAKING HINTS**

To obtain best performance from this toaster-oven-broiler:

- Do not overfill the oven. Whenever possible, place foods in center of oven.
- Avoid opening the door too frequently to prevent heat loss.
- Foil may be used to cover the baking dish or pan. Be sure the ends of foil are tucked under the edge of the baking dish/pan.

• **TEMPERATURE AND TIME FOR TYPICAL FOODS (baking and roasting)**

The suggested temperature and times will vary depending on the temperature of the food, quantity and personal preference. Times given for meat and poultry are for refrigerator temperatures. **minutes for preheating the oven.** In order to avoid overcooking when using for the first time, set a low temperature. As you use the oven, the best settings will become familiar.

Food	Temperature setting	Approximate time	Notes and tips. (Refer to table on page 4)
Whole chicken 2,5-3 lbs. Unstuffed	400 °F	80-90 min. or until internal temperature of 175 °F in thigh and breast	Turning at half time is required. It is possible to broil (broiling position) inside the oven to reduce spattering.
Pork loin or Rib Roast 2-3 lbs	400 °F	80-90 min. or until internal temperature of 170 °F is reached	Roast as for whole chicken
Beef Sirloin or Rib Roast 3 lbs	400 °F	60-70 min. or until tender and brown	No turning required
Meat loaf 2-2,5 lbs	350 °F	50-60 min.	Use the oven pan. No turning is needed. 1,5 -2 lbs at mince with bread-crumbs, salt,
Baking potatoes			Cut the potatoes in



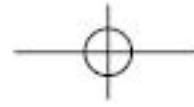

- **TOP BROWNING**

Top browning is ideal for melting, crisping and toasting food surfaces. Use it for open topped casseroles, buttered muffins or browning cooked casseroles.

1. Place the food on the oven pan (or on the cookie sheet, if provided) and place it on the oven rack.
2. Close the door, set both the selector and temperature dials to **BROIL**.
3. Turn the ON/OFF timer knob to **MEDIUM** or to **ON** (for longer browning times)

When experimenting with new uses, watch the food to avoid overbrowning.

When the browning cycle is completed (top surface with desired colour) turn the thermostat dial to **OFF**.

3. INSTRUCTIONS FOR BROILING

Always use the oven pan with the broiling rack for broiling. No preheating of the broiler is required. Do not leave the broiler unattended when in use. Before using the broiler for the first time, wash the pan and the rack with warm, sudsy water. Do not cover the oven wire rack with foil. This prevents fat and oils from draining, causing spatter and smoking, and also restricts proper ventilation.

- **BROILING**

1. Place the oven wire rack as shown in the table on page 4.
2. Place the food to be broiled on the broiling rack (H) (set inside the oven pan), then place the oven pan on the wire rack.
3. **Always leave the oven door open to the stop position (as shown below).**
4. Turn the thermostat dial (C) and the selector dial (E) to "BROIL".
5. Turn the ON/OFF dial to "ON".
6. Turn the function control knob to "BROIL".
7. When broiling is finished, turn the ON/OFF dial to the "OFF" position and turn the thermostat dial to the "●" position. Care should be taken when turning the oven door open, removing the oven pan and disposing of the grease collected while broiling. Use oven mitts and pads.

- **Note:**

While smoke is an inherent characteristic of good broiling, the following tips should be followed to reduce smoking:

- Trim excess fat from meat and score the edges to prevent curling. Dry meat, fish and poultry with paper towel.
- For best results, thaw frozen meats before broiling. These two precautions will reduce the amount of smoke from the broiler.
- Placing the food on the broiling rack allows the juices and fat to drip into the oven pan, reducing spattering while broiling.
- If frozen steaks and chops are broiled, allow 1 and a half to 2 times the required broiling time for unfrozen meat.
- If grease "pops" during broiling, turn the temperature control dial to a lower setting.
- Remove grease from the pan and wash the pan and broiling rack after use.
- The broiler should be cleaned inside after each use. Too much grease accumulation can cause smoke.



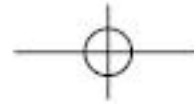

4. DIRECTIONS FOR AUTOMATIC TOASTING

- The capacity of the wire rack (L) is such as to allow the toasting of 6 slices of bread. In any case better results are obtained with 4 slices.
- For toasting, place the slices of bread as shown below:

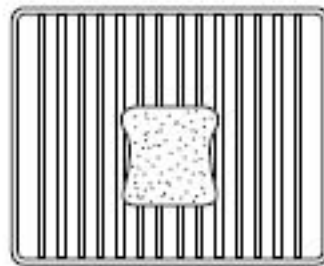

Toasting one slice

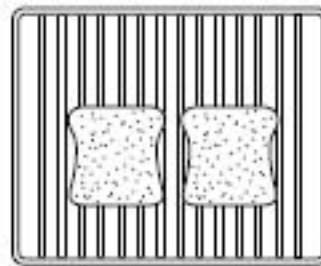

Toasting two slices

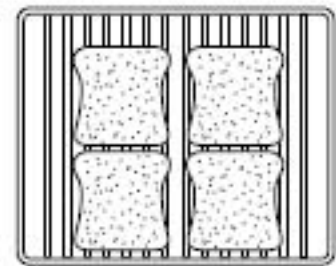

Toasting four slices

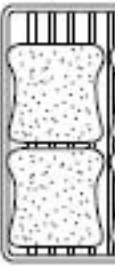

Toasting two slices

For consecutive toasting, turn the toast programming dial to a lower setting.

• INSTRUCTIONS FOR TOASTING

Always use the oven wire rack for toasting bread, sandwiches, English muffins, scones and waffles automatically.

1. Place the wire rack as shown in the table on page 4.
2. Center the food to be toasted on the wire rack. Close the door.
3. Set the thermostat dial to TOAST/BROIL position and the function selector dial to TOAST.
4. The toast programming dial (D) can be set clockwise for light, medium or dark toast or a setting in between.

When using the toaster-oven-broiler for the first time, set the dial (D) to a medium setting and toast two pieces of bread to check for desired brownness. If necessary, adjust the control to a lighter or darker shade.

5. When toasting, both the top and bottom heating element switch on to brown both sides of the bread at the same time. Condensation may build up on the inside of the glass door. This is normal. The condensation will evaporate during the toasting cycle.
6. A ring indicates the end of the set time. The toasting cycle has been completed and the oven will shut off automatically. Turn the thermostat dial to the "●" position.

• Note:

This toaster-oven-broiler is capable of toasting in a wide range of colours, automatically. However, if you prefer a lighter shade of toast, simply interrupt the automatic toasting cycle by turning the ON/OFF knob to "OFF". This will shut the unit off without damaging the oven.

If you prefer a darker shade, restart the toasting cycle by turning the dial (D) clockwise to a darker setting. The desired colour is obtained.

Then switch off manually the thermostat dial and the toast programming dial as soon as the toast is ready. Do not toast earlier.

As you use the oven, the best settings for favourite breads will become familiar.

• HINTS FOR TOASTING SUCCESS

Heavier breads and frozen breads will require a darker setting. One slice of bread will require a darker setting than several slices.



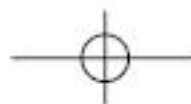

CLEANING AND MAINTENANCE

Always unplug the toaster-oven-broiler and allow it to cool before cleaning. It is designed and engineered with your safety in mind. To assure maximum safe operation, clean the interior regularly to prevent the accumulation of grease and build up of food particles.

1. Remove the wire oven rack.
2. To clean the inside walls, use a damp cloth and a mild liquid soap solution. Never use abrasive or corrosive products or spray detergents.

- **Note:**

Do not clean interior with metal scouring pads. Pieces can break off and create a fire hazard, creating risk of electrical shock.

3. To clean the glass door, use a glass cleaner or a damp cloth. Wipe dry with a clean cloth.
4. To clean the exterior finish, use a damp, sudsy cloth. For stubborn stains, a non-abrasive spray glass cleaner may be used. Do not use metal scouring pads, as they might scratch the finish. Remove cleaning agents by polishing with a dry cloth.
5. The wire rack, the oven pan and the broiling rack may be washed as other kitchen utensils.

- **CLEANING THE BOTTOM OF THE OVEN**

If your oven has a bottom that can be opened:

To clean the bottom of the oven, open the access panel by pressing the latch spring on the bottom of the access panel downwards. (see fig. A/B). Place the oven on its rear panel. This will make cleaning easier.

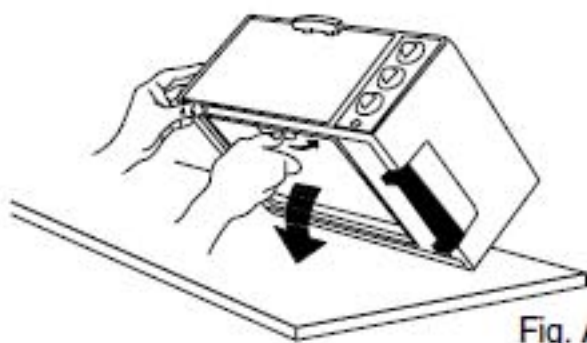

Fig. A



Fig. B

Clean the oven floor after use to avoid build-up of residue, as this will affect the cooking. Remove crumbs or wipe the oven floor with a damp cloth. For stubborn stains, use a nylon brush or a non-caustic cleaner, dry thoroughly before closing.

After cleaning, close the access panel and check that it is locked securely into position.

If your oven has a crumb tray:

Slide the crumb tray out from under the bottom of your oven (see Fig. C). Wash by hand. Should the soilage be difficult to remove, rinse the crumb tray with hot soapy water and if necessary, scour it delicately, without scratching it.

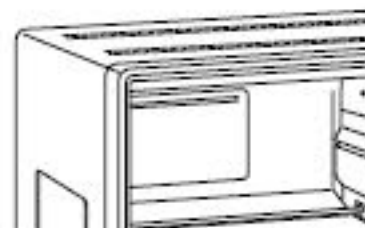



Limited Warranty

What Does This Warranty Cover? We warrant each appliance to be free from defects in workmanship. Our obligation under this warranty is limited to replacement or repair, free of charge, at authorized service centers, of any defective part or parts there of other than parts damaged in use. The appliance to be returned to us, transportation prepaid. This warranty shall apply only if the appliance is used in accordance with the factory directions which accompany it, and on an Alternating Current (AC) circuit.

How Long Does The Coverage Last? This warranty runs for one year from the date of purchase, and is only to the original purchaser for use.

What Does This Warranty Not Cover? This warranty does not cover defects or damages which result from repairs or alterations to the machine outside our factory or authorized service centers. The warranty does not apply to any appliance which has been subject to abuse, misuse, negligence or accidents. Also, incidental damages resulting from the use of this product or arising out of any breach of contract or warranty are not recoverable under this warranty. Some states do not allow the exclusion or limitation of incidental or consequential damages, so the above limitation may not apply to you.

How Do You Get Service? If repairs become necessary or spare parts are needed, please write to:

De'Longhi America Inc.
Park 80 West Plaza One 4th floor
Saddle Brook, NJ 07663
or call Service Tel. No. 1-800-322-3848

De

MISSIS

The above warranty is in lieu of all other express warranties and representations; All implied warranties are limited to the applicable warranty period set forth above. This limitation does apply if you enter into a purchase agreement with De'Longhi. Some states do not allow limitations on how long an implied warranty lasts, so this limitation may not apply to you. De' Longhi does not authorize any other person or company to assume any liability in connection with the sale or use of its appliance.

How Does State Law Apply? This warranty gives you specific legal rights, and you may have other rights which vary from state to state.

