

This Owner's Manual is provided and hosted by [Appliance Factory Parts](#).

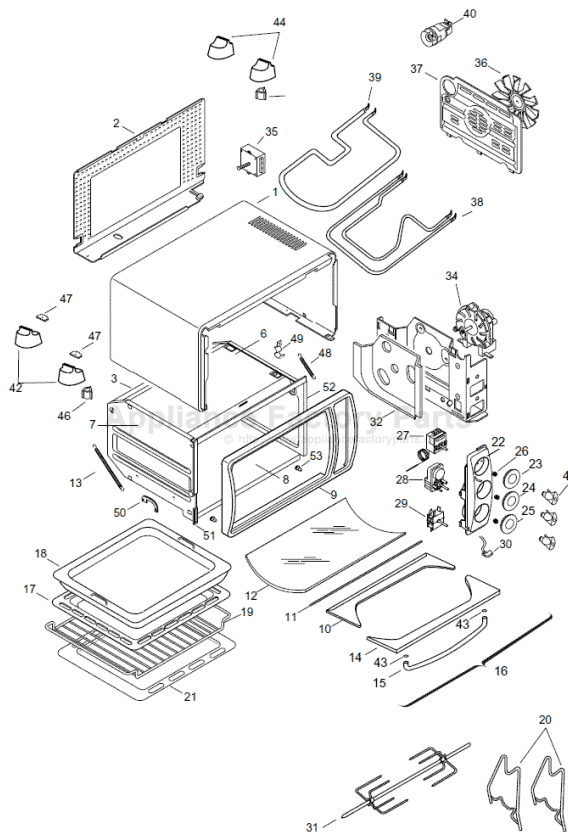

DE'LONGHI AR1070 CHROME-SILVER Owner's Manual

[Shop genuine replacement parts for DE'LONGHI
AR1070 CHROME-SILVER](#)



[Find Your DE'LONGHI Small Appliance Parts - Select From 131 Models](#)

----- Manual continues below -----

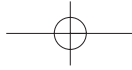

CONVECTION OVEN

FOUR A CONVECTION

HORNO DE CONVECCIÓN

FORNO VENTILADO

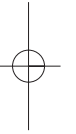

Instructions for use

Mode d'emploi

Instrucciones de uso

Instruções



CONTENTS

CHAP. 1 GENERAL

1.1 Description and accessories provided 3

1.2 Important safeguards 4

1.3 Summary of operation 5

1.4 Installation 6

CHAP. 2 USING THE CONTROLS AND SETTING THE MODES

2.1 Bake and Fan/Bake functions 7

2.2 Broil and top brown function 9

2.3 Keep warm function 10

2.4 Defrost function 10

2.5 Rotisserie function 10

CHAP. 3 CLEANING AND MAINTENANCE

3.1 Care and cleaning 12

ELECTRICAL CONNECTIONS

All it requires is a nearby 120 Volt 60 Hz three-prong grounded power socket.

GROUNDING INSTRUCTIONS

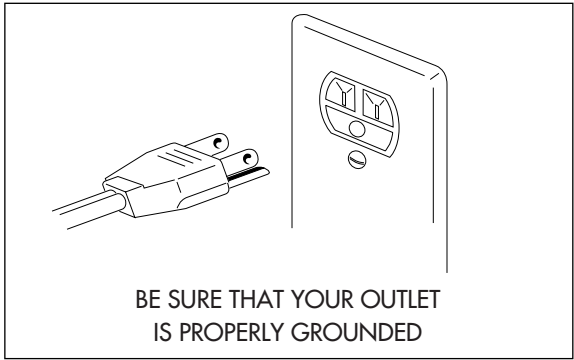

BE SURE THAT YOUR OUTLET IS PROPERLY GROUNDED

This appliance must be grounded. In the event of an electrical short circuit, grounding reduces the risk of electric shock by providing an escape wire for the electric current. This appliance is equipped with a cord having a grounding wire with a grounding plug. The plug must be plugged into an outlet that is properly installed and grounded.

WARNING: IMPROPER USE OF THE GROUNDING PLUG CAN RESULT IN A RISK OF ELECTRIC SHOCK.

If you are uncertain that your outlets are properly grounded, please contact a qualified electrician or serviceman.

If it is necessary to use an extension cord, use only a three-wire extension cord that has a 3-blade grounding plug, and a 3-slot receptacle that will accept the plug on the appliance. The marked rating of the extension cord shall be equal to or greater than the electrical rating of the appliance.

- The cord length of this product has been selected to reduce the possibility of tangling in or tripping over a longer cord. If more cord length is needed, an extension cord may be used. It should be rated no less than 15 amps., 120 volts, and have Underwriters Laboratories/CSA listing.
- A six feet long, 15 amp. extension cord may be purchased from your local authorized service facility. When using a longer cord, be sure not to let it drape over the working area or dangle where someone could accidentally pull or trip over it.
- Handle the cord carefully for longer life; avoid jerking or straining the cord at the plug and appliance connections.

CHAPTER 1 - GENERAL

1.1 - DESCRIPTION AND ACCESSORIES PROVIDED

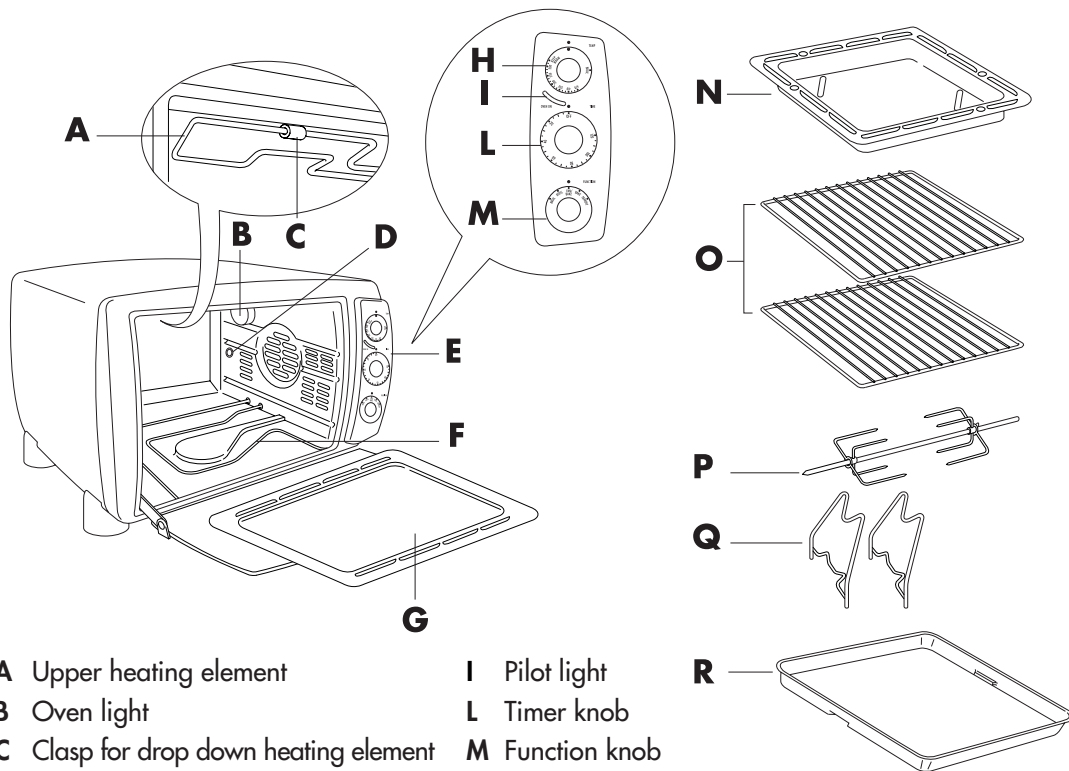

- A Upper heating element
- B Oven light
- C Clasp for drop down heating element
- D Rotisserie spit mount
- E Control panel
- F Lower heating element
- G Crumb tray
- H Thermostat knob
- I Pilot light
- L Timer knob
- M Function knob
- N Shallow pan
- O Wire rack (two provided)
- P Spit
- Q Spit support
- R Lasagna tray

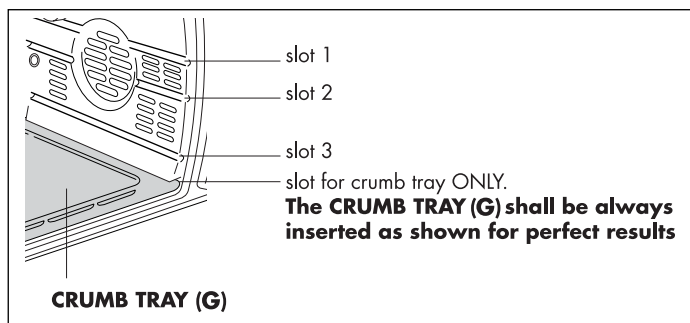

CONVERSION TABLE:	
°C	°F
95	200
107	225
120	250
135	275
150	300
163	325
177	350
190	375
205	400
218	425
233	450
240	470

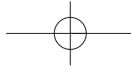

Chapter 1 - General

1.2 - IMPORTANT SAFEGUARDS

When using electric appliances basic safety precautions should always be followed, including the following:

- 1) Read all instructions.
- 2) The temperature of the door or the outer surfaces may be high when the appliance is operating: only ever touch the plastic knobs and handles.
- 3) To protect against electrical shock, do not immerse cord, plugs, in water or other liquid. See instructions for cleaning.
- 4) The appliance is not intended for use by young children or infirm persons without supervision. Young children should be supervised to ensure that they do not play with the appliance.
- 5) Unplug from outlet when not in use and before cleaning. To disconnect the appliance, turn the timer knob (L) to "O" and the thermostat knob (H) to "●". Then unplug the cord from the wall outlet. Allow to cool before putting on or taking off parts and before cleaning the appliance.
- 6) If the supply cord is damaged, it must be replaced by the manufacturer or its service agent or a similarly qualified person in order to avoid a hazard.
- 7) The use of accessory attachments not recommended by the appliance manufacturer may cause injuries.
- 8) Do not use outdoors.
- 9) Do not place heavy objects on the open door. Do not forcefully push the open door down. Do not place hot pans/baking tins (just removed from the oven) onto the open door.
- 10) Do not let cord hang over edge of table or counter, or touch hot surfaces.
- 11) Do not place on or near a hot gas or electric burner, or in a heated oven. Do not place anything on top of the oven while in use.
- 12) Extreme caution must be used when moving an appliance containing hot oil or other hot liquids.
- 13) If the plug gets hot, please call a qualified electrician.
- 14) Do not use this appliance for other than intended use.
- 15) Use extreme caution when removing the shallow pan (N) or disposing of hot grease.
- 16) Do not clean oven with metal scouring pads. Pieces can break off the pad and touch electrical parts creating a risk of electric shock.
- 17) To assure safe operation, oversized utensils or food must not be inserted into the oven.
- 18) A fire may occur if this appliance is covered or touching flammable material, including curtains, draperies, walls, etc. when in operation.
- 19) CAUTION: Never leave the oven unattended when in use (especially when broiling).
- 20) Extreme caution should be exercised when using containers other than ovenproof metal, glass or ceramic.
- 21) Do not store any materials other than the manufacturer's recommended accessories in the oven when not in use.
- 22) Do not place any of the following materials in the oven: paper, cardboard, plastic and the like.
- 23) Do not cover crumb tray or any part of the oven with metal foil; this can cause overheating of the oven. Use aluminum foil on or under food only as directed in the appliance instructions.

THIS PRODUCT IS FOR HOUSEHOLD USE ONLY





SAVE THESE INSTRUCTIONS

WARNING: Once having removed the appliance from the packaging, check that the door is intact. As the door is made from glass, it is fragile, and should be replaced if visibly chipped, scored or scratched. Furthermore, when using, cleaning or moving the appliance, do not slam or bang the door or pour cold liquids on the glass when the appliance is hot.



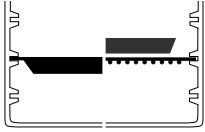
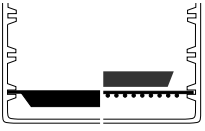
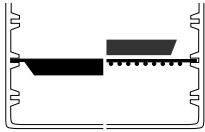
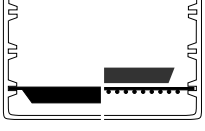

Chapter 1 - General

1.3 - SUMMARY OF OPERATION

PROGRAM	FUNCTION KNOB	THERMOSTAT KNOB	POSITION OF WIRE RACK/ ACCESSORIES	GUIDES	NOTES/TIPS
BAKE	BAKE	200° - 470° F (see table on page 8)	 <p>or</p> 	<p>1</p> <p>2</p> <p>3</p> <p>1</p> <p>2</p> <p>3</p>	<p>You can cook in bake function with the SHALLOW PAN (N) inserted either in slot 2 or 3 or with a ovenproof container placed on the WIRE RACK (O), again inserted either in slot 2 or 3. The LASAGNA TRAY (R) may be also placed on the WIRE RACK (O). Bake casserole, fruit dessert, fish, stuffed vegetables, puddings and other moist foods that don't require browning and crisping.</p>
FAN/BAKE (ONE LEVEL)	FAN/BAKE	200° - 470° F (see table on page 8)	 	<p>1</p> <p>2</p> <p>3</p> <p>1</p> <p>2</p> <p>3</p>	<p>You can cook in fan/bake function with the SHALLOW PAN (N) inserted either in slot 2 or 3 or with a ovenproof container placed on the WIRE RACK (O), again inserted either in slot 2 or 3. The LASAGNA TRAY (R) may be also placed on the WIRE RACK (O). Roast meats and poultry will cook faster. Use of a meat thermometer will help avoid overcooking.</p>
FAN/BAKE (TWO LEVEL)	FAN/BAKE	200° - 470° F	 	<p>1</p> <p>2</p> <p>3</p> <p>1</p> <p>2</p> <p>3</p>	<p>It is possible to cook simultaneously on two level by inserting the accessories as shown. An ovenproof container or the LASAGNA TRAY (R) may be positioned on the WIRE RACK (O). Ideal for foods which can be stirred or turned during the cooking (e.g. roasted potatoes, on one shelf and chicken parts on the second shelf).</p>
BROIL AND TOP BROWN	BROIL	BROIL		<p>1</p> <p>2</p> <p>3</p>	<p>During broiling of hamburger, sausages, kebabs and steaks always put the WIRE RACK (O) with the food in slot 1 and the SHALLOW PAN (N) in slot 2 to collect fat dropping.</p>
				<p>1</p> <p>2</p> <p>3</p>	<p>Use this function to top brown open-face sandwiches, cheese toppings, hors d'oeuvres.</p>

Chapter 1 - General

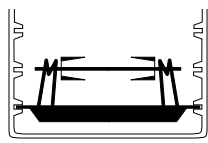
PROGRAM	FUNCTION KNOB	THERMOSTAT KNOB	POSITION OF WIRE RACK/ ACCESSORIES	GUIDES	NOTES/TIPS
KEEP WARM	FAN BAKE	KEEP WARM		1 2 3	Select this function to keep hot food warm. Do not hold food more than an hour or reheat cold food. If not hot enough for serving turn temperature dial up.
DEFROST	DEFROST	<p>●</p> Be sure to keep knob at this position. Only the fan will operate		1 2 3	To thaw frozen food in freezer packaging place it on wire rack or on shallow pan to catch any juices. Do not try to thaw large roasts or allow any food to overthaw
ROTISSERIE	ROTIS.	BROIL		1 2 3	Place the skewer and the supports on the SHALLOW PAN (N) as described on page 11 Then insert the SHALLOW PAN (N) in the slot 3. Ideal for poultry, beef, ecc.

1.4 - INSTALLATION

- 1) Check that the appliance has not suffered any damage due to transportation.
- 2) Place the appliance on a flat, stable surface out of the reach of children (the glass door becomes very hot while the oven is in operation).
- 3) Before using this appliance, move it two to four inches away from the wall or any object on the counter top. **Remove any object that may have been placed on top of the appliance.** Do not use on surfaces where heat may be a problem.
- 4) When a function is started, (except Defrost function) the pilot light (I) turns on.
Note: Initial start-up operation may result in minimal smell and smoke (about 15 min.). This is normal. It is due to the protective substance on heating elements which protects them from salt effects during shipping from the factory.
- 5) Condensation and a grease deposit may form around the door and the air and steam outlet vents. This is normal.
- 6) Before using the appliance for the first time, remove all paper contents such as: protection cardboard, instructions for use, plastic bags and so on.

**PLEASE READ AND KEEP THIS BOOKLET HANDY.
THE IDEAS AND INSTRUCTIONS WILL HELP YOU MAKE FULL USE OF THE OVEN**

CHAPTER 2 - USING THE CONTROL AND SETTING THE MODES

2.1 - BAKE AND FAN/BAKE FUNCTIONS

HEAT CIRC CONVECTION FEATURE WITH FAN/BAKE MODE

To get the most from convection cooking, this De'Longhi oven incorporates our patented Heat Circ design.

How does it work? When using convection mode, the Heat Circ design first pulls air down to the heating elements, where it circulates and becomes very hot. Next, this heated air is transferred into the cooking chamber and circulated there to enhance cooking results as only convection cooking can. The crumb tray is designed with special heat deflectors to precisely direct the process.

De'Longhi's Heat Circ feature is designed so that fan-circulated air is the hottest air in the oven. This enhances the time-saving benefit of convection cooking, and has been proven in our test kitchens to deliver the most consistent cooking results.

In general, meats and poultry can be cooked in less time (a meat thermometer will help to prevent overcooking). Cakes, pies, cookies, etc. can be baked at a lower temperature (see charts and recipes).

BAKE mode is used when browning and crisping are less important or undesirable. Use it, following conventional recipes, for casseroles, stuffed vegetables, fish, lasagna, fruit tarts, cheesecakes and other moist mixtures.

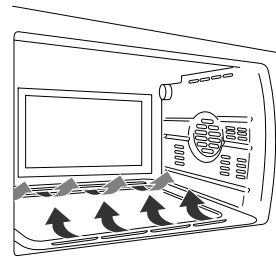
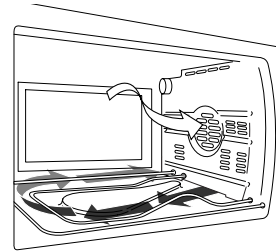

CONVECTION BAKING OF CONVENIENCE FOODS

Many convenience foods can be successfully baked or heated by convection on the FAN/BAKE function. In general, follow the package directions for temperature and time. **However, lower the temperature by 25°F.** for more even cooking of larger items, frozen foods (except waffles and pancakes) and packaged casserole mixtures. There is such a wide choice of convenience foods on the market and variations in packaging, quantities and initial temperatures (frozen, refrigerated and shelf temperature) that it's best to follow the package instructions. Check the food 5 to 10 minutes before the time is up; you may need to adjust the time and/or temperature for best results.

Here are some tips for different types of convenience foods:

- If directions call for placing the food container on a metal pan or cookie sheet to avoid spills or to aid even cooking, use the shallow pan provided. Use it or the cookie sheets provided for foods, such as rolls, cookies, turnovers or frozen French fries, breaded fish or chicken pieces, that are placed directly on a pan or cookie sheet.
- Some frozen foods come in "oven-proof" plastic or paper containers which can be cooked in a microwave oven and, within limits, a conventional oven. Be sure to follow directions for maximum baking temperature. The container can melt or scorch if too high a temperature is used. To be on the safe side, set the oven 25°F. lower than the recommended temperature.
- When baking packaged mixtures (such as scalloped potatoes, macaroni and cheese, brownies, corn bread, coffee cake and cake mixes) check the package directions for recommended sizes of pan, casserole or dish and the proper baking times for each. A 9-inch round or an 11/7 - by 11/2 inch rectangular pan will fit in the oven with room on all sides for air circulation. Layer cake mixes can be baked one layer at a time in a 8- or 9-inch round pan or all of the batter in a 3-inch deep 9-inch round bundt or spring-form pan.

Tips for convection baking and roasting

To bake:

- Turn the thermostat knob (H) to the desired oven temperature
- Turn the timer knob (L) to the desired cooking time.
- Turn the function knob (M) to FAN/BAKE for convection cooking and to BAKE for traditional cooking.
- **When the cooking is finished, turn the thermostat knob (H) to the "●" position and the timer knob (L) to "O" position.**

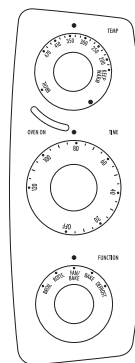

Chapter 2 - Using the control and setting the modes

TEMPERATURE AND TIME FOR TYPICAL FOODS

The suggested temperature and times will vary depending on the temperature of the food placed in the oven, the quantity and personal preference. Times given for meat and poultry are for refrigerator temperature. **Add five minutes for preheating the oven.**

FOOD	FUNCTION	TEMPERATURE SETTING	APPROX. TIME	NOTES AND TIPS
Whole chicken 11-12 lbs. Unstuffed.	FAN BAKE	350°F to 400°F	120 min. or until internal temperature of 175°F in thigh and breast	Put the poultry or the meat directly in the SHALLOW PAN (N) inserted in the slot 3. If you desire to cook in a oven-proof container, put the container on the WIRE RACK (O) inserted in slot 3.
Pork Loin or Rib Roast, 3 - 6 lbs.	FAN BAKE	350°F to 400°F	90 min. or until internal temperature of 170°F is reached.	
Pork Baby Back Ribs 1.75 - 2 lbs. in 6 - to 10 - inch strips.	FAN BAKE	300°F for 25 min. then BROIL for 30 min.	Total time 50 min. or until brown and very tender.	Use SHALLOW PAN (N) lined with foil inserted in the lower position. See recipe to follow for full directions.
Beef Sirloin or Rib Roast 5 - 7 lbs, boned.	FAN BAKE	350°F to 400°F	25 min./lb. for rare 30 min./lb for medium 35 min./lb. well	Have roast tied for even cooking. Use SHALLOW PAN (N) in low or central position as oven space allows.
Cornish Hens 1.5 lbs. each, two split into four halves.	FAN BAKE	350°F to 400°F	45 - 50 min. or until tender and juice is clear when pierced with fork.	Roast on SHALLOW PAN inserted in central position, skin side up. Brush with orange marmalade or honey. Turn and brush several times until done.
Baking Potatoes	BAKE	400°F to 450°F	For 6 to 8 large potatoes. 45 - 50 min. or until fork-tender.	Wash and pierce raw potatoes with fork. Rub skins with salad oil if desired. Bake on the SHALLOW PAN (N) in the lower position.
Pizza, homemade.	BAKE	400°F to 450°F	20 - 25 min. depending on size and topping. Bake until bubbling hot and crust crisp.	Insert the SHALLOW PAN (N) on the slot 3. Grease the pan or use the special oven paper.
Cakes: Layer, Sheet cake or Loaf cake. Pies: Fruit, 9- inch double crust.	FAN BAKE	350°F to 400°F	Follow traditional recipe timing but lower temperature by 25 to 50°F.	Insert the WIRE RACK (O) on the SHALLOW PAN (N) in slot 2. In case of tall rising cakes, place the tray in the slot 3.
Brownies, Bar, Cookies	FAN BAKE	350°F to 400°F	Follow traditional recipe timing but lower temperature by 25 to 50°F. Use 7x11 inch or 8-9 inch square pan or oven-glass dish.	Insert the WIRE RACK (O) or the SHALLOW PAN (N) in slot 2. Grease the pan accurately if required by the recipe.

The chart and recipe cover various types of food. You can adapt your own favorite foods and recipes by following the directions for similar foods.

Chapter 2 - Using the control and setting the modes

2.2 - BROIL AND TOP BROWN FUNCTIONS

Tips for broiling typical foods

- Turn the thermostat knob (H) to position BROIL
- Turn the timer knob (L) to the desired cooking time.
- Turn the function knob (M) to position BROIL
- When the function and the thermostat knob (M) are set to the BROIL position, only the top element heats at full power.

When broiling is finished, turn the timer knob to the "O" position and the thermostat knob to the "●" position.

Preheat the oven for 5 minutes, with the door slightly ajar (as highlighted in Figure 1). Once the preheating time is complete, place the food being grilled directly on the wire rack (Figure 2) and close the door, leaving it ajar, as shown in Figure 3; remember to turn the food half way through cooking.

Important: for best results, place the food on the wire rack (O), leaving an empty space of around 1 in near the door (see Figure 2).

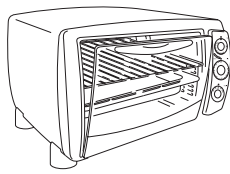
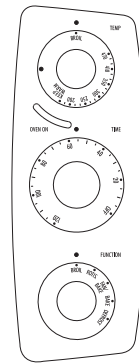

fig. 1

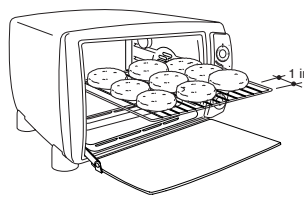

fig. 2

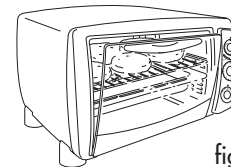

fig. 3

To top-brown casseroles with crumb or cheese toppings, place the shallow pan directly in slot 1; if the food has been prepared on a container, put the container on the wire rack inserted in slot 2 (as shown in the figure 4).

NOTE: Oven-glass dishes should not be exposed to direct broiler heat.

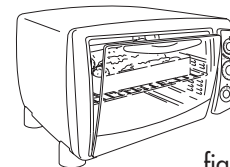

fig. 4

SUGGESTED BROILING TIMES

FOOD	WEIGHT OR THICKNESS	APPROX. TIME (Turn at half time)
Beef Sirloin, Porterhouse Steak	1- 1 1/2 in.	Rare 12 - 15 min. Medium 16 - 18 min.
Beef Flank Steak, Filet	3/4 - 1 in.	Rare 10 - 12 min. Medium 13 - 16 min.
Hamburger	1 in.	Medium-well 15 - 18 min.
Pork Chop	3/4 - in.	Well 18 - 22 min.
Fish Fillets, Steak (See note)	1/2 - 1 in.	10 - 16 min.
Chicken Piece, Broiler-fryer	3 - 4 lb.	40 - 50 min. until juices run clear when fork-tested and no pink when cut.
Bacon, Sausage, Links or Patties	Up to capacity of broil-rack.	10 - 15 min. for crisp bacon, well-done sausage.

Since fish is non-fatty it can be broiled directly on shallow pan. Broil until it flakes easily with a fork. Thin fillets need not to be turned.

Chapter 2 - Using the control and setting the modes

To correctly toast bread, place the slices as shown in the figure to the side, that is, leaving 1 in of free space at the ends of the wire rack.

FOR TOASTING BREAD ONLY;

the oven door must be closed completely (as shown in the figure to the side)

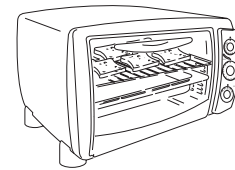
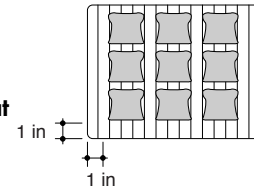

2.3 - KEEP WARM FUNCTION

- Turn the thermostat knob (H) to position KEEP WARM
- Turn the function knob (M) to position FAN BAKE
- Turn the timer knob (L) to desired time.
- When food has finished cooking it can be held at this setting on the temperature control for up to an hour. Any longer can dry out the food and risks spoilage. If the oven set to 200°F seems too hot, to obtain a lower serving temperature turn the thermostat dial back to the KEEP WARM mark. Do not attempt to hold food longer or to rewarm cold food at this setting. When finished, turn the timer knob (H) to the "O" position and the thermostat knob to the "●" position.

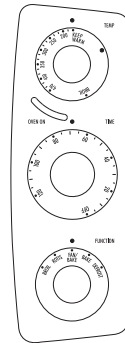

2.4 - DEFROST FUNCTION

- Turn the thermostat knob (H) to position "●"
- Turn the function knob (M) to position DEFROST
- Turn the timer knob (L) to desired time.
- Put the frozen food directly on the WIRE RACK (O) inserted in slot 2. Put the SHALLOW PAN (N) in slot 3 in order to catch the water dropping from the load during the defrosting process.
- Portions and pieces of raw meat, poultry and fish, frozen soups, pastry, fruit or leftovers will thaw more quickly on this setting than on a counter or in the refrigerator.
- Thaw only pieces or portions small enough to thaw in an hour or less and do not let food come to room temperature. Thawed food held too long or at a warm temperature can cause serious illness. Large amounts of food should be defrosted in a refrigerator.

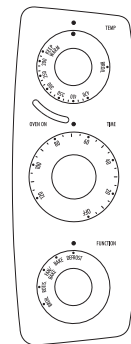

2.5 - ROTISSERIE FUNCTION

This function is ideal for cooking chickens on the spit, fowl in general, roast pork and veal. The rotisserie function can be used for load of up to 10 pounds.

- Turn the thermostat knob (H) to position BROIL
- Turn the function knob (M) to position ROTIS
- Turn the timer knob (L) to desired cooking time.

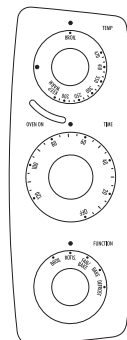

Chapter 2 - Using the control and setting the modes

Operate as follows:

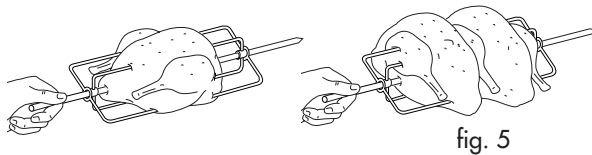

fig. 5

Place the food on the spit (P) and hold it firm using the forks (for best results, tie the meat using kitchen string).

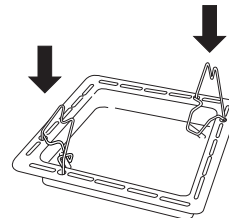

fig. 6

Place the spit supports (Q) on the dripping pan, in the holes provided.

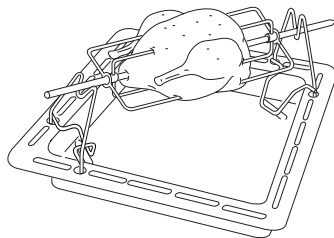

fig. 7

Place the spit on the supports.

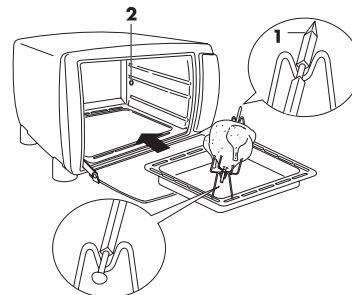

fig. 8

Slide the dripping pan with the food being cooked into the lower guide (3), tilting the spit supports (Q) to the left. **Make sure the point of the spit 1 is facing forwards and is correctly inserted into the hole 2.**

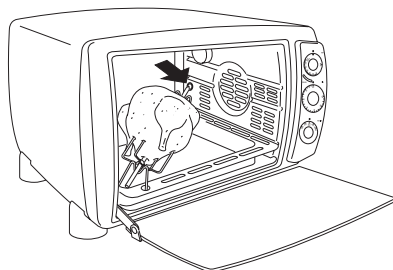

fig. 9

Once the dripping pan is in place, push the spit into the turnspit mount (D), tilting the spit supports (Q) to the right.

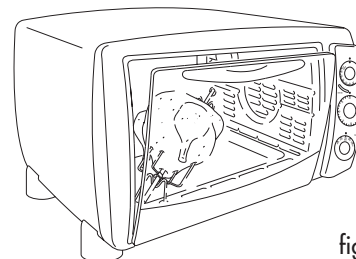

fig. 10

Close the door, leaving it slightly ajar, as highlighted in the figure.

For information on the cooking times, refer to the instructions in the table below.

FOOD	WEIGHT	APPROX. TIME
Chicken	4-5 lbs.	120 min.
Chickens (2)	9-10 lbs.	180 min.
Rost pork	3-4 lbs.	90 min.
Turkey	8-10 lbs.	180 min.

The rotisserie function is designed for use with a strict maximum load of 10 pounds. For example, please note that turkey at maximum 10 pound weight likely requires binding ties to comfortably clear the drip pan. Therefore, it is advised to be conservative with maximum weight when shopping for rotisserie birds. For larger loads, we recommend the Fan/Bake mode.

CHAPTER 3 - CLEANING AND MAINTENANCE

3.1 - CARE AND CLEANING

Always unplug the oven-broiler and allow it to cool before cleaning. This unit has been designed and engineered with your safety in mind. To assure maximum safe operation, keep unit clean free of grease and build up of food particles.

The internal cavity of your oven is covered with a special enamel to which splashes and food particles do not stick, thus making cleaning particularly simple. Do not clean interior with metal scouring pads.

Pieces can break off and touch electrical parts, creating risk of electrical shock.

To clean the glass door, use a glass cleaner or a damp cloth. Wipe dry with a clean cloth. To clean the exterior finish, use a damp, sudsy cloth. For stubborn stains, a non-abrasive liquid cleaner or spray glass cleaner may be used. Do not use metal scouring pads, as they might mar the finish. Always remove cleaning agents by polishing with a dry cloth.

Slide the crumb tray (G) out from under the bottom of your oven (see fig. 11). Wash by hand. Should the soilage be difficult to remove, rinse the crumb tray with hot soapy water and if necessary, scour it delicately, without scratching it.

To make the cleaning of the inside of the oven easier, the upper heating element (A) can be lowered by pulling the clasp for drop down heating element (C) (fig. 12-13).

IMPORTANT: after cleaning, reposition and reattach the electrical element (fig. 14). **The oven must be not used with the element in the lowered positioned.**

OVEN LIGHT

The oven light (B) is always on when the oven is on. To replace the bulb, proceed as follows:

- unplug the appliance from the power socket
- unscrew the protective glass cover (X), by turning it anti-clockwise, and replace the bulb (Y) with a new one of the same type (see Fig. 15). Replace the protective glass cover (X).

Only use bulbs suitable for ovens (T572°F)

N.B. The oven can still be used even if the bulb is burnt-out

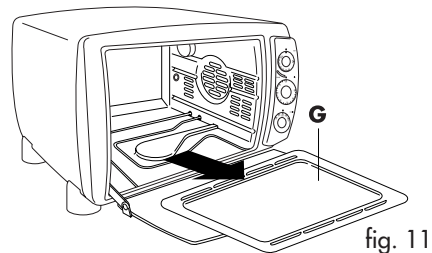

fig. 11

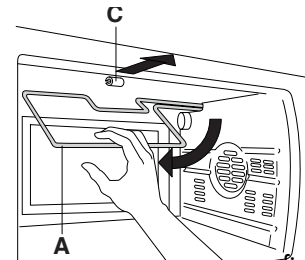

fig. 12

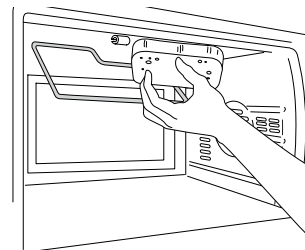

fig. 13

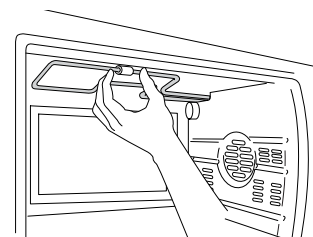

fig. 14

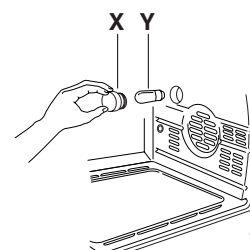

fig. 15



LIMITED WARRANTY

What does the warranty cover?

We warrant each appliance to be free from defects in material and workmanship. Our obligation under this warranty is limited to repair at our factory or authorized service center of any defective parts or part thereof, other than parts damaged in transit. In the event of a products replacement or return, the unit must be returned transportation prepaid. The repaired or new model will be returned at the company expense. This warranty shall apply only if the appliance is used in accordance with the factory directions, which accompany it, and on an Alternating current (AC) circuit.

How long does the coverage last?

This warranty runs for one year (1) from the purchase date found on your receipt and applies only to the original purchaser for use.

What is not covered by the warranty?

The warranty does not cover defects or damage of the appliance, which result from repairs or alterations to the appliance outside our factory or authorized service centers, nor shall it apply to any appliance, which has been subject to abuse, misuse, negligence or accidents. Also, consequential and incidental damage resulting from the use of this product or arising out of any breach of contract or breach of this warranty are not recoverable under this warranty. Some states do not allow the exclusion or limitation of incidental or consequential damage, so the above limitation may not apply to you.

How do you get service?

If repairs become necessary please contact our toll free hotline at **1-800-322-3848** or log onto our website at **www.delonghi.com**.

The above warranty is in lieu of all other express warranties and representations. All implied warranties are limited to the applicable warranty period set forth above. This limitation does not apply if you enter into an extended warranty with De'Longhi. Some states do not allow limitations on how long an implied warranty lasts, so the above exclusions may not apply to you. De'Longhi does not authorize any other person or company to assume for it any liability in connection with the sale or use of its appliance.

How does state law apply?

This warranty gives you specific legal rights, and you may also have other rights, which vary from state to state.