

This Owner's Manual is provided and hosted by [Appliance Factory Parts](http://ApplianceFactoryParts.com).

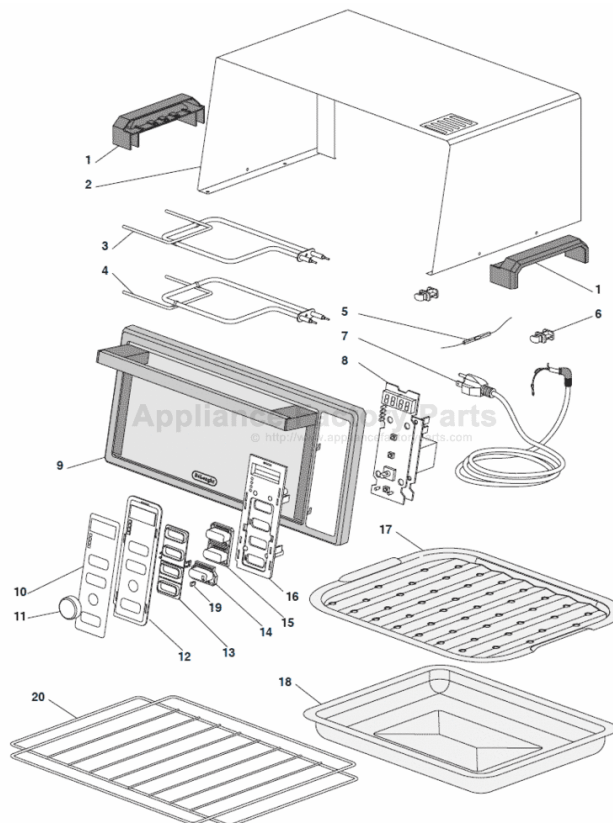

DE'LONGHI DO420 Owner's Manual

[Shop genuine replacement parts for DE'LONGHI DO420](#)



[Find Your DE'LONGHI Oven Parts - Select From 110 Models](#)

----- Manual continues below -----

ELECTRIC OVEN FOUR ÉLECTRIQUE HORNO ELÉCTRICO FORNO ELETTRICO DO420

Register this product on-line and receive a free trial issue of Cook's Illustrated. Visit www.delonghiregistration.com.

Visit www.delonghi.com for a list of service centers near you. (U.S. and Canada Only)

Enregistrez ce produit en ligne et recevez un numéro gratuit de Cook's Illustrated. Visitez www.delonghiregistration.com.

Visitez www.delonghi.com pour y voir une liste des centres de réparation proches de chez vous. (É.-U. et Canada uniquement)

Registre este producto en línea y reciba un ejemplar gratis de Cook's Illustrated. Visite www.delonghiregistration.com.

Visite www.delonghi.com para ver la lista de centros de servicios cercanos a usted. (Solamente en los Estados Unidos y Canada)

Registra questo prodotto "on-line" per ricevere una copia omaggio della rivista Cook's Illustrated. Visita www.delonghiregistration.com

Visita www.delonghi.com per una lista dei centri di servizio a te più vicini. (Solo negli Stati Uniti e Canada)

Instructions for use

Keep these instructions

Mode d'emploi

Conservez cette notice

Instrucciones para el uso

Repase y guarde estas instrucciones

Lea cuidadosamente este instructivo antes de usar su aparato.

Istruzioni per l'uso

Leggere e conservare queste istruzioni

ELECTRONIC CHARACTERISTICS: CARACTÉRISTIQUES ÉLECTRIQUES:
CARACTERISTICAS ELECTRICAS: CARATTERISTICHE ELETTRICHE:
120V~60Hz 1400W

DeLonghi

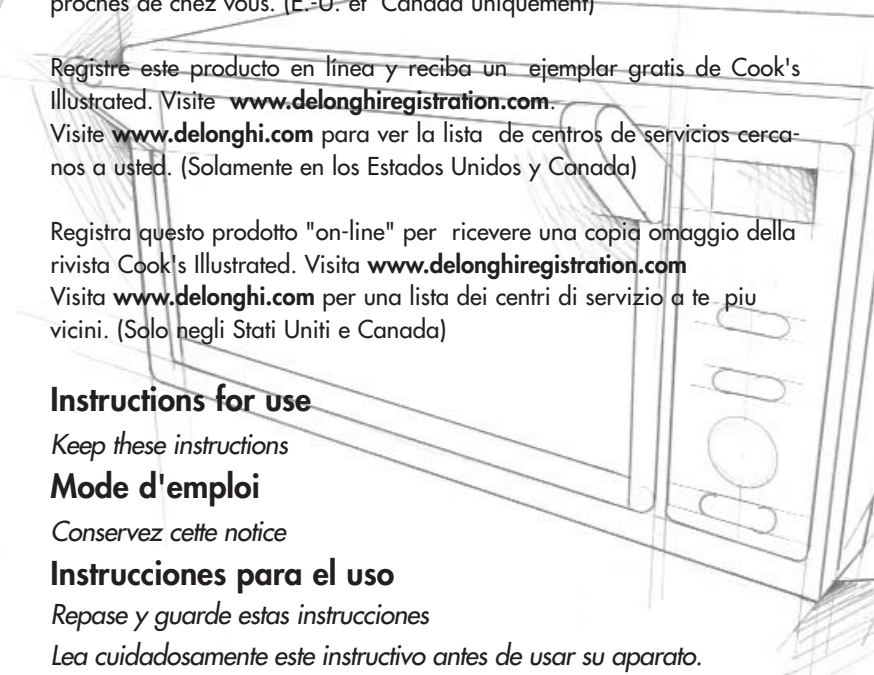

ELECTRICAL CONNECTION

Only use a three-pin, 120 Volt, 60 Hz power outlet

GROUNDING INSTRUCTIONS

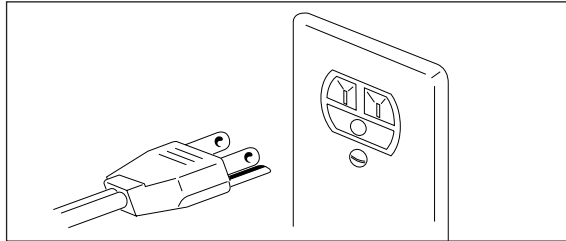

MAKE SURE THAT THE PLUG IS CORRECTLY GROUNDED

This appliance must be grounded: in the event of short circuits, the ground connection reduces the risk of electric shock, allowing the electrical current to be dispersed.

This appliance is fitted with a power cable with ground wire.

The plug must be connected to a power outlet that has been correctly installed and grounded.

WARNING: IMPROPER USE OF THE GROUND WIRE MAY LEAD TO THE RISK OF ELECTRIC SHOCK.

If you are not sure that the power outlet is properly grounded, contact a qualified electrician.

If an extension cord is required, only use three-wire extension cords with three-pin plugs and sockets that fit the plug on the appliance.

The capacity of the extension cord must be greater than or equal to the rated power input of the appliance.

- The length of the power cable for this appliance has been devised so as to avoid the possibility of tripping on or getting entangled in a long cable.
If a longer cable is required, an extension cord can be used with a rated capacity not below 15 amps, 120 volt and with UL/CSA approval.
- A six-foot long extension cord, with a 15 amp rating, is available from authorized resellers.
When using an extension cord, make sure it does not hang loose in the work area or where it can be pulled on by children or where someone may accidentally trip on it or get entangled in it.
- Handle the power cable with care for longer life; avoid pulling or stressing the cable around the connectors to the power outlet and the appliance.

CONVERSION TABLE

°C	°F
95.....	200
107.....	225
120.....	250
135.....	275
150.....	300
163.....	325
177.....	350
190.....	375
205.....	400
218.....	425
233.....	450

CONTENTS

SECTION 1 GENERAL	
1.1	Control panel 3
1.2	Description of the appliance 4
1.3	Important safeguards 5
1.4	Summary table 6
1.5	Installation 6
SECTION 2 USING THE CONTROLS AND SETTING THE MODES	
2.1	Setting the clock 7
2.2	BAKE mode 8
2.3	BROIL mode 10
2.4	TOAST mode 11
2.5	KEEP WARM mode 12
SECTION 3 CLEANING AND MAINTENANCE	
3.1	Care and cleaning 13
3.2	Cleaning the drop down crumb tray 13

SECTION 1 - GENERAL

1.1 - CONTROL PANEL

- 1 Display
- 2 TOAST indicator light
- 3 BAKE indicator light
- 4 BROIL indicator light
- 5 KEEP WARM indicator light
- 6 MODE button
- 7 TEMP./SELECT/CLOCK button
- 8 TIME/TOAST COLOR knob
- 9 START/STOP button
- 10 ON indicator light

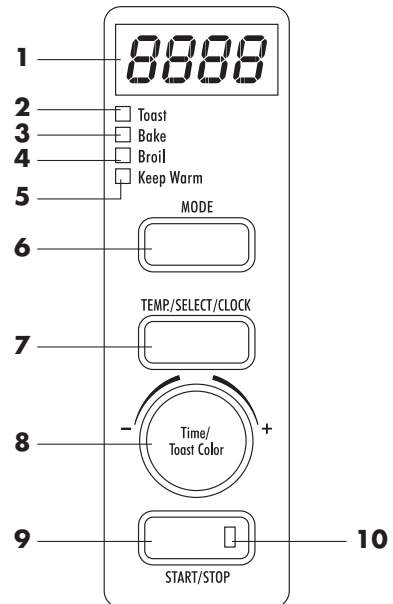

1.2 - DESCRIPTION OF THE APPLIANCE

- A Control panel
- B Glass door
- C Bottom heating element
- D Wire rack
- E Bake pan
- F Top heating element
- G Upper guide
- H Lower guide
- I Drop down crumb tray
- J Broil rack

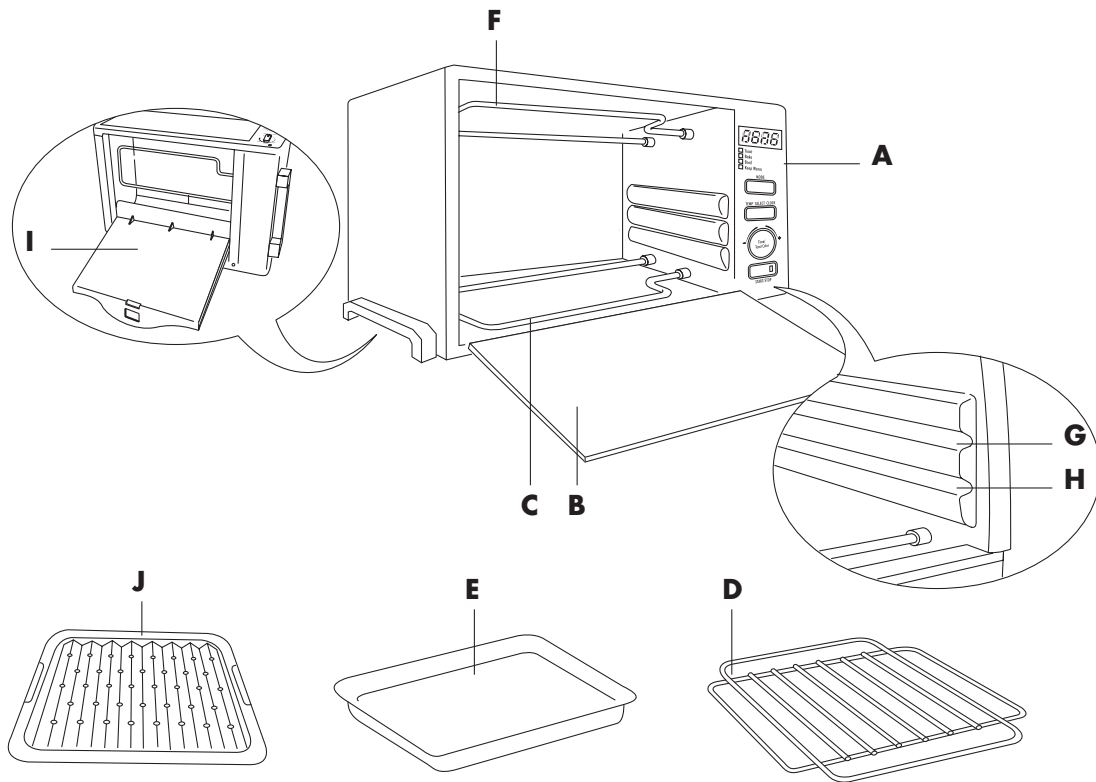

1.3 - IMPORTANT SAFEGUARDS

When using electrical appliances, a number of fundamental safety rules must be observed, including the following:

1. **READ ALL THE INSTRUCTIONS**
2. Do not touch the hot surfaces. Only use the knobs or handles to operate the appliance.
3. Before using the appliance, move it 2 inches (5/10 cm) away from the wall and any other object that is on the same surface. Remove any objects located above the appliance. Do not use on surfaces that may be damaged by the heat.
4. To avoid electric shock, do not immerse the appliance in water. See the instructions for cleaning.
5. If the appliance is used when children are around, pay careful attention to the metal walls of the oven and the door, which become very hot.
The appliance must not be used by children without supervision.
Make sure that children do not play with the appliance.
6. Unplug the appliance from the power outlet when this is not being used or before cleaning it. Always press the START/STOP button (9) to ensure the unit is off before unplugging the appliance.
Wait for the appliance to cool down before fitting or removing any parts.
7. Never operate the appliance with the cable or the plug damaged, if any malfunctions have occurred, or if the appliance has been damaged in any way.
Take the appliance to the nearest authorized service center, which will inspect it and, if necessary, will adjust or repair it.
8. The use of accessories that are not recommended by the manufacturer may cause injuries.
9. Do not use outdoors.
10. Do not let the power cable hang from the counter or come into contact with hot surfaces.
11. Do not place the appliance above or near a gas or electric stove.
12. Use maximum care when moving the appliance if it contains hot oil or other hot liquids.
13. If the plug heats up, contact a qualified electrician.
14. Do not use this appliance for purposes other than those it has been designed for.
15. Use maximum care when removing the bake pan or discarding hot fat drippings.
16. Do not use scouring pads to clean the appliance, small particles may detach and cause electric shocks.
17. To ensure the safe operation of the appliance, never introduce foods or utensils that are too large for the oven.
18. If the appliance, when operating, is covered by or comes into contact with flammable materials, such as curtains, fabrics or wall coverings etc., these may catch fire.
19. **WARNING: Never leave the appliance unattended when operating (especially when broiling or toasting).**
20. When broiling, the bake pan, broil and wire racks must be used as described in the instructions on page 6.
21. Extreme care must be taken when using containers made from materials other than glass, metal or oven-proof ceramics.
22. Do not place any objects in the oven when it is not being used, apart from the accessories recommended by the manufacturer.
23. Do not place any of the following materials into or on top of the oven: paper, cardboard, plastic and the like.
24. Do not cover parts of the oven with metal foil, to avoid overheating.
25. To switch the appliance off, press the START/STOP button (9) to ensure the unit is off.

This product is designed exclusively for household use



SAVE THESE INSTRUCTIONS

WARNING: After having removed the appliance from its packaging, check that the door is intact.

The door is made from glass and is, therefore, fragile. If it is visibly chipped, scored or scratched, it should be replaced.

While using, cleaning or moving the appliance, avoid slamming or knocking the door. Do not pour cold liquid onto the glass while the appliance is hot.

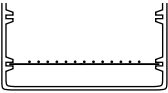
1.4 - SUMMARY TABLE

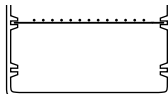
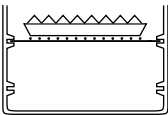
Program	MODE button	TEMP./SELECT/ CLOCK button	Wire rack and accessory position	Notes/Tips
Keep warm	KEEP WARM	180 °F		-
Traditional oven cooking	BAKE	200°F - 450°F		Ideal for cooking stuffed vegetables, fish, and small poultry. For details on how to use the accessories, refer to the table on page 9.
Toast	TOAST	T1-T7 FR T1-T7		Ideal for toasting slices of bread.
Broiling and top browning	BROIL	bri		Broil function is ideal for all types of traditional grilling: hamburgers, hot dogs, kebabs, etc. Use the top browning function to top brown open-face sandwiches, cheese toppings, and hors d'oeuvres.





1.5 - INSTALLATION

- 1) Check that the appliance has not suffered any damage due to transportation.
- 2) Place the appliance on a flat, stable surface out of the reach of children (the glass door becomes very hot while the oven is in operation).
- 3) Before using this appliance, move it two inches away from the wall or any object on the counter top. **Remove any object that may have been placed on top of the appliance.** Do not use on surfaces where heat may be a problem.
- 4) Initial start-up operation may result in minimal smell and smoke (about 15 min.). This is normal. It is due to the protective substance on heating elements which protects them from salt effects during shipping from the factory.
- 5) When a function is started, the ON indicator light (10) will illuminate.

SECTION 2 - USING THE CONTROLS AND SETTING THE MODES

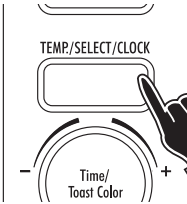
2.1 - SETTING THE CLOCK

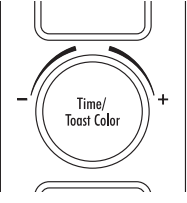
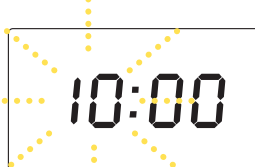
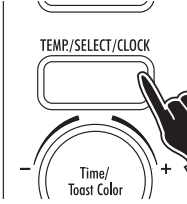
- When the appliance is connected to the power supply for the first time, or after a power outage, four dashes will appear on the display (---). In order to set the time of day, proceed as described below:

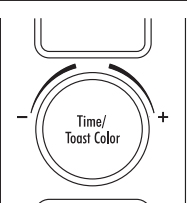
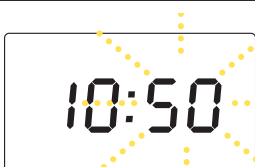
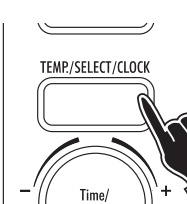
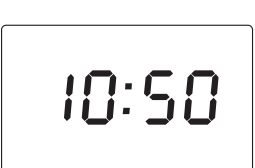
	<p>1 Press for 5 seconds the TEMP./SELECT/CLOCK button (7) (the hours flash on the display).</p>	
	<p>2 Turn the TIME/TOAST COLOR knob (8) to the desired time (hours). The time set will begin blinking on the display.</p>	
	<p>3 Press the TEMP./SELECT/CLOCK button (7) (the minutes flash on the display).</p>	
	<p>4 Turn the TIME/TOAST COLOR knob (8) to the desired time (minutes). The time set will begin blinking on the display.</p>	
	<p>5 Press the TEMP./SELECT/CLOCK button (7) to confirm. It is possible to press the button at any time during cooking to display the current time (the display shows the time set).</p>	

- If you wish to change the hour on the display once it has been set, press the TEMP./SELECT/CLOCK button (7) before proceeding to set the new time as described above.
- It is possible to display the current time even after starting a function, by pressing the TEMP./SELECT/CLOCK button (7) (the time is displayed for 2 seconds).

2.2 - BAKE MODE

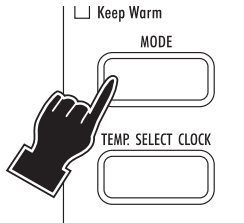

1 Press the MODE button (6) until the BAKE indicator light (3) is on. The display will show the temperature **350°F**.



- Toast
- Bake
- Broil
- Keep Warm

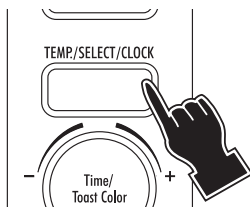

2 If necessary, the desired temperature can be modified by pressing repeatedly the TEMP./SELECT/CLOCK button (7). The available temperatures are: 200 - 250 - 275 - 300 - 325 - 350 - 375 - 400 - 425 - 450°F. The display will show the chosen temperature.

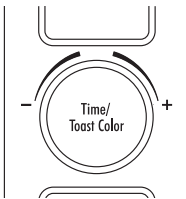

3 Set the cooking time (max 2 hours) by turning the TIME/TOAST COLOR knob(8).

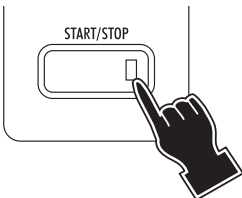
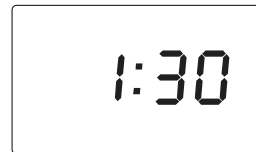

4 Press the START/STOP button (9). The oven will start the countdown. At the end of the set time the control will emit 3 "beeps" and the display will return to stand-by (showing the time of the day, if previously set).

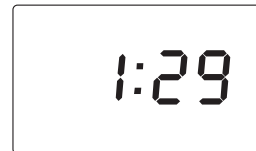

NOTES:

- If the cooking time is not set (skipping point 3), the display will show the countdown starting from the default duration of 30 minutes.
- The set time can be modified during cooking by simply repeating point 3. The countdown will automatically restart 3 seconds after the last setting.
- To display the current temperature (during cooking), simply press the TEMP./SELECT/CLOCK button (7). To modify the set temperature, press again, within 3 seconds, the TEMP./SELECT/CLOCK button until the new desired setting is displayed.
- If the START/STOP button (9) is not pressed within 3 minutes from the previous setting, the control will return to stand-by.

TIPS FOR GOOD RESULTS:

- Place the wire rack (D) in the lower guide (H).
- The oven should always be preheated. Wait for the audible signal (3 short “beeps”) before placing the bake pan (E) with food in the oven.
- The cooking process can be stopped in any moment by pressing the START/STOP button (9).

Food	Temperature	Times	Wire rack position	Comments and tips
Pizza	425°F	17 min.	lower	Use the bake pan.
Bread	400°F	25 min.	“	Use the bake pan greased with oil.
Lasagna	425°F	20 min.	“	Use an ovenproof dish, turn after 10 min.
Macaroni and cheese	425°F	20 min.	“	Turn the bake pan halfway through cooking.
Chicken	400°F	70-80 min.	“	Use the bake pan, turn around after 38 min.
Roast pork	400°F	70 min.	“	Use the bake pan, turn around after 35 min.
Meatballs	350°F	55 min.	“	Use the bake pan, turn around after 30 min.
Fish	400°F	35 min.	“	Use the bake pan, turn after 16 minutes.
Stuffed calamari	400°F	30 min.	“	Use an ovenproof dish, turn halfway through cooking.
Roasted potatoes	400°F	50 min.	“	Use the bake pan, mix twice.
Tomatoes “au gratin”	400°F	40 min.	“	Use the bake pan greased with oil and turn after 20 min.
Zucchini with tuna	400°F	40 min.	“	Use the bake pan greased with oil and turn after 20 min.
Jam tarts	350°F	40 min.	“	Use the bake pan.
Strudel	350°F	40 min.	“	Use the bake pan.
Biscuits (shortbread)	350°F	14 min.	“	Use the bake pan.

2.3 - BROIL MODE

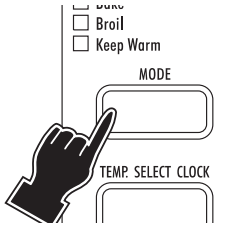

- 1 Press the MODE button (6) until the BROIL indicator light (4) is on. The display will show the message *BRL*.



- Toast
- Bake
- Broil
- Keep Warm

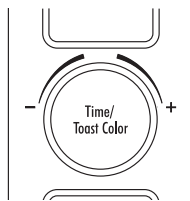

- 2 Set the cooking time (max 1 hour) by turning the TIME/TOAST COLOR knob (8).

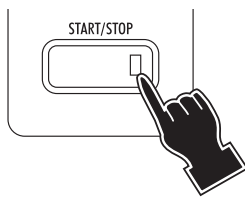
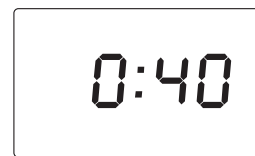

- 3 Press the START/STOP button (9). The oven will start the countdown. At the end of the set time the control will emit 3 "beeps" and the display will show *END*.

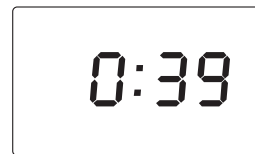

NOTES:

- If the cooking time is not set (skipping point 2), the display will show the countdown starting from the default duration of 15 minutes.
- If the START/STOP button (9) is not pressed within 3 minutes from the previous setting, the control will return to stand-by.

TIPS FOR GOOD RESULTS:

- The oven should not be preheated.
- Place the food on the broiling rack set in the bake pan as shown in the figure. Place the wire rack (D) in the upper guide (G).
- Always use the broiling rack.
- For easier clean-up, the bake pan can be lined with foil. Be sure not to cover the broiling rack or let foil extend beyond the edges of the pan.
- Turn the meat halfway through cooking.
- Be careful when turning food or removing the pan. Use pot holders and avoid spilling drippings.
- **Never cover heating elements with foil.**
- To top-brown casseroles with cheese toppings, place the dish directly on the wire rack in the upper guide. Close the door and watch carefully to avoid burning the toppings.
- The cooking process can be stopped in any moment by pressing the START/STOP button (9).

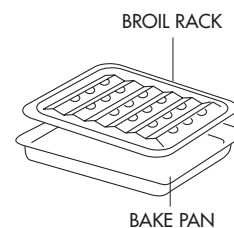

Food	MODE knob	Times	Wire rack position	Comments and tips
Pork chops	BROIL	26 min.	upper	Turn after 14 minutes.
Hot dogs	"	20 min.	"	Turn after 11 minutes.
Hamburgers	"	25 min.	"	Turn after 13 minutes.
Sausages	"	26 min.	"	Turn after 14 minutes.
Kebabs	"	26 min.	"	Turn after 8, 15 and 21 minutes.

2.4 - TOAST MODE

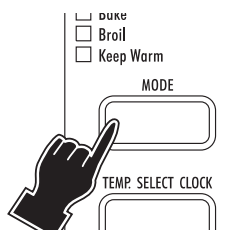

- 1 Press the MODE button (6) until the TOAST indicator light (2) is on.

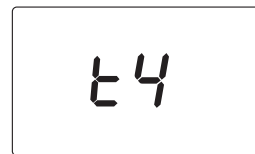

- Toast
- Bake
- Broil
- Keep Warm

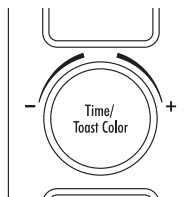

- 2 Set the desired level of toasting by turning the TIME/TOAST COLOR knob (8).

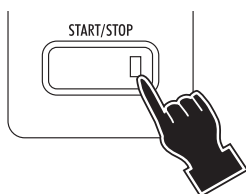
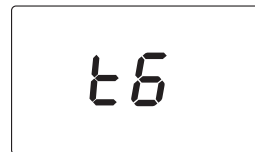

- 3 Press the START/STOP button (9). The display will show the toasting time. At the end of the set time the control will emit 3 "beeps" and the display will return to stand-by (showing the time of the day, if previously set).

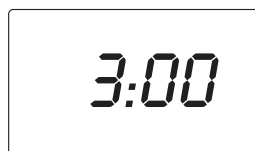

TIPS FOR GOOD RESULTS:

- Place the wire rack (D) in the upper guide (G).
- Place the food to be toasted in the center of the wire rack.
- You have 14 browning selection shades to choose from.
- If the slices are fresh, please select one shade from T1-T2-T3-T4-T5-T6-T7, if the slices are frozen, please select one of the seven "FR" shades (FR T1-FR T2-FR T3-FR T4-FR T5-FR T6-FR T7).
- If the START/STOP button (9) is not pressed within 3 minutes from the previous setting, the control will return to stand-by.
- When toasting, the toasting time will count down on the clock display. The timing will be different for each custom setting you choose. Keep in mind that the timing is adjusted by the oven thermostat. So if your oven is already warm, the toasting time will be less than if you start with a cold oven (the function is automatic).

- When toasting bread, both the top and bottom heating elements are on to toast both sides at the same time.
- Should it be necessary for any reason to suspend the cooking, you only need to press the START/STOP button (9). The display will go back to showing the clock.
- Correct position of the slices according to number.

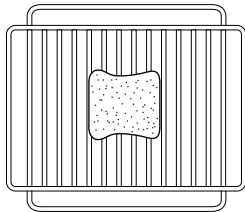

1 slice

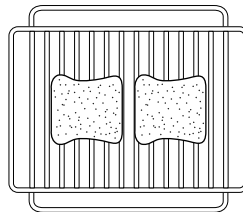

2 slices

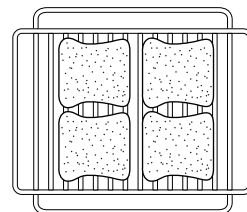

4 slices

2.5 - KEEP WARM MODE

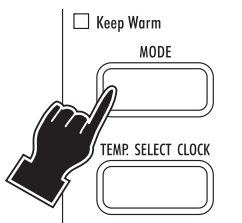

- 1 Press the MODE button (6) until the KEEP WARM indicator light (5) is on and 180°F is displayed.



- Toast
- Bake
- Broil
- Keep Warm

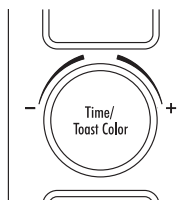

- 2 Select the keep warm time by turning the TIME/TOAST COLOR knob (8).

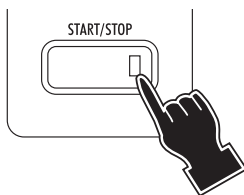
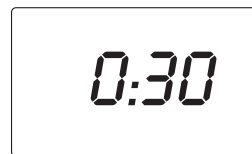

- 3 Press the START/STOP button (9). The oven will start the countdown. At the end of the set time the control will emit 3 "beeps" and the display will return to stand-by (showing the time of the day, if previously set).

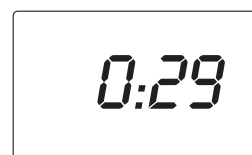

TIPS FOR GOOD RESULTS:

- If the keep warm time is not set (skipping point 2), the display will show the countdown starting from the default duration of 30 minutes.
- If the START/STOP button (9) is not pressed within 3 minutes from the previous setting, the control will return to stand-by.
- It is not possible to change the temperature level.
- It is recommended not to leave the food in the oven for too long, as the food may dry out.
- The cooking process can be stopped in any moment by pressing the START/STOP button (9).

SECTION 3 - CLEANING AND MAINTENANCE

3.1 - CARE AND CLEANING

Frequent cleaning prevents the formation of smoke and bad odors during cooking. Do not let fat accumulate inside the appliance.

Before any maintenance or cleaning operation, unplug the oven and wait for it to cool down.

Clean the door and the exterior surface of the oven with a soap and water solution; dry thoroughly.

To clean the surfaces on the inside of the oven, never use corrosive products and never scrape the walls with sharp objects.

Avoid using abrasive products that may damage the exterior.

Make sure water or liquid soap does not seep into the vents on the top of the oven.

Never immerse the appliance in water.

All the accessories can either be washed by hand or in the dishwasher.

3.2 - CLEANING THE DROP DOWN CRUMB TRAY

To clean the bottom of the oven, pull the crumb tray downwards (see fig. A/B). Place the oven on its rear panel. This will make cleaning easier.

Clean the crumb tray after use to avoid build-up of residue, as this will affect the cooking performance. Brush off crumbs or wipe the crumb tray with a damp cloth. For stubborn stains, use a nylon or plastic scouring pad or a non-caustic cleaner. Dry thoroughly before closing.

After cleaning, close the crumb tray and check that it is locked securely into position.

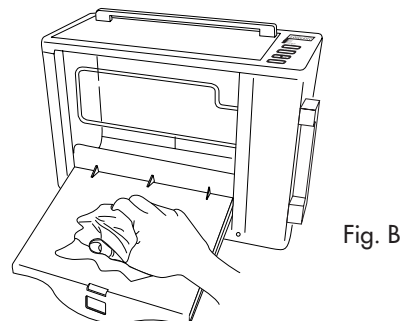
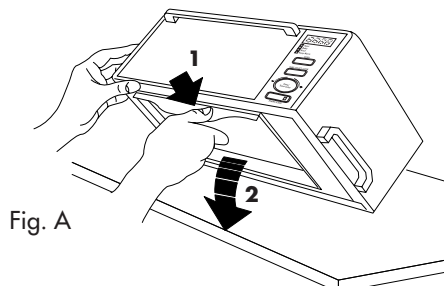

LIMITED WARRANTY

This warranty applies to all products with De'Longhi or Kenwood brand names.

What does the warranty cover?

We warrant each appliance to be free from defects in material and workmanship. Our obligation under this warranty is limited to repair at our factory or authorized service center of any defective parts or part thereof, other than parts damaged in transit. In the event of a products replacement or return, the unit must be returned transportation prepaid. The repaired or new model will be returned at the company expense.

This warranty shall apply only if the appliance is used in accordance with the factory directions, which accompany it, and on an Alternating Current (AC) circuit.

How long does the coverage last?

This warranty runs for one year (1) from the purchase date found on your receipt and applies only to the original purchaser for use.

What is not covered by the warranty?

The warranty does not cover defects or damage of the appliance, which result from repairs or alterations to the appliance outside our factory or authorized service centers, nor shall it apply to any appliance, which has been subject to abuse, misuse, negligence or accidents. Also, consequential and incidental damage resulting from the use of this product or arising out of any breach of contract or breach of this warranty are not recoverable under this warranty. Some states do not allow the exclusion or limitation of incidental or consequential damage, so the above limitation may not apply to you.

How do you get service?

If repairs become necessary, see contact information below:

U.S. Residents:

Please contact our toll free hotline at 1-800-322-3848 or log onto our website at www.delonghi.com.

For all accessories, spare parts or replacement parts, please contact our parts division at 1-800-865-6330.

Residents of Canada: Please contact our toll free hotline at 1-888-335-6644 or log onto our website at www.delonghi.com.

Residents of Mexico: Please refer to the Limited Warranty statement for Mexico.

Please refer to the back page of the manual for De'Longhi addresses.

The above warranty is in lieu of all other express warranties and representations. All implied warranties are limited to the applicable warranty period set forth above. This limitation does not apply if you enter into an extended warranty with De'Longhi. Some states do not allow limitations on how long an implied warranty lasts, so the above exclusions may not apply to you. De'Longhi does not authorize any other person or company to assume for it any liability in connection with the sale or use of its appliance.

How does state law apply?

This warranty gives you specific legal rights, and you may also have other rights, which vary from state to state.