

This Owner's Manual is provided and hosted by [Appliance Factory Parts](#).



DE'LONGHI EO2131 Owner's Manual

[Shop genuine replacement parts for DE'LONGHI
EO2131](#)



[Find Your DE'LONGHI Oven Parts - Select From 110 Models](#)

----- Manual continues below -----

CONTENTS

CHAPTER 1	GENERAL	
1.1	Specifications	11
1.2	Description of the oven and the accessories	12
1.3	Summary of operation	13
1.4	Warnings	14
CHAPTER 2	USE OF THE OVEN AND REFERENCE COOKING TIMES	
2.1	Use of the controls	15
2.2	Tips on use	16
2.3	How to set the functions	16
	• Keeping food warm	16
	• Delicate cooking (if fitted)	16
	• Oven cooking	17
	• Grilling and cooking au gratin	18
	• Grilling with the turnspit (if fitted)	20
CHAPTER 3	CLEANING AND MAINTENANCE	21

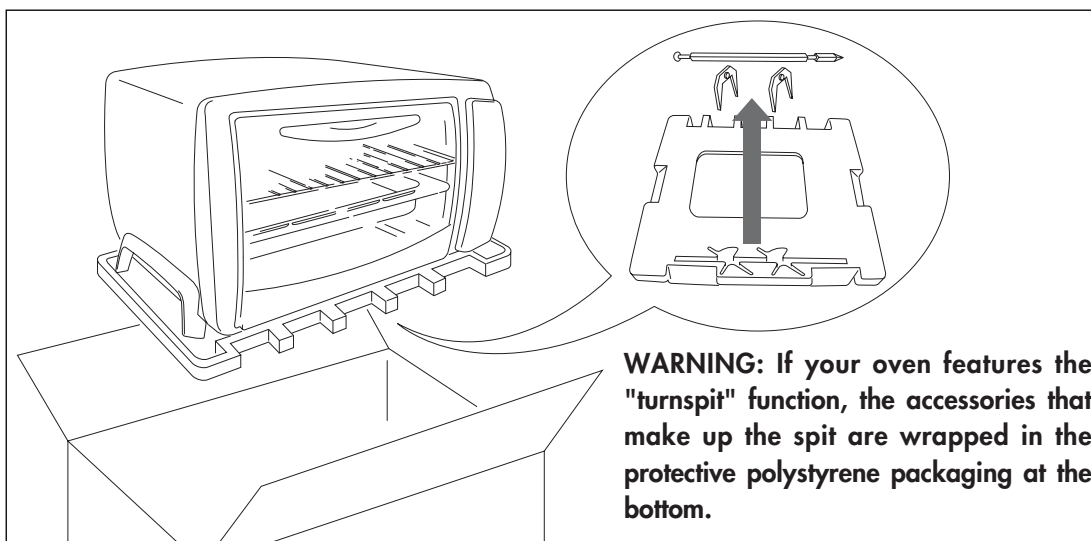

1.1 - SPECIFICATIONS

Operating voltage	see rating plate
Maximum power absorbed	see rating plate
POWER CONSUMPTION (CENELEC STANDARD HD 376)	
To reach 200°C	0,2 kWh
To maintain 200°C for one hour	0,70 kWh
Total	0,90 kWh
This appliance conforms to EC directive 2004/108/EC on Electromagnetic Compatibility and EC regulation no. 1935/2004 of 27/10/2004 on materials intended for contact with food..	

CHAPTER 1 - GENERAL

1.2 - DESCRIPTION OF THE OVEN AND THE ACCESSORIES

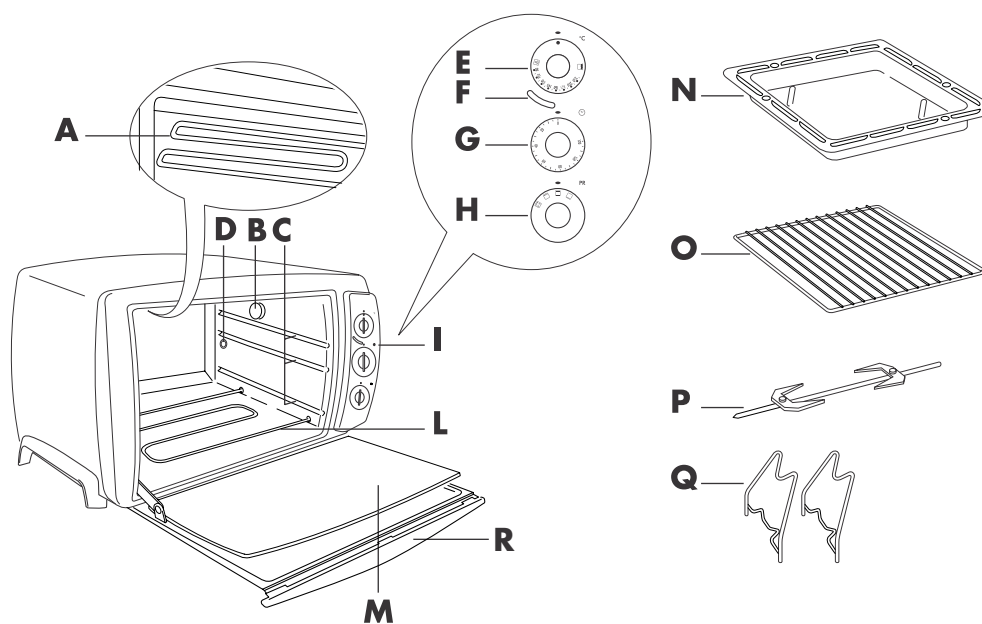





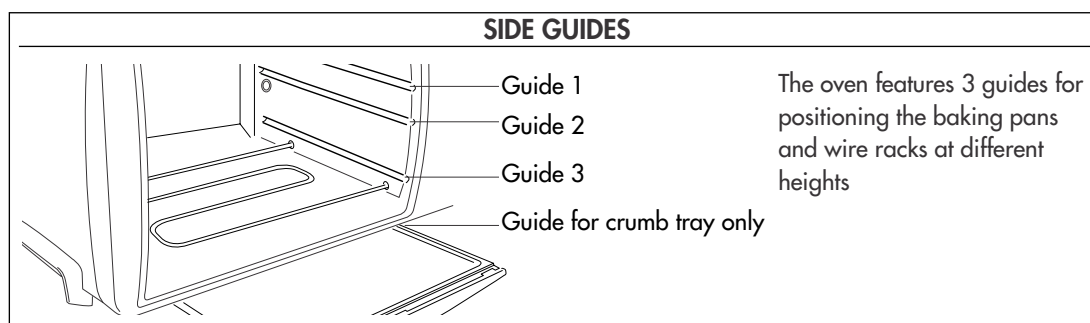





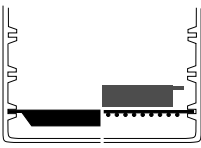

- A** Top heating element
- B** Oven light (if fitted)
- C** Side guides
- D** Turnspit mount (if fitted)
- E** Thermostat knob
- F** Thermostat pilot light
- G** Timer knob (if fitted)
- H** Function selector knob

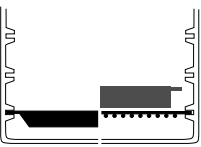
- I** Control panel
- L** Bottom heating element
- M** Glass door
- N** Dripping pan (if supplied)
- O** Wire rack
- P** Spit (if supplied)
- Q** Spit supports (if supplied)
- R** Removable crumb tray

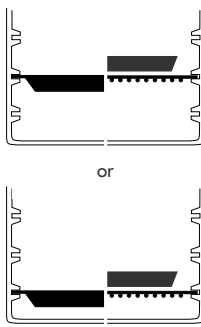

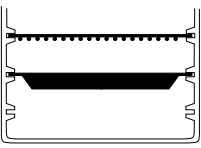
Chapter 1 - General

1.3 - SUMMARY OF OPERATION

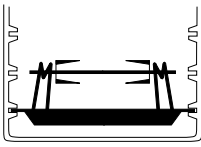
PROGRAM	FUNCTION SELECTOR KNOB SETTING	THERMOSTAT KNOB SETTING	POSITION OF WIRE RACK AND ACCESSORIES	GUIDES	NOTES/TIPS
KEEPING FOOD WARM				1 2 3	If the food needs to be kept warm for longer than 20-30 minutes, it should be covered with tinfoil, to prevent it from becoming too dry.
DELICATE COOKING (IF FITTED)		80°- 230°		1 2 3	Use the dripping pan, sliding it directly into the lower guide, or a baking pan on the wire rack (in the lower guide)
OVEN COOKING		80°-230° (see table on page 17)		1 2 3 1 2 3	Use the dripping pan, sliding it directly into the guides, or a baking pan placed directly on the wire rack.
GRILLING AND COOKING AU GRATIN				1 2 3	Ideal for all types of traditional grill; hamburgers, frankfurters, kebabs, toast, etc. Place the food directly on the wire rack. The dripping pan is used to collect any drops of fat.
				1 2 3	Ideal for dishes that need to be cooked au gratin (e.g. coquilles Saint-Jacques, etc.). In this case, the container (with the food inside) should be placed on the wire rack.
GRILLING WITH THE TURNSPIT (IF FITTED)				1 2 3	Ideal for cooking chickens, fowl in general, roast pork, etc. A glass of water can be poured into the dripping pan to make cleaning easier and prevent smoke being produced by the burning fat.

1.4 - WARNINGS

- **Read all the instructions carefully before using the appliance.**
- This oven has been designed to cook food. It must never be used for other purposes, modified or tampered with in any way.
- Place the appliance on a horizontal surface at a height of at least 85 cm and out of reach of children.
- Wash all accessories thoroughly before use.
- **Before plugging into the mains, make sure that:**
 - the mains voltage corresponds to the voltage indicated on the rating plate;
 - the mains socket has a minimum rating of 16A and an earth wire.
- **The manufacturer declines all liability in the event that this important accident-prevention rule is not respected.**
- Before using the oven for the first time, remove any paper and other material inside the oven such as protective cardboard, booklets, plastic bags, etc.
- Before using for the first time, operate the oven empty with the thermostat at maximum for at least 15 minutes to eliminate the "new" smell and any smoke caused by the presence of protective substances applied to the elements before transport. During this operation, ventilate the room.

IMPORTANT: when you have unpacked the appliance, make sure the door is undamaged and working correctly. The door is made from glass and is therefore fragile. If it is visibly chipped, scored or scratched, it should be replaced. While using, cleaning or moving the appliance, avoid slamming or knocking the door violently. Do not pour cold liquid onto the glass while the appliance is hot.

- Do not use harsh abrasive cleaners or sharp metal scrapers to clean the oven door glass since they can scratch the surface, which may result in shattering of the glass
- **When in operation, the door and accessible external surfaces could become very hot. Always use the knobs, handles and buttons. Never touch metal parts or the glass. Use oven gloves if necessary.**
- **This electrical appliance operates at high temperatures which could cause burns.**
- The appliance is not intended for use by persons (including children) with reduced physical, sensory or mental capabilities, or lack of experience and knowledge, unless they have been given supervision or instruction concerning use of the appliance by a person responsible for their safety. Children should be supervised to ensure that they do not play with the appliance.
- Do not move the appliance while in use.
- Do not use the appliance if...
 - the power cable is faulty,
 - the appliance has been dropped, is visibly damaged or malfunctions.Should this occur, to avoid all risk take the appliance to your nearest authorised service centre.
- Do not let the power cable dangle and avoid touching hot parts of the oven. Never unplug the appliance by pulling on the power cable.
- If you intend to use an extension, make sure it is in good condition, that the plug is earthed and that the cross section of the wires is at least equal to that of the power cable provided with the appliance.
- To avoid all risk of electric shock, never immerse the power cable, plug or appliance itself in water.
- Never position the appliance near heat sources.
- Do not leave inflammable products near the oven or under the work surface where it is located.
- Bread may burn. Never leave the oven unattended during toasting or grilling. Never operate the appliance under a wall cupboard or shelf or near inflammable materials such as curtains, blinds, etc.
- Do not use the appliance as a heat source.
- Never place paper, cardboard or plastic inside the oven and never rest anything on top of the appliance (utensils, wire racks, other objects).
- Never insert anything into the ventilation openings. Make sure they are unobstructed.
- **If food or other parts of the oven catch fire, never try and put out the flames with water. Close the door, unplug from the mains and smother the flames with a damp cloth.**
- This oven is not designed for built-in installation.
- When the door is open, remember:
 - never exert excessive pressure with overly heavy objects or pull the handle downwards;
 - never rest heavy containers or boiling saucepans just out of the oven on the open door.
- Given the differences in legislation in force, if the appliance is used in a country other than that where it was bought, have it checked by an authorised service centre.
- For your personal safety, never take the appliance to pieces on your own. Always contact an authorised service centre.
- This appliance is designed for domestic use only. Professional or inappropriate use, or failure to observe the instructions absolves the manufacturer from all responsibility and invalidates the guarantee.
- When not in use and before cleaning, always unplug the appliance.
- If the supply cord is damaged, it must be replaced by the manufacturer or its service agent or a similarly qualified person in order to avoid a hazard.

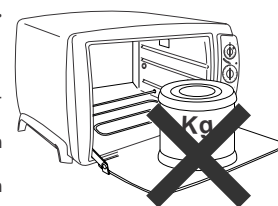



Keep these instructions

CHAPTER 2 - USE OF THE OVEN AND REFERENCE COOKING TIMES

2.1 - USE OF THE CONTROLS

- **THERMOSTAT KNOB (E)**

Select the desired temperature as follows

- **Keeping food warm:** Thermostat knob set to .
- **Oven cooking:** Thermostat knob set from 80°C to 230°C.
- **All types of grilling and cooking with the turnspit (if fitted):** Thermostat knob in position .

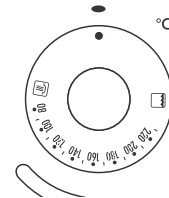

- **TIMER KNOB (IF FITTED) (G)**

- **To set the cooking time:** Turn the knob clockwise to the desired time (max. 120 minutes). A bell will ring when the set time has elapsed, and the oven will automatically switch itself off.
- **To switch the oven off:** Turn the knob to position "0".

When setting times of less than 10 minutes, first turn the knob all the way round, and then set the desired time.

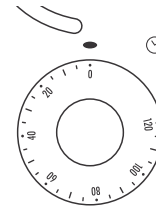

- **FUNCTION SELECTOR KNOB (H)**

This knob is used to select from the available cooking functions, as follows:

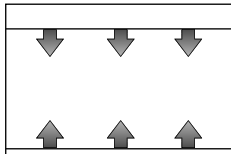
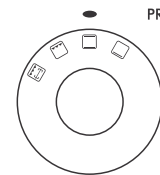

 **OVEN COOKING AND KEEPING FOOD WARM**

(top heating element and bottom heating element on only)

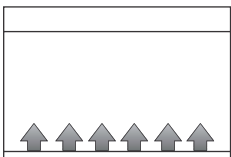

 **DELICATE COOKING (IF FITTED)**

(lower heating element only operating)

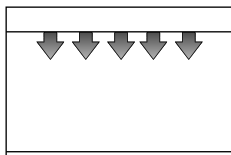

 **GRILLING**

 **TURNSPIT (IF FITTED)**

(top heating element on only, at maximum power)

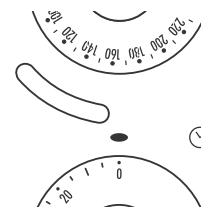

- **THERMOSTAT PILOT LIGHT (F)**

The light comes on to indicate that the oven is heating up, and goes off when the oven has reached the set temperature.

2.2 - GENERAL ADVICE

- For oven cooking and “delicate” cooking, for best results the oven should always be preheated to the desired temperature.
- The cooking times depend on the quality of the products, the temperature of the food and individual tastes. The times given in the table are only intended as a guide, and may need to be varied. They do not take into account the time required to preheat the oven.
- When cooking frozen food, follow the recommendations on the package.

2.3 - HOW TO SET THE FUNCTIONS

- **KEEPING FOOD WARM** 

Place the dripping pan or the wire rack with a pan on top in guide no. 3, as shown in the figure on page 15. This function is used to keep the food warm until serving. The food should not be left in the oven too long, as it may become too dry (to avoid this, cover the pan with tinfoil or baking paper).

Turn the function selector knob (H) to position .

Turn the thermostat knob (E) to .

Turn the Timer knob (if fitted) (G) to the time desired. A bell will ring when the set time has elapsed; if the food being kept warm is served before the end of the set time, manually turn the Timer knob (if fitted) (G) to position “0”.

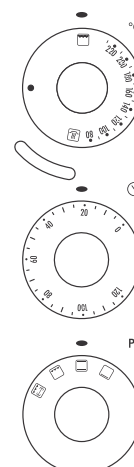

- **DELICATE COOKING (IF FITTED)** 

Place the dripping pan or the wire rack with a pan on top in guide 3, as shown in the figure on page 13. Ideal for pastries and cakes with icing. Good results are also achieved when completing the cooking of the base of foods or for cooking that requires heat above all at the bottom. The baking pan should be inserted in the lower guide (3).

Turn the function selector knob (H) to position .

Select the desired temperature using the thermostat knob (E).

Turn the Timer knob (if fitted) (G) to the time desired. A bell will ring when the set time has elapsed; if the food being kept warm is served before the end of the set time, manually turn the Timer knob (if fitted) (G) to position “0”.

Chapter 2 - Use of the oven and reference cooking times

• OVEN COOKING

Turn the function selector knob (H) to position .

Select the desired temperature using the thermostat knob (E).

Turn the Timer knob (if fitted) (G) to the time desired.

Wait for the oven to reach the set temperature (the pilot light goes off), then place the dish containing the food on the wire rack (previously placed in the oven), or, if the food is in the dripping pan, place the pan directly into the guide (refer carefully to the table below). A bell will ring when the set time has elapsed.

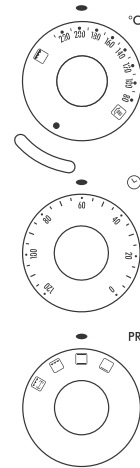

RECIPE	QUANTITY	THERMOSTAT KNOB	TIME	WIRE RACK/DRIPPING PAN POSITION	OBSERVATIONS AND TIPS
FRESH PIZZA	400 g	200°C	25 min.	3	Rest the dripping pan (N) or a tray on the wire rack (O)
SAVOURY PIE	600 g	200°C	35 min.	3	Use the dripping pan (N) or a cake tin on the wire rack
FROZEN PIZZA	450 g	220°C	13 min.	2	Can be placed directly on the wire rack (O) or on the dripping pan (N)
LASAGNE	1500 g	200°C	40 min.	3	Place the baking pan directly on the wire rack (O)
CANNELONI	2300 g	200°C	40 min.	3	Place the baking pan directly on the wire rack (O)
WHOLE CHICKEN	1500 g	220°C	90 min.	3	Pierce with a fork to drain the fat
ROAST PORK	1500 g	220°C	90 min.	3	Leave a little fat around the edges to prevent it from becoming too dry
MEAT LOAF	1000 g	200°C	60 min.	3	Place it directly on the dripping pan (N) or in a pan resting on the wire rack (O)
RABBIT PIECES	1000 g	200°C	60 min.	3	Add a little water. If necessary, turn half way through cooking.
SEA BASS IN SALT	900 g	190°C	40 min.	3	Cover the fish completely with rock salt.
BAKED BREAM	1000 g	190°C	40 min.	3	These can be cooked directly on the dripping pan (N) or in a pan resting on the wire rack (O)
TROUT BAKED IN FOIL	800 g	190°C	40 min.	3	These can be cooked directly on the dripping pan (N) or in a pan resting on the wire rack (O), wrapped in tinfoil
AUBERGINES WITH PARMESAN	1700 g	200°C	30 min.	2	Place the baking pan on the wire rack (O)
COURGETTES WITH TUNA	1000 g	200°C	40 min.	2	Rest the dripping pan (N) or a pan on the wire rack (O): add oil, tomato and water
POTATOES AU GRATIN	1500 g	200°C	40 min.	2	Place the baking pan on the wire rack (O)
APPLE PIE	1000 g	190°C	90 min.	3	Place the cake tin on the wire rack (O)
MUFFINS	600 g	200°C	18 min.	2	Place the muffin cups directly on the dripping pan

Add around 5 minutes to the cooking time for preheating.

Chapter 2 - Use of the oven and reference cooking times

• GRILLING AND COOKING AU GRATIN

This function is ideal for grilling hamburgers, chops, frankfurters, sausages, etc. In addition, this function may be used for browning foods: gnocchi alla romana, coquilles Saint-Jacques, etc..

Operate as follows:

Place the food being grilled directly on the wire rack and the dripping pan (N) in the centre guide (2) as shown in Figure 1. Leave the door ajar as shown in Figure 2. Pour a glass of water into the dripping pan (N) to make cleaning easier and prevent smoke being produced by the burning fat.

Turn the function selector knob (H) to position .

Turn the thermostat knob (E) to position .

Turn the Timer knob (if fitted) (G) to the time desired.

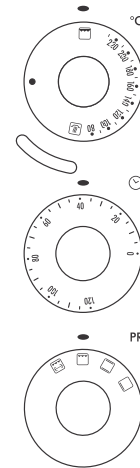

Important: for best results, place the food on the wire rack (O), leaving an empty space of around 2cm near the door (see Figure 1).

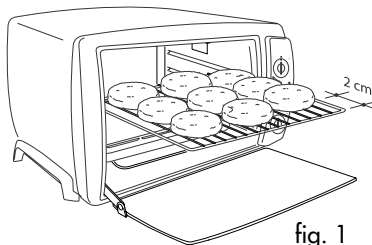

fig. 1

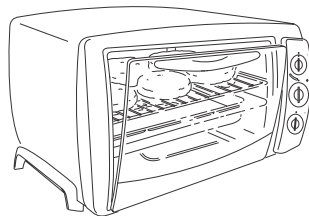

fig. 2

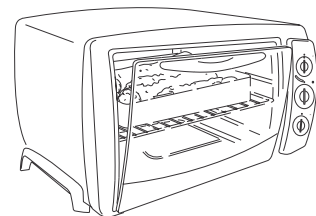
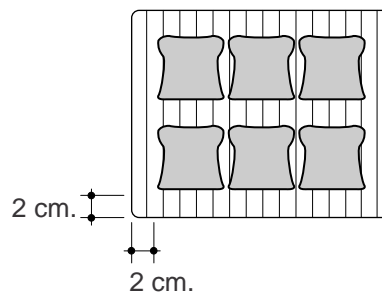

fig. 3

In the case of food that has already been cooked or is to be cooked au gratin, place the container directly on the wire rack in the centre guide (2); the door must be left ajar as shown in Figure 3. A bell will ring when the set cooking time has elapsed; if cooking is completed before the end of the set time, manually turn the Timer knob (if fitted) (G) to position "0".

Chapter 2 - Use of the oven and reference cooking times

To correctly toast bread, place the slices as shown in the figure to the side, that is, leaving 2cm of free space at the ends of the wire rack.



FOR TOASTING BREAD ONLY: preheat the oven for 2-3 minutes with the door ajar (as shown in the figure 4)

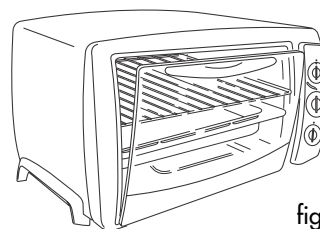

fig. 4

The table below provides some useful tips for preparing great grilled food.

RECIPE	QUANTITY	THERMOSTAT KNOB	TIME	OBSERVATIONS AND TIPS
PORK CHOPS (4)	600 g		20 min.	Turn after approx. 12 minutes
SAUSAGES (12)	1200 g		25 min.	Pierce with a fork to drain the fat. Turn after approx. 15 minutes
HAMBURGERS (6)	700 g		20 min.	Turn after approx. 12 minutes
FRANKFURTERS (6)	500 g		10 min.	Turn after approx. 3-4 minutes
KEBABS (4)	650 g		25 min.	Turn after approx. 15 minutes
TOAST	6 slices		3,5 min.	Turn half way through toasting.
GNOCCHI ROMANA	ALLA 1500 g		15 min.	Place the baking pan on the wire rack, positioned in the centre guide (2)

Chapter 2 - Use of the oven and reference cooking times

• GRILLING WITH THE TURNSPIT (IF FITTED)

This function is ideal for cooking chickens on the spit, fowl in general, roast pork and veal.

Operate as follows:

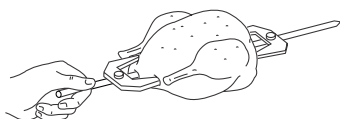

fig. 5

Place the food on the spit (P) and hold it firm using the forks (for best results, tie the meat using kitchen string).

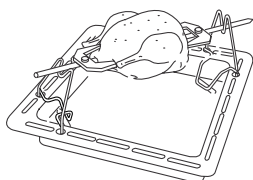

fig. 7

Place the spit on the supports.

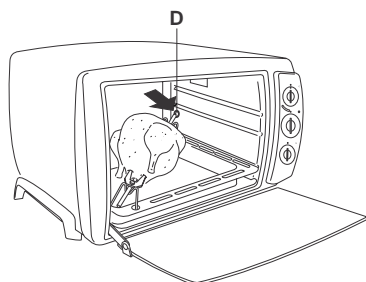

fig. 9

Once the dripping pan is in place, push the spit into the turnspit mount (D), tilting the spit supports (Q) to the right.

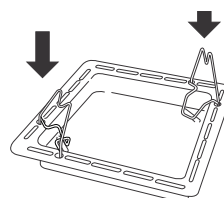

fig. 6

Place the spit supports (Q) on the dripping pan, in the holes provided.

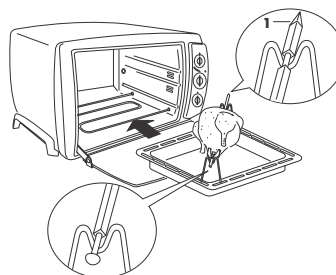

fig. 8

Place the dripping pan with the food being cooked in the lower guide (3), tilting the spit supports (Q) to the left. Make sure that the tip of the spit 1 is facing forwards.

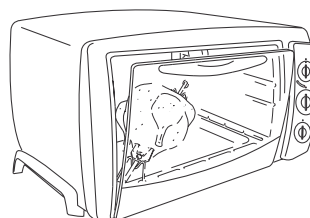



fig. 10

Close the door, leaving it slightly ajar, as highlighted in the figure (half-open).

The oven does not need to be preheated for this function.

Turn the function selector knob (H) to position .

Turn the thermostat knob (E) to position .

Turn the Timer knob (if fitted) (G) to the time desired.

If the cooking time is longer than 2 hours, remember to reset the timer.

Once cooking is complete, manually turn the Timer knob (if fitted) (G) to position "0".



CHAPTER 3 - CLEANING AND MAINTENANCE

Frequent cleaning will prevent the formation of smoke and bad smells during cooking. **Before performing any cleaning operations, always unplug the appliance from the power socket.** Never immerse the appliance in water; do not wash it by spraying it with water (fig. 11). The wire rack, dripping pan, and spit (if supplied) are washed like normal dishes, by hand or in the dishwasher. Always use a damp sponge to clean the outer surface. Avoid using abrasive products that may damage the surface finish (enamel or paint). Make sure water or liquid soap does not infiltrate through the slits on the right-hand side of the oven. To clean the inside of the oven, never use corrosive products and do not scrape the walls with sharp objects or blades. Only use non-abrasive liquid detergents. Do not attempt to push forks, knives or sharp objects into the openings on the right-hand side and the rear of the oven.

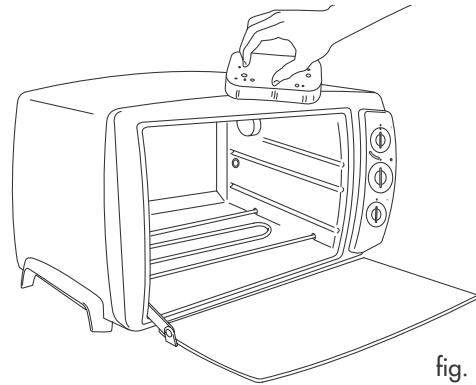

fig. 11

OVEN LIGHT

The oven light (B) is always on when the oven is on. To replace the bulb, proceed as follows:

- unplug the appliance from the power socket
- unscrew the protective glass cover (X), by turning it anti-clockwise, and replace the bulb (Y) with a new one of the same type (see fig. 12). Replace the protective glass cover (X).

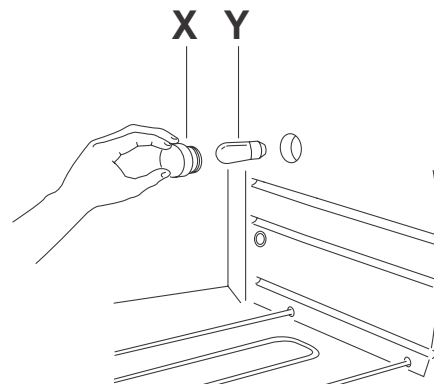

fig. 12

Only use bulbs suitable for ovens (T300°C)

N.B. The oven can still be used even if the bulb is burnt-out

IMPORTANT INFORMATION FOR CORRECT DISPOSAL OF THE PRODUCT IN ACCORDANCE WITH EC DIRECTIVE 2002/96/EC.

At the end of its working life, the product must not be disposed of as urban waste. It must be taken to a special local authority differentiated waste collection centre or to a dealer providing this service. Disposing of a household appliance separately avoids possible negative consequences for the environment and health deriving from inappropriate disposal and enables the constituent materials to be recovered to obtain significant savings in energy and resources. As a reminder of the need to dispose of household appliances separately, the product is marked with a crossed-out wheeled dustbin.



ELECTRICAL CONNECTION (UK ONLY)

A) If your appliance comes fitted with a plug, it will incorporate a 13 Amp fuse. If it does not fit your socket, the plug should be cut off from the mains lead, and an appropriate plug fitted, as below.

WARNING: Very carefully dispose of the cut off plug after removing the fuse: do not insert in a 13 Amp socket elsewhere in the house as this could cause a shock hazard.

With alternative plugs not incorporating a fuse, the circuit must be protected by a 15 Amp fuse. If the plug is a moulded-on type, the fuse cover must be re-fitted when changing the fuse using a 13 Amp Asta approved fuse to BS 1362. In the event of losing the fuse cover, the plug must NOT be used until a replacement fuse

Green and yellow:	Earth
Blue:	Neutral
Brown:	Live



As the colours of the wires in the mains lead may not correspond with the coloured markings identifying the terminals in your plug, proceed as follows:

cover can be obtained from your nearest electrical dealer. The colour of the correct replacement fuse cover is that as marked on the base of the plug.

B) If your appliance is not fitted with a plug, please follow the instructions provided below:

**WARNING - THIS APPLIANCE MUST BE EARTHED
IMPORTANT**

The wires in the mains lead are coloured in accordance with the following code:

The green and yellow wire must be connected to the terminal in the plug marked with the letter E or the earth symbol \equiv or coloured green or green and yellow.

The blue wire must be connected to the terminal marked with the letter N or coloured black.

The brown wire must be connected to the terminal marked with the letter L or coloured red.