

This Owner's Manual is provided and hosted by [Appliance Factory Parts](#).



DE'LONGHI ESAM4500 Owner's Manual

[Shop genuine replacement parts for DE'LONGHI
ESAM4500](#)



[Find Your DE'LONGHI Coffee Maker Parts - Select From 289 Models](#)

----- Manual continues below -----



De'Longhi America, Inc.
Park 80 West, Plaza One
Saddle Brook, NJ 07663
#1-866-Latte-Best
1-866-528-8323

De'Longhi Canada, Inc.
6150 McLaughlin Road
Mississauga, Ontario
L5R 4E1 Canada
#1-866-Latte-Best
1-866-528-8323

FIDUCIA ITALIANA S.A DE C.V
Pestalozzi #814
Col. Narvarte
Del. Benito Juarez
C.P. 03100
tels: 5543 1447
lada sin costo: 01 800 711 8805

www.delonghi.com



**IMPORTANT INSTRUCTIONS
SAVE THESE INSTRUCTIONS**

**MODE D'EMPLOI IMPORTANT
CONSERVEZ LES PRESENTES INSTRUCTIONS**

**INSTRUCCIONES IMPORTANTES
LEA CUIDADOSAMENTE ESTE INSTRUCTIVO ANTES DE USAR SU APARATO
REPASE Y GUARDE ESTAS INSTRUCCIONES**

**ISTRUZIONI IMPORTANTI
CONSERVARE LE ISTRUZIONI**



**COFFEE MAKER TYPE EAM4500/CAFETERIE MODÈLE EAM4500/
CAFETERA ELECTRICA MODELO EAM4500/ MACCHINA DA CAFFÈ EAM4500**

Register this product on-line and receive a free trial issue of Cook's Illustrated. Visit www.prodregister.com/delonghi.
Visit www.delonghi.com for a list of service centers near you. (U.S. and Canada only)

Enregistrez ce produit en ligne et recevez un numéro gratuit de Cook's Illustrated. Visitez www.prodregister.com/delonghi.
Visitez www.delonghi.com pour y voir une liste des centres de réparation proches de chez vous. (É.-U. et Canada seulement).

Registre este producto en línea y reciba un ejemplar gratis de Cook's Illustrated. Visite www.prodregister.com/delonghi.
Visite www.delonghi.com para ver la lista de centros de servicios cercanos a usted. (solo Estados Unidos y Canada)

Registra questo prodotto "on-line" per ricevere una copia omaggio della rivista. Visita www.prodregister.com/delonghi.
Visita www.delonghi.com per una lista dei centri di servizio a te più vicini. (solo Stati Uniti e Canada)

**ELECTRONIC CHARACTERISTICS: CARACTÉRISTIQUES ÉLECTRIQUES: CARACTERISTICAS ELECTRICAS:
CARATTERISTICHE ELETTRICHE: 120V-60Hz 1 100W**

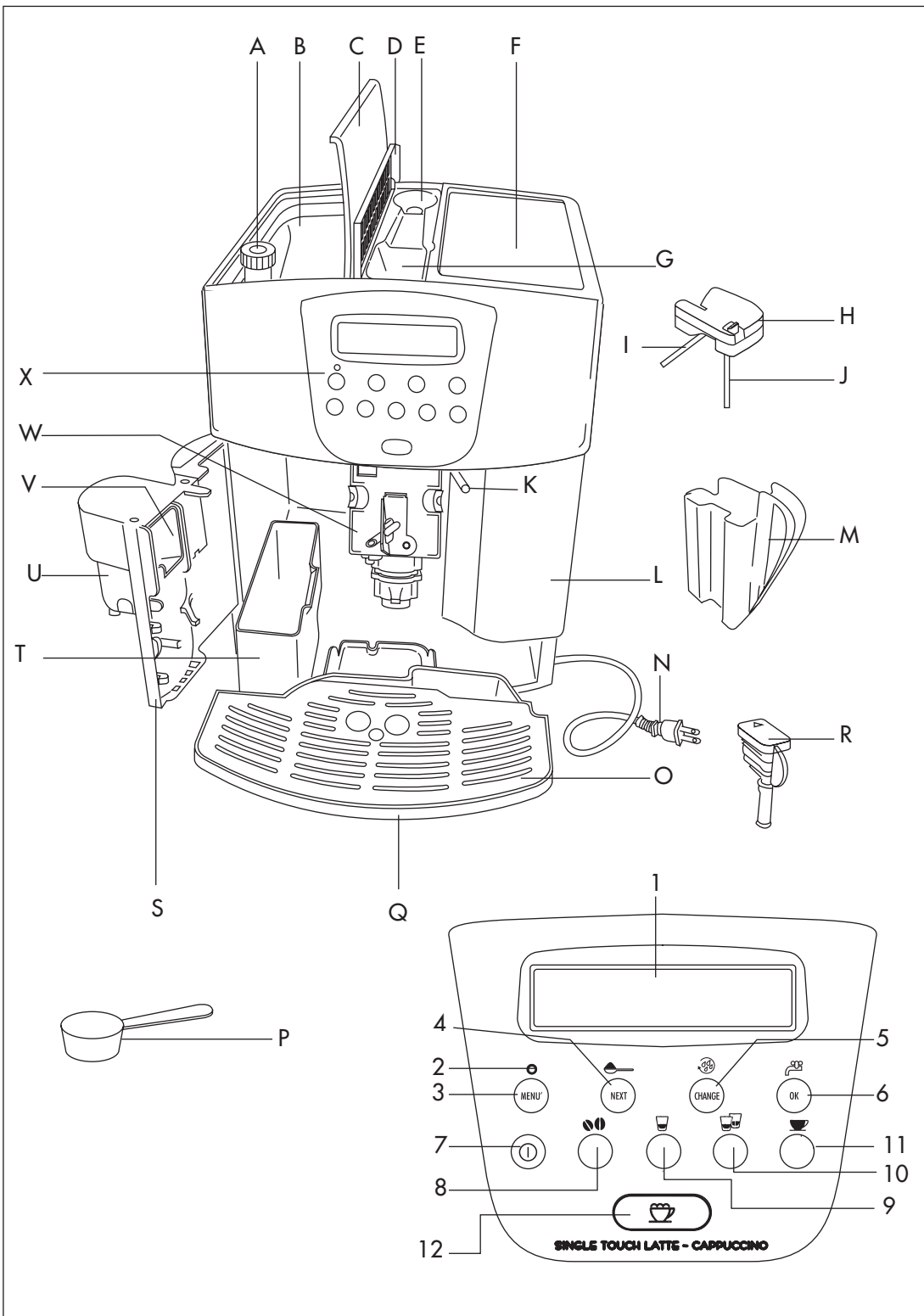

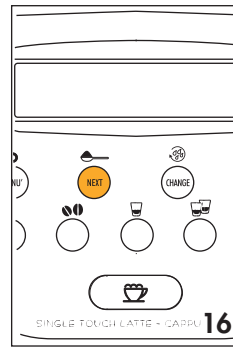
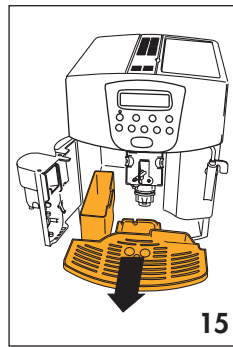
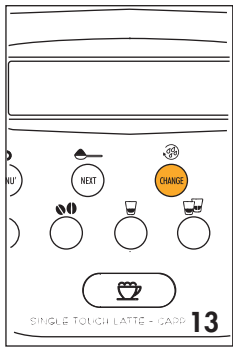
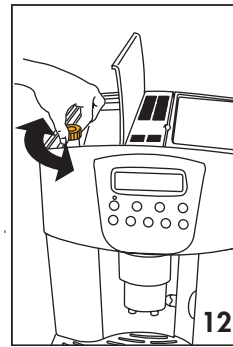
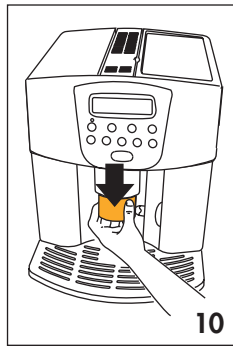
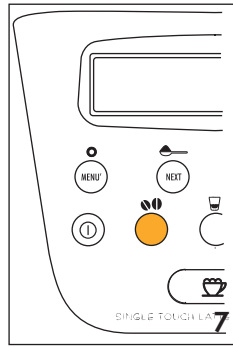
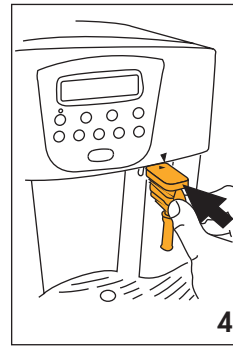
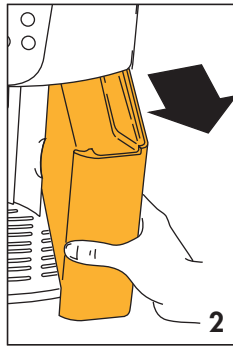
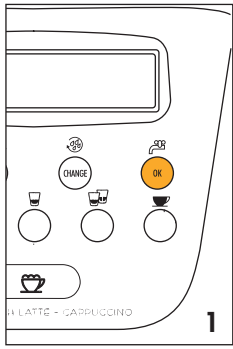

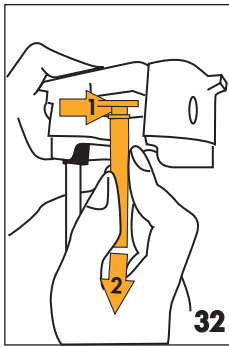
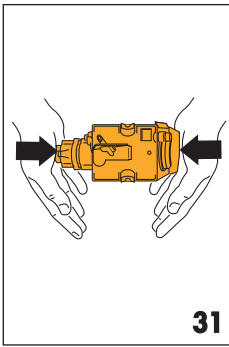
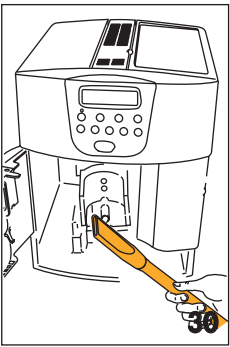
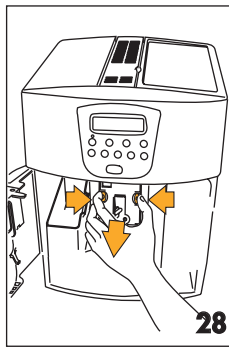
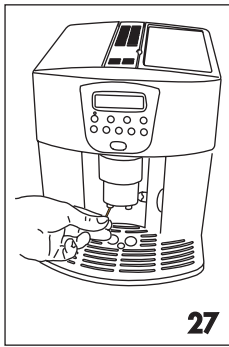
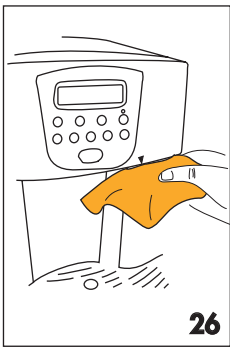
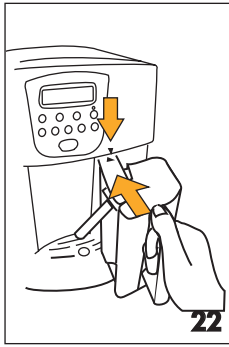
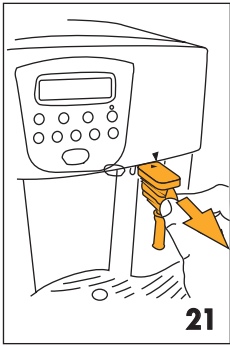
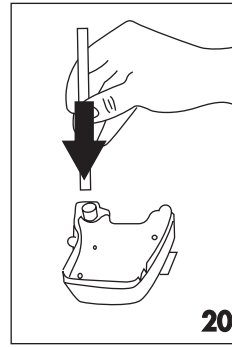
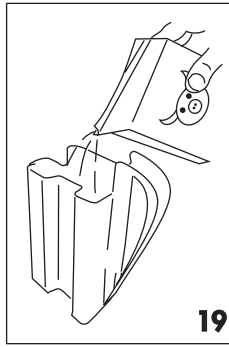
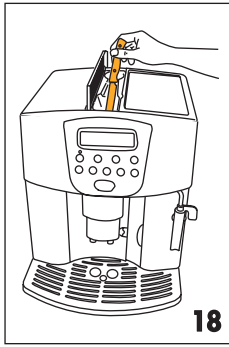
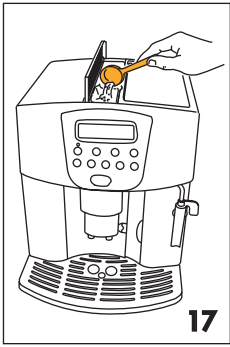

Coffee has been used to factory test the appliance and it is therefore completely normal for there to be traces of coffee in the mill. This appliance is however guaranteed to be new.

INDEX

IMPORTANT SAFEGUARDS	.7
1 DESCRIPTION (see page 3)	.8
2 SAFETY WARNINGS	.8
3 INSTALLATION	.9
4 USING FOR THE FIRST TIME	.9
5 TURNING ON AND PREHEATING	.10
6 PREPARING COFFEE (USING COFFEE BEANS)	.10
7 CHANGING THE QUANTITY OF COFFEE IN THE CUP	.12
8 REGULATING THE COFFEE MILL	.12
9 PREPARING ESPRESSO COFFEE USING GROUND COFFEE (INSTEAD OF BEANS)	.13
10 PRODUCING HOT WATER	.13
11 CHANGING THE QUANTITY OF HOT WATER	.14
12 PREPARING LATTE OR CAPPUCCINOS (MILK WITH COFFEE)	.14
13 PREPARING STEAMED OR FROTHED MILK (WITHOUT COFFEE)	.15
14 CHANGING THE QUANTITY OF COFFEE AND MILK FOR LATTES OR CAPPUCCINOS	.15
15 CLEANING AND MAINTENANCE	.16
15.1 CLEANING THE COFFEE MAKER	.16
15.2 CLEANING THE INFUSER	.16
15.3 CLEANING THE MILK CONTAINER	.17
16 CHANGING AND SETTING THE MENU PARAMETERS	.17
16.1 SETTING THE CLOCK	.18
16.2 SETTING AUTO-START TIME	.18
16.3 DESCALING	.18
16.4 CHANGING COFFEE TEMPERATURE	.19
16.5 CHANGING THE LENGTH OF TIME THE APPLIANCE REMAINS ON	.19
16.6 SETTING WATER HARDNESS	.20
16.7 RESETTING FACTORY DEFAULT SETTINGS	.20
17 CHANGING THE LANGUAGE	.20
18 TROUBLESHOOTING	.21
19 PROBLEMS TO BE RESOLVED BEFORE CALLING THE SERVICE CENTER	.22
LIMITED WARRANTY	.24

IMPORTANT SAFEGUARDS

When using electrical appliances, basic safety precautions should always be followed, including the following:

- Read all instructions.
- Do not touch hot surfaces. Use handles and knobs.
- To protect against fire, electrical shock and personal injury, do not immerse cord, plug or appliance in water or other liquid.
- Never allow the appliance to be used by children.
- Unplug from the outlet when not in use and before cleaning. Allow to cool before fitting or taking off parts, and before cleaning the appliance.
- Do not operate with a damaged cord or plug, or after the appliance malfunctions, or has been damaged in any manner. Return the appliance to the nearest authorized service facility for examination, repair or adjustment.
- The use of accessory attachments or spare parts not recommended by the appliance manufacturer may result in fire, electrical shock or personal injury.
- Do not use outdoors.
- Do not let the cord hang over the edge of the table or counter, or touch hot surfaces.
- Do not place on or near a hot gas or electrical burner, or in a heated oven.
- Plug cord into the wall outlet. To disconnect, turn any control to "off", then remove plug from wall outlet.
- Do not use the appliance for other than the intended use. This appliance is to be utilized for domestic use only. Any other use is to be considered improper and therefore, dangerous.

WARNING: To reduce the risk of fire or electric shock, do not remove the cover.

No user serviceable parts inside. Repair should be done by authorized service personnel only!

SAVE THESE INSTRUCTIONS

THIS PRODUCT IS FOR HOUSEHOLD USE ONLY

SHORT CORD INSTRUCTIONS

- A short power cord is provided to reduce risks resulting from becoming entangled in or tripping over a longer cord.
- Longer, detachable power supply cords or extension cords are available and may be used if care is exercised in their use.
- If an extension cord is used, the marked electrical rating should be at least as great as the electrical rating of the appliance. If the appliance is provided with 3- wire, grounding type cord, the extension should be a GROUNDING TYPE 3 - WIRE CORD. The longer cord should be arranged so that it will not drape over the counter-top or table top where it can be pulled on by children or tripped over.
- Your product is equipped with a polarized alternating current line plug (a plug having one blade wider than the other). This plug will fit into the power outlet only one way. This is a safety feature. If you are unable to insert the plug fully into the outlet, try reversing the plug. If the plug should still fail to fit, contact your electrician to replace your obsolete outlet. Do not defeat the safety purpose of the polarized plug.

1 DESCRIPTION (SEE PAGE 3)

- A. Grinding coarseness regulator
- B. Coffee bean container
- C. Bean container lid
- D. Central lid for ground coffee
- E. Compartment for measuring scoop
- F. Cup warmer tray
- G. Ground coffee funnel
- H. Milk container lid with milk froth regulator
- I. Milk spout
- J. Milk intake tube
- K. Nozzle
- L. Water tank (removable)
- M. Milk container
- N. Power cable
- O. Cup tray
- P. Measuring scoop for pre-ground coffee
- Q. Drip tray (removable)
- R. Hot water spout
- S. Service door
- T. Coffee grounds container (removable)
- U. Coffee spout (adjustable in height)
- V. Mobile drawer
- W. Infuser
- X. Control panel

Control Panel

1. Display
2. MENU light
3. Button to activate or deactivate menu parameter setting mode;
4. Button to select ground coffee or, if the MENU light is on, to display the next parameter on the menu;
5. Button to rinse the appliance or, if the MENU light is on, to change the menu parameters;
6. Button to select hot water or, if the MENU light is on, to confirm the menu parameters;
7. Appliance ON/OFF button;
8. Coffee strength selection button;
9. One shot espresso button;
10. Two shots espresso button;
11. One long shot button;
12. Single Touch Latte - Cappuccino button

2 SAFETY WARNINGS

READ THESE INSTRUCTIONS CAREFULLY AND KEEP FOR FUTURE CONSULTATION!

- This appliance is designed to "make espresso coffee" and "hot drinks". Use with care to avoid scalds from the water and steam jets or through incorrect use.
- This appliance is intended for domestic use only. Any other use is considered improper and thus dangerous.
- The manufacturer is not liable for damage caused by improper, incorrect or unreasonable use of the appliance.
- When using the appliance, do not touch the hot surfaces.
- Do not touch the appliance with damp hands or feet.
- Do not allow children or infirmed persons to use the appliance unsupervised.
- Never allow children to play with the appliance.
- In the event of failure or malfunction, unplug the appliance from the outlet and do not tamper with it in any way. If it requires repair, contact an authorized service center only and ask for original spare parts to be used. Failure to respect the above could reduce the safety of the appliance.

3 INSTALLATION

- After removing the packaging, make sure the product is complete and undamaged. If in doubt, do not use the appliance and contact a qualified professional.
- Packing elements (plastic bags, polystyrene etc) must not be left within reach of children as they may represent a hazard.
- Place the appliance on a work surface far away from water taps, basins and sources of heat.
- After positioning the appliance on the work top, leave a space of at least 2 in (5 cm) between the surfaces of the appliance and the side and rear walls and at least 8 in (20 cm) above the coffee maker.
- Never install the appliance in environments where the temperature may reach freezing or below freezing temperatures (the appliance could be damaged if the water freezes).
- Connect the appliance to a grounded socket with a minimum current rating of 10amps. The manufacturer is not liable for possible accidents caused by failure to do so.
- If the power socket does not match the plug on the appliance, have the socket replaced with a suitable type by a qualified professional.
- The power cable on this appliance must not be replaced by the user as this operation requires the use of special tools. If the cable is damaged or requires replacing, contact an authorized service center only to avoid all risks.
- You should personalize water hardness as soon as possible following the instructions in section 16.6.

To learn how to operate the appliance correctly, when you use it for the first time, follow the step-by-step instructions given in the following paragraphs.

4 USING FOR THE FIRST TIME

1. The first time you use the appliance, select the language.

To set English, plug the appliance into the outlet and wait for the appliance to display:

PRESS OK TO SELECT ENGLISH

Press the **OK** button (fig. 1) for at least 3 seconds until the appliance displays:

ENGLISH SELECTED

The appliance then displays the setting message in English. If you select the wrong language by mistake, follow the instructions in section 17 to choose the right one.

2. After 5 seconds, the appliance displays:

FILL TANK

To fill, remove the tank (fig. 2), rinse and fill with fresh water. Never exceed the MAX line.

Put the tank back and **push as far as it will go**.

3. Place a cup under the hot water spout (fig. 3). If the water spout is not in place, INSERT WATER SPOUT is displayed. Attach it as shown in figure 4, making sure the arrow on the spout is lined up with the arrow on the control panel of the appliance, (fig. 4). The appliance now displays:

PRESS OK

4. Press the OK button (fig. 1) and after a few seconds, a little water will run from the spout (running water stops automatically)

5. The appliance displays:

TURNING OFF PLEASE WAIT

and it goes off.

6. Fill the container with coffee beans (fig. 5).

IMPORTANT: to prevent malfunction, never fill with ground coffee, freeze dried coffee, caramelized beans or anything else which could damage the appliance.

5 TURNING ON AND PREHEATING

1. Press the  button (fig. 6). The appliance displays:

HEATING UP PLEASE WAIT...

to indicate preheating is underway.

2. Once preheating is completed, the appliance displays

RINSING PLEASE WAIT...

and performs an automatic rinse cycle (a little hot water runs from the spouts and is collected in the drip tray below).

Tip: if you want a short coffee (less than 2 oz), to make it hotter, fill the cup with this hot rinsing water first. Leave it for a few seconds then empty it to preheat the cup.



3. The appliance now displays the ready message:

READY STRONG TASTE

6 PREPARING COFFEE (USING COFFEE BEANS)

1. The appliance is preset to make coffee with a strong taste. You can also choose coffee with a mild or regular taste. To choose the required taste, press the  button (fig. 7). The selected coffee taste will be displayed.

2. Place 1 cup under the spouts to make 1 shot (fig. 8) or 2 cups for 2 shots (fig. 9). For a creamier coffee, lower the spouts to bring them as close to the cups as possible (fig. 10).

3. Press the  button to make one shot espresso (fig. 11), the  button for two shots espresso and the  button for a long shot.

To change the quantity of coffee delivered automatically into the cup, follow the instructions in section 7.

(The appliance now grinds the beans and starts brewing the coffee into the cup.

Once the desired quantity has been reached, the appliance automatically stops delivering the coffee and ejects the grounds into the coffee grounds container).

4. After a few seconds, the ready message is displayed again and you can make another coffee.

5. To turn the appliance off, press the  button.

Before going off, the appliance performs an automatic rinse cycle (a little hot water runs out from the spouts and is collected in the drip tray beneath). *Take care to avoid scalds.*

NOTE 1: *If the coffee is delivered a drop at a time or not at all, turn the grinding coarseness regulator (fig. 12) one click clockwise (see section 8).*



Turn one click at a time until the coffee is delivered adequately.



NOTE 2: *If the coffee is delivered too fast and is not creamy enough, turn the grinding coarseness regulator (fig. 12) one click counterclockwise (see section 8).*

Avoid turning the grinding coarseness regulator excessively otherwise when you select 2 cups, the coffee may run out in drips. Mill should only be adjusted while running to prevent jamming.

NOTE 3: *Tips to make hotter coffee:*

- **When you turn the appliance on**, if you want to make a short coffee (less than 2 oz), use the hot rinse-through water to preheat the cups.
If **2-3 minutes have passed**, since you last made coffee, before making coffee again you must preheat the infuser by pressing the button  (fig. 13).
Run off the water into the underlying drip tray or alternatively use this water to fill (and then empty) the cup to be used for the coffee, so as to preheat it.
- Unless preheated, do not use cups that are too thick, as they will absorb too much heat.
- Use cups that have been preheated by rinsing them with hot water or by leaving them for at least 20 minutes on the cup warmer tray on top of the appliance with the appliance on.

NOTE 4: While the appliance is making the coffee, **delivery can be stopped at any time** by pressing the ,  or  button as previously selected.

NOTE 5: As soon as delivery is complete, to **increase the quantity** of coffee, simply press and hold the ,  or  button as previously selected, until the desired quantity is reached (this operation must be performed within 3 seconds from when coffee delivery from the spouts ceases).

NOTE 6: *When the appliance displays:*

FILL TANK

the water tank must be refilled or the appliance will not make coffee.
(It is normal for there to be a little water left in the tank when the message is displayed).

NOTE 7: The appliance counts the number of coffees made. Every 14 single coffees (or 7 doubles) the appliance displays:

EMPTY GROUNDS CONTAINER

indicating that the grounds container is full and must be emptied and cleaned. Until the grounds container has been cleaned, the appliance continues to display the message and cannot make coffee.

To clean, open the service door at the front by pulling the coffee spout (fig. 14), remove the drip tray (fig. 15), empty and clean.

Empty the grounds container and clean thoroughly, making sure all residue deposited on the bottom is removed.

IMPORTANT: *When removing the drip tray, the grounds container **MUST** be emptied, even if it is not completely full. If this is not done, when making your next coffee, the grounds in the container may exceed the maximum level and block the appliance.*

NOTE 8: while the appliance is delivering coffee, never remove the water tank. If it is removed, it will not be possible to make the coffee and the appliance will display:

*GROUND TOO FINE ADJUST MILL AND
INSERT WATER SPOUT AND PRESS OK*

To turn the appliance on again, you must insert the water spout (fig. 4), press the **OK** button and run off water from the spout for a few seconds.

When using the appliance for the first time, 4-5 cups of coffee need to be made before the appliance starts to give satisfying results.

If the appliance malfunctions, do not contact the service center right away.

The problem can almost always be resolved by following the instructions indicated in sections 18 and 19.

If this is not the case, or for further explanations, contact customer service by calling the number listed in the warranty or visit www.delonghi.com for a list of service centers near you. (U.S. and Canada)

7 CHANGING THE QUANTITY OF COFFEE IN THE CUP

The appliance is factory preset to automatically deliver the following quantities of coffee:

- 1 shot espresso (when the ☕ button is pressed);
- 2 shots espresso (when the ☕☕ button is pressed);
- long shot (when the ☕☕☕ button is pressed);

To change these quantities, proceed as follows:

- press the button corresponding to the quantity you want to change (☕ , ☕☕ or ☕☕☕) for at least 8 seconds until the message "PROGRAM QUANTITY" is displayed and coffee is delivered;
- when the coffee in the cup reaches the required level, press the same button again to memorize the new amount.

The appliance is now re-programmed with the new settings and displays: READY.

8 REGULATING THE COFFEE MILL

After making the first coffees, if you find that coffee delivery is either too fast or too slow (in drips), the grinding coarseness regulator can be adjusted

Turning it 1 click (1 number) clockwise speeds up coffee delivery (without drips).

Turning it 1 click counterclockwise slows down delivery giving a creamier appearance to the coffee.

These adjustments will only be evident after at least 2 cups of coffee have been brewed.

The grinding coarseness regulator must only be turned when the coffee mill is running.

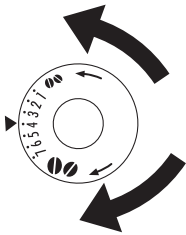

Turn counterclockwise to obtain finer ground coffee, slower delivery and a creamier appearance.



Turn clockwise for coarser ground coffee and faster delivery (not a drop at a time).

Coffee has been used to factory test the appliance and it is therefore completely normal for there to be traces of coffee in the mill. This appliance is however guaranteed to be new.

9 PREPARING ESPRESSO/COFFEE USING GROUND COFFEE (INSTEAD OF BEANS)

- Press the  button (fig. 16) to select the ground coffee function. This disables the coffee mill function. The appliance displays

READY PRE-GROUND

- Lift the central lid, place one level measure of ground coffee in the funnel (see fig. 17) and proceed as described in section 6. Note: You can make just one coffee at a time by pressing the ,  or  button once only.

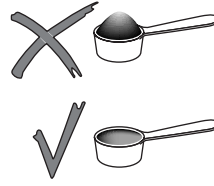

NOTE 1: Never add the ground coffee when the appliance is off to avoid it being dispersed inside the appliance.

NOTE 2: Never add more than one level measured scoop, otherwise either the appliance will not make the coffee, the ground coffee will be lost inside the appliance, dirtying it, or the coffee will run off in drips and the message "GROUND TOO FINE ADJUST MILL AND INSERT WATER SPOUT AND PRESS OK" will be displayed.

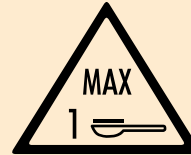

NOTE 3: When measuring the quantity of coffee to be added, use the measuring scoop supplied only.

NOTE 4: Use ground coffee for espresso coffee makers only. Do not use coffee beans, freeze-dried coffee or other materials that could damage the appliance.

NOTE 5: If the funnel blocks due to moisture inside the appliance or if more than one measure of pre-ground coffee has been used, use a knife to push the coffee down (Fig. 18), then remove and clean the infuser and appliance as described in section 15.2 "Cleaning the infuser".

- Once the coffee has been delivered, to go back to making coffee using beans, deactivate the ground coffee function by pressing the  button again (the light goes off and the coffee mill is enabled for operation again).

10 PRODUCING HOT WATER

- Always make sure the appliance is ready.
- Make sure the water spout is attached to the nozzle (fig. 4);
- Position a container under the spout (fig. 3).
- Press the  button (fig. 1).

The appliance displays:

HOT WATER

and hot water is delivered from the water spout into the container below (you should not run off hot water for more than two minutes at a time). To stop the flow, press the  button. Once the set quantity of hot water has been reached, delivery stops automatically.

11 CHANGING THE QUANTITY OF HOT WATER

The appliance is factory preset to automatically deliver 8.5 oz of hot water.

To change this quantity, proceed as follows:

- Attach the water spout (fig. 4).
- Position a container under the spout (fig. 3).
- Press the  button for at least 8 seconds then release. The appliance displays:

HOT WATER PROGRAM QUANTITY

and hot water is delivered from the water spout.

- When the hot water in the cup reaches the required level, press the  button to memorize the new amount. (You should not run off hot water for more than two minutes at a time).

12 PREPARING LATTE OR CAPPUCCINOS (MILK WITH COFFEE)

- Select the taste of the coffee you want to use to make the cappuccino by pressing the  button.
- Remove the frothed milk lid from the milk container.
- Fill the container with about 3.5 ounces of milk for each cappuccino to be prepared (fig. 19). **Never exceed the MAX level (corresponding to about 25 oz) marked on the container.** You are recommended to use milk at refrigerator temperature (about 41 °F/5° C).
- Make sure the milk intake tube is correctly inserted in the rubber washer (fig. 20), then put the lid on the milk container.
- Remove the hot water spout (fig. 21) and attach the milk container to the nozzle making sure the arrow on the container lid is lined up with the arrow on the control panel of the appliance (fig. 22).
- Position the milk spout as shown in fig. 23 and then place a sufficiently large cup under the coffee and milk spout.
- If you want to make caffelatte (hot milk + coffee), put the froth regulator on CAFFELATTE.
- If you want to make cappuccino (frothed milk + coffee) using whole milk, put the froth regulator on CAPPUCCINO.
- If you want to make cappuccino (frothed milk + coffee) using non-fat milk, put the froth regulator on CAPPUCCINO NON FAT.

NOTE: you can put the milk froth regulator in-between the two positions to personalize the volume of the froth.

- Press the  button (fig. 24). The appliance displays:

CAPPUCCINO OR LATTE

and after a few seconds, the milk is delivered from the milk spout into the cup below. (Delivery stops automatically).

- The appliance then grinds the beans, delivers the coffee and displays the "ready" message again.
- The cappuccino is ready. Sweeten to taste and, if desired, sprinkle the froth with a little cocoa powder.

NOTE 1: While preparing the cappuccino, milk or coffee delivery can be interrupted by pressing button .

NOTE 2: If you run out of milk while delivering the milk, remove the container and refill it. Then put it back in place and press the  button to request a cappuccino again.

NOTE 3: To ensure the milk frother is absolutely clean and hygienic, after making cappuccinos, clean the channels inside the milk container lid:

- Place a cup under the milk spout;
- Press the **CLEAN** button on the frothed milk container lid and hold down for at least 8 seconds. The appliance displays:

CLEANING

After cleaning is complete, remove the milk container and place in the refrigerator. You should not leave the milk outside the refrigerator for more than 15 minutes.

NOTE 4: To change the quantity of coffee or milk delivered automatically into the cup, follow the instructions in section 14.

13 PREPARING STEAMED OR FROTHED MILK (WITHOUT COFFEE)

- Remove the lid of the milk container.
- Fill the container with the quantity of milk you want to prepare (fig. 19).
- Put the lid on the milk container. Ensure the milk intake tube is attached.
- Attach the milk container to the appliance (fig. 22)
- Place a sufficiently large cup under the milk spout (fig. 23).
- If you want to prepare frothed milk using whole milk, put the froth regulator on CAPPUCCINO (fig. 25C) stamped on the milk container lid. If you want to prepare frothed milk using non-fat-milk, put the froth regulator on CAPPUCCINO NON FAT (fig. 25B).
- If, on the other hand, you want to prepare hot milk, put the froth regulator on CAFFELATTE (fig. 25A).
- Press button  twice (within 2 seconds). The appliance displays:

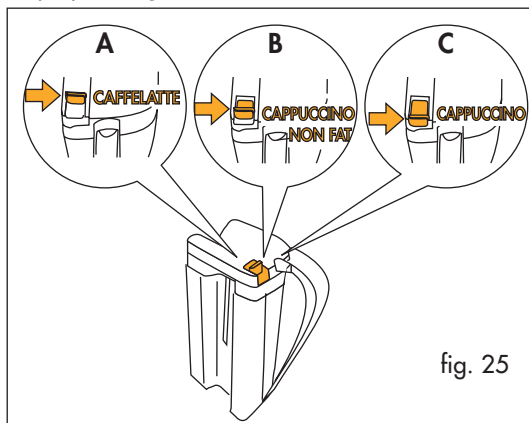

FROTHING OR STEAMING

and after a few seconds, the milk is delivered from the milk spout into the cup below. (Delivery stops automatically).

- After delivery is complete, clean the channels inside the milk container lid by pressing the CLEAN button as described in the previous section (note 3).

14 CHANGING THE QUANTITY OF COFFEE AND MILK FOR LATTES OR CAPPUCCINOS

The appliance is factory preset to automatically deliver a standard cappuccino. To change these quantities, proceed as follows:

- Fill the container with milk up to the maximum level indicated on the container.
- Press the  button for at least 8 seconds then release the button.
- The appliance displays:

MILK FOR CAPPUCCINO PROGRAM QUANTITY

and starts to run off milk.

- Once the required quantity of milk has been run off, press the  button again. Milk delivery stops and the quantity is memorized. You should not run frothed milk for more than 3 minutes at a time.
- After a few seconds, the appliance delivers coffee into the cup and displays:

COFFEE FOR CAPPUCCINO PROGRAM QUANTITY

- Once the required quantity of coffee has been delivered, press the  button again. Coffee delivery stops and the quantity is memorized.

The appliance is now re-programmed with the new settings and displays: *READY*.

15 CLEANING AND MAINTENANCE

Before performing any cleaning operations, leave the appliance to cool down and unplug from the outlet. Never immerse the coffee maker in water. It is an electrical appliance.

Do not use solvents or abrasive cleaning products to clean the appliance. A soft damp cloth will suffice. The infuser, grounds container, water tank and drip tray must NEVER be washed in the dishwasher.

15.1 Cleaning the coffee maker

Clean the grounds container (as described in section 6, note 7) whenever it requires emptying.

The water tank should also be cleaned regularly.

The drip tray is fitted with a level indicator (red) showing the level of water it contains. When the indicator starts to become visible (a few millimeters under the drip tray), the drip tray must be emptied and cleaned. Check that the holes in the coffee spout are not blocked. To unblock them, scrape the dry coffee residues away with a needle (fig. 27).

Clean the nozzle regularly with a sponge as shown in fig. 26.

15.2 Cleaning the infuser

The infuser must be cleaned regularly to avoid the build-up of coffee encrustations which could cause malfunction.

Proceed as follows:

- Turn the appliance off by pressing the ① button (fig. 6) (do not unplug) and wait for the display to go off;
- Open the service door (fig. 14);
- Remove the drip tray and the grounds container (fig. 15) and clean;
- Press the two red release buttons on the infuser (fig. 28) and pull it out;
- **IMPORTANT: THE INFUSER CAN ONLY BE REMOVED WHEN THE APPLIANCE IS OFF. ATTEMPTING TO REMOVE THE INFUSER WITH THE APPLIANCE ON MAY CAUSE SERIOUS DAMAGE.**
- Wash the infuser under running water, without using detergents. Never wash the infuser in the dishwasher;
- Clean the inside of the appliance thoroughly. To remove coffee encrustations from the inside of the appliance, scrape with a plastic or wooden fork (fig. 29) then vacuum up the residues with a vacuum cleaner (fig. 30);
- Replace the infuser by sliding it onto the supports and pin at the bottom, then push the PUSH symbol fully in until it clicks into place.

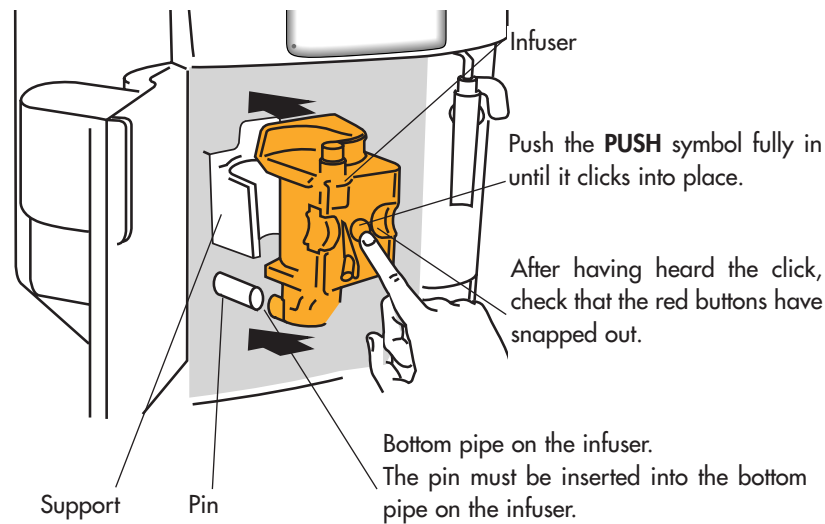

Check that the two red buttons have snapped out, otherwise the door cannot be closed.

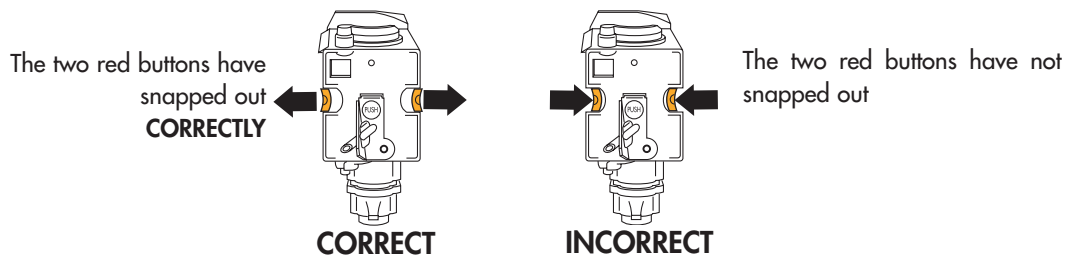

NOTE 1: If the infuser is not inserted correctly, until it clicks into place, and the two red buttons have not snapped out, the service door cannot be closed.

NOTE 2: If it is hard to insert the infuser, before inserting it, squeeze it to the right size by pressing it forcefully from the top and bottom simultaneously, as shown in figure 31.

NOTE 3: If it is still hard to insert the infuser, leave it out of the appliance, close the service door, unplug from the outlet then plug in again. Wait for all the lights to go off, then open the door and replace the infuser.

- replace the drip tray, complete with the grounds container;
- close the service door.

15.3 Cleaning the milk container

Proceed as follows:

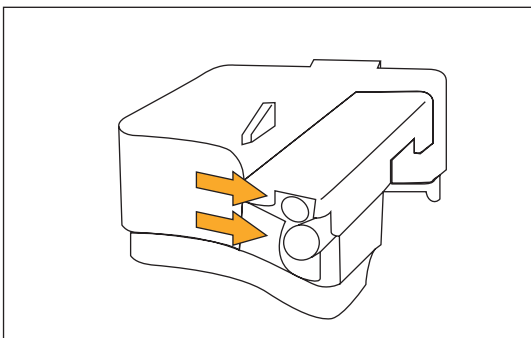

- Remove the milk spout (fig. 32) and the milk intake tube.
- Remove the milk froth regulator by pulling it outwards.
- Wash the container and lid in hot soapy water. Make sure there is no milk residue inside the two holes in the lid of the milk container indicated by the arrows in the figure or the milk intake tube.
- Replace the milk froth regulator, the milk intake tube and the milk spouts.

16 CHANGING AND SETTING THE MENU PARAMETERS

After pressing the ① button, when the appliance is ready, you can use the internal menu to modify the following parameters and functions:

- Clock
- Auto-start time
- Descaling process
- Coffee temperature
- Length of time the appliance remains on
- Water hardness
- Factory default values
- Language

16.1 Setting the clock

To set the clock, proceed as follows:

- Press the **MENU** button (the light over the button comes on) then press the **NEXT** button repeatedly until the appliance displays

CLOCK 00:00

- Press the button **CHANGE** to set the clock. (If you hold the **CHANGE**, button down, the time is changed rapidly).
- Press the **OK** button to confirm the value;
- Press the **MENU** button to exit programming mode or **NEXT** to change other parameters.

16.2 Setting auto-start time

This programs the time the appliance will come on automatically.

- Make sure the clock on the appliance is set as described above
- Press the **MENU** button (the light over the button comes on) then press the **NEXT** button repeatedly until the appliance displays:

START TIME 00:00

- Press the **CHANGE** button to set the auto-start time. (If you hold the **CHANGE**, button down, the time is changed rapidly).
- Press the **OK** button to confirm the value,
- Press **NEXT** once and the appliance displays the message:

AUTO-START NO

Press the **CHANGE** button to modify the function (the appliance displays AUTO-START YES");

- Press the **OK** button to activate auto-start;

NOTE: when the appliance is turned off and auto-start time is set, the symbol  appears alongside the time on the unlit display.

- Press the **MENU** button to exit programming mode or **NEXT** to change other parameters.

16.3 Descale

Over time, the continuous heating up of the water used to make the coffee leads to lime scale building up in the inner circuits of the appliance.

When the appliance displays the message:

DESCALE

you should perform the descale cycle. Proceed as follows:

- make sure the appliance is ready.
- press the **MENU** button (the light over the button comes on) then press the **NEXT** button repeatedly until the appliance displays:

DESCALE NO

- Press **CHANGE** and the appliance displays the message:

DESCALE YES

- Press the **OK** button to start the descale program.
- Empty the water tank and pour in the contents of one bottle (4.2 fl. oz.) of DURGOL descaler plus 34 oz. of water. For subsequent descaling operations, descaling solution can be purchased from authorized technical service centers.

Note: Make sure splashes of descaler do not fall onto surfaces sensitive to acid such as marble, limestone and granite.

- attach the water spout to the nozzle;
- place a plastic or glass container with a minimum capacity of 34 oz under the hot water spout (Fig. 3);
- press the **OK** button. Descaler runs off from the hot water spout into the container below. The appliance displays:

APPLIANCE IN DESCAL

- the descale program automatically performs a series of run offs and pauses to remove lime scale deposits from inside the coffee maker.
- After about 30 minutes, the appliance displays:

RINSING FILL TANK

The appliance must now be rinsed thoroughly to eliminate residues of descaling solution from inside the appliance. Proceed as follows:

- empty the water tank, rinse and fill with clean water.
- reposition the tank.
- empty the full container and then put it back under the hot water spout.
- Press the **OK** button. Hot water will run off from the spout continuously into the container below and the appliance displays:

RINSING

- When the water tank is empty, the appliance displays the message:

RINSING COMPLETE PRESS OK

- Press the **OK** button and refill the water tank with clean water.
- The descale program is now terminated and the appliance is ready to make coffee again.

NOTE: If the descaling cycle is interrupted before completion, the appliance continues to display the descale message and the program must be started again from the beginning. Empty the water tank, rinse, fill with clean water and run off a cup of hot water.

IMPORTANT: FAILURE TO DESCAL THE APPLIANCE REGULARLY INVALIDATES THE WARRANTY.

16.4 Changing coffee temperature

To change the temperature of the coffee, proceed as follows:

- Press the **MENU** button (the light over the button comes on) then press the **NEXT** button repeatedly until the appliance displays:

HOT

- Press the **CHANGE** button until the appliance displays the required coffee temperature (HOT, EXTRA HOT, WARM).
- Press the **OK** button to confirm the temperature selected;
- Press the **MENU** button to exit programming mode or **NEXT** to change other parameters.

16.5 Changing the length of time the appliance remains on

The appliance is factory preset to go off automatically one hour after the last coffee has been made. The number of hours (max. 3) the appliance remains on can be increased as follows:

- Press the **MENU** button (the light over the button comes on) then press the **NEXT** button repeatedly until the appliance displays:

OFF AFTER 1 HOUR

- Press the **CHANGE** button to change the number of hours the appliance remains on
- Press the **OK** button to confirm the value;
- Press the **MENU** button to exit programming mode or **NEXT** to change other parameters.

16.6 Setting water hardness

The descale message is displayed after the appliance has been operated for a factory set period of time calculated on the basis of the maximum quantity of lime scale which may be contained in the water used. If necessary, this period of operation can be extended, making descaling less frequent, by programming the appliance based on the actual lime content in the water used. Proceed as follows:

- Remove the "Total Hardness Test" strip (enclosed on page 2) from its packaging then dip it fully in the water tank for a few seconds, Remove it and wait about 30 seconds (until it changes color and a number of red squares are formed);
- Turn the appliance on by pressing the  button (fig. 6).
- Press the **MENU** button (the light over the button comes on) then press the **NEXT** button repeatedly until the appliance displays:

WATER HARDNESS 4

- Press the **CHANGE** button repeatedly until the number coincides with the number of red squares on the test strip (for example, if there are 3 red squares on the test strip, press the button until WATER HARDNESS 3 is displayed).
- Press the **OK** button to confirm the value. The coffee maker is now programmed to provide the descaling warning when necessary, based on the actual hardness of the water.

16.7 Resetting factory default settings

If you change the original values, the factory default values can be reset as follows:

- Press the **MENU** button (the light over the button comes on) then press the **NEXT** button repeatedly until the appliance displays:





RESET TO DEFAULT NO

- Press the **CHANGE** button and the appliance displays "RESET TO DEFAULT YES";
- Press the **OK** button to reset the factory default values;
- The appliance is now reset to the factory default settings and the READY message is displayed.

17 CHANGING THE LANGUAGE

To change the language, press the **CHANGE** button for at least 5 seconds until the appliance displays the installation message in various languages. To select the required language, follow the instructions in section 4.1.







18 TROUBLESHOOTING

MESSAGE	MEANING	WHAT TO DO
<i>FILL TANK</i>	<ul style="list-style-type: none"> The water tank is empty or is positioned incorrectly. The tank is dirty or encrusted with lime scale. 	<ul style="list-style-type: none"> Fill the water tank as described in section 6, note 6 and insert it fully. Rinse or descale the tank.
<i>GROUND TOO FINE ADJUST MILL AND INSERT WATER SPOUT AND PRESS OK</i>	<ul style="list-style-type: none"> The appliance cannot make coffee The coffee runs off too slowly. 	<ul style="list-style-type: none"> Insert the hot water spout, press the  button and run off water from the spout for a few seconds. Turn the grinding regulator (fig. 12) one click clockwise (see section 8).
<i>EMPTY GROUNDS CONTAINER</i>	<ul style="list-style-type: none"> The grounds container is full or missing. 	<ul style="list-style-type: none"> Empty the grounds container and clean as described in section 6, note 7, then replace.
<i>INSERT GROUNDS CONTAINER</i>	<ul style="list-style-type: none"> After cleaning, the grounds container has not been replaced. 	<ul style="list-style-type: none"> Open the service door and insert the grounds container.
<i>ADD PRE-GROUND COFFEE</i>	<ul style="list-style-type: none"> With the function selected, the pre-ground coffee has not been poured into the funnel. 	<ul style="list-style-type: none"> Add the ground coffee as described in section 9.
<i>FILL BEANS CONTAINER</i>	<ul style="list-style-type: none"> The coffee beans have run out. If the coffee grinder is very noisy, this means a small stone in the coffee beans has blocked the mill. 	<ul style="list-style-type: none"> Fill bean container. Contact an authorized De' Longhi service center.
<i>DESCALE</i>	<ul style="list-style-type: none"> This indicates the presence of lime scale in the appliance. 	<ul style="list-style-type: none"> The descaling procedure, described in section 16.3, needs to be performed as soon as possible.
<i>CLOSE DOOR</i>	<ul style="list-style-type: none"> The service door is open 	<ul style="list-style-type: none"> If the service door cannot be closed, check that the infuser is inserted correctly (section 15.2 - note 1).
<i>INSERT WATER SPOUT</i>	<ul style="list-style-type: none">  button has been pressed and the water spout is not inserted 	<ul style="list-style-type: none"> Insert water spout (fig. 4)
<i>INSERT INFUSER ASSEMBLY</i>	<ul style="list-style-type: none"> After cleaning, the infuser has probably been left out of the coffee maker. 	<ul style="list-style-type: none"> Insert the infuser, see section 15.2
<i>LESS COFFEE</i>	<ul style="list-style-type: none"> The ground coffee funnel is clogged. Too many coffee beans or too much ground coffee has been added. 	<ul style="list-style-type: none"> Empty the funnel with the help of a knife, as described in section 9, note 5 (Fig.18). Select a milder taste or reduce the quantity of ground coffee, then press ,  to deliver the coffee again.
<i>GENERIC ALARM</i>	<ul style="list-style-type: none"> The inside of the appliance is very dirty. 	<ul style="list-style-type: none"> Clean the inside of the appliance thoroughly, as described in section 15.2. If the message is still displayed after cleaning, contact a service center.

19 PROBLEMS TO BE RESOLVED BEFORE CALLING THE SERVICE CENTER

If the appliance is not working and an alarm light is on, the causes of the malfunction can be identified and resolved by referring to section 18.

If, on the other hand, no alarm light is on, run the following checks before calling the service center.

PROBLEM	CAUSE	SOLUTION
The coffee is not hot	<ul style="list-style-type: none"> The cups have not been preheated. The infuser is too cold 	<ul style="list-style-type: none"> Heat the cups by rinsing them in hot water or leaving them for at least 20 minutes on the cup warmer tray on the lid (see tip, section 5 and note 3, section 6). Heat the infuser by pressing the  button before making the coffee (fig. 13, see note 3, section 6).
The coffee is not creamy enough	<ul style="list-style-type: none"> The coffee is ground too coarsely Wrong type of coffee is being used. 	<ul style="list-style-type: none"> Turn the grinding regulator one click counterclockwise (see section 8). Use a type of coffee for espresso coffee makers.
The coffee runs out too slowly.	<ul style="list-style-type: none"> The coffee is ground too finely. 	<ul style="list-style-type: none"> Turn the grinding regulator one click clockwise (see section 8).
The coffee runs out too quickly.	<ul style="list-style-type: none"> The coffee is ground too coarsely. 	<ul style="list-style-type: none"> Turn the grinding regulator one click counterclockwise (see section 8).
The coffee does not come out of one of the spouts.	<ul style="list-style-type: none"> The spout holes are blocked. 	<ul style="list-style-type: none"> Scrape off the dry coffee residues with a needle (fig. 27).
When coffee beans are being used and the  ,  or  , button is pressed, the appliance does not deliver coffee, but only water.	<ul style="list-style-type: none"> The ground coffee may be blocked in the funnel. 	<ul style="list-style-type: none"> Remove the ground coffee inside the funnel using a knife (see section 9 - note 5). Then clean the infuser and the inside of the appliance (see description in section 15.2).
When the  button is pressed, the appliance does not turn on.	<ul style="list-style-type: none"> The appliance is not plugged in. 	<ul style="list-style-type: none"> Check that the power cable is plugged into the outlet.
The infuser cannot be removed for cleaning.	<ul style="list-style-type: none"> The appliance is on. The infuser can only be removed if the appliance is off. 	<ul style="list-style-type: none"> Turn the appliance off and remove the infuser (see section 15.2). IMPORTANT: the infuser can only be removed if the appliance is off. Attempting to remove the infuser when the appliance is on may cause serious damage.
Ground coffee is being used (not beans) and the appliance does not deliver the coffee.	<ul style="list-style-type: none"> Too much ground coffee has been added. The  button has not been pressed and the appliance has used both the ground coffee added and the coffee ground by the mill Ground coffee has been added when the appliance is off. 	<ul style="list-style-type: none"> Remove the infuser and thoroughly clean the inside of the appliance, as described in section 15.2. Repeat the operation using a maximum of 1 measuring scoop of ground coffee. Thoroughly clean the inside of the appliance, as described in section 15.2. Repeat the operation, first pressing the  button as described in section 9. Remove the infuser and thoroughly clean the inside of the appliance, as described in section 15.2. Repeat the operation, but switch the appliance on first.

PROBLEM	CAUSE	SOLUTION
The coffee does not run out from the spouts, but from around the service door.	<ul style="list-style-type: none"> The holes in the spouts are clogged with dry coffee. The mobile drawer inside the service door is blocked and cannot swing. 	<ul style="list-style-type: none"> Scrape the holes with a needle (see section 15.1, Fig. 27). Thoroughly clean the mobile drawer, particularly near the hinges to ensure they are free to swing smoothly.
The milk does not run out of the milk spout.	<ul style="list-style-type: none"> The intake tube is not inserted or is inserted incorrectly. 	<ul style="list-style-type: none"> Insert the intake tube in the rubber washer in the milk container lid (fig. 20).
The milk is not well frothed.	<ul style="list-style-type: none"> The milk container lid is dirty. 	<ul style="list-style-type: none"> Clean the milk lid as described in section 15.3.
The milk contains bubbles or squirts out of the milk spout.	<ul style="list-style-type: none"> The milk is not cold enough. 	<ul style="list-style-type: none"> Use milk at refrigerator temperature. If you are still not getting the required results, try changing the brand of milk.



This warranty applies to Super Automatic Espresso Machines with the De'Longhi brand name.

LIMITED WARRANTY

What does the warranty cover?

We warrant each appliance to be free from defects in material and workmanship. Our obligation under this warranty is limited to repair at our factory or authorized service center of any defective parts or part thereof, other than parts damaged in transit. The repaired or new model will be returned at the company expense.

This warranty shall apply only if the appliance is used in accordance with the factory directions, which accompany it, and on an alternating current (AC) circuit.

How long does the coverage last?

This warranty runs for two years (2) from the purchase date found on your receipt and applies only to the original purchaser for use.

What is not covered by the warranty?

The warranty does not cover defects or damage of the appliance, which result from repairs or alterations to the appliance outside our factory or authorized service centers, nor shall it apply to any appliance, which has been subject to abuse, misuse, negligence or accidents. Also, consequential and incidental damage resulting from the use of this product or arising out of any breach of contract or breach of this warranty are not recoverable under this warranty. Some states do not allow the exclusion or limitation of incidental or consequential damage, so the above limitation may not apply to you.

How do you get service?

If repairs become necessary, see contact information below:

U.S. Residents:

Please contact our toll free hotline at #1-866-Latte-Best or log onto our website at www.delonghi.com. For all accessories, spare parts or replacement parts, please contact our parts division at 1-866-528-8323.

Residents of Canada:

Please contact our toll free hotline at #1-866-Latte-Best or 1-866-528-8323 (Hours of Operation: Monday - Friday 8:30am - 8pm, Saturday & Sunday 9:00am - 5:30pm) or log onto our website at www.delonghi.com.

Residents of Mexico:

Please refer to the Limited Warranty statement for Mexico (page 63).

Please refer to the back page of the manual for De'Longhi addresses.

The above warranty is in lieu of all other express warranties and representations. All implied warranties are limited to the applicable warranty period set forth above. This limitation does not apply if you enter into an extended warranty with De'Longhi. Some states do not allow limitations on how long an implied warranty lasts, so the above exclusions may not apply to you. De'Longhi does not authorize any other person or company to assume for it any liability in connection with the sale or use of its appliance.

How does state law apply?

This warranty gives you specific legal rights, and you may also have other rights, which vary from state to state.