

This Owner's Manual is provided and hosted by [Appliance Factory Parts](http://www.appliancefactoryparts.com).

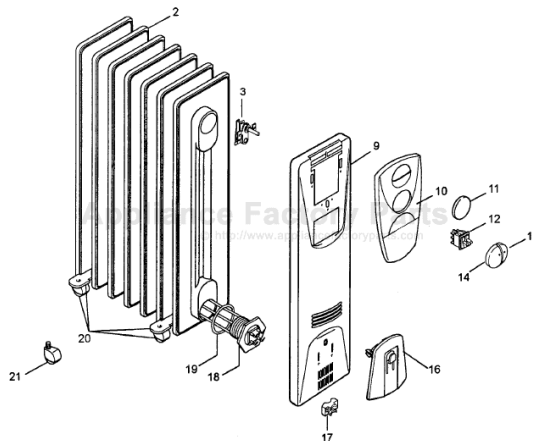

DE'LONGHI RO30715 Owner's Manual

[Shop genuine replacement parts for DE'LONGHI
RO30715](#)



[Find Your DE'LONGHI HVAC Parts - Select From 166 Models](#)

----- Manual continues below -----



**IMPORTANT INSTRUCTIONS
ELECTRIC OIL FILLED RADIATORS
SAVE THESE INSTRUCTIONS**



TYPE/MODELO: MG15T



**The De' Longhi electric oil filled radiators are the finest and most versatile portable heaters available.
Please review the following to ensure the fullest benefit from their features.**



IMPORTANT SAFEGUARDS

When using electrical appliances, basic precautions should always be followed to reduce risk of fire, electric shock, and injury to persons, including the following:

1. Read all instructions before using this heater.
2. **Never for any reason cover the appliance during operation as this could lead to dangerous overheating.**
3. This heater is hot when in use. To avoid burns, do not let bare skin touch hot surfaces. Use handle when moving this heater. Keep combustible materials, such as furniture, pillows, bedding, papers, clothes, and curtains at least 3 feet (0,9 m) from the front and top of the heater and keep them away from the sides and rear.
4. Extreme caution is necessary when any heater is used by or near children or invalids and whenever the heater is left operating and unattended.
5. Always unplug heater when not in use.
6. **Do not operate any heater with a damaged cord or plug or after the heater malfunctions, has been dropped or damaged in any manner. If heater has leaked any oil, discontinue using the heater and contact the service center as indicated in this instructions leaflet. Return heater to authorized service facility for examination, electrical or mechanical adjustment, or repair.**
7. Do not use outdoors.
8. This heater is not intended for use in bathrooms, laundry areas and similar indoor locations. Never locate heater where it may fall into a bathtub or other water container.
9. **Do not run cord under carpeting. Do not cover cord with throw rugs, runners, or the like. Arrange cord away from traffic area and where it will not be tripped over.**
10. To disconnect heater, turn controls to off, then remove plug from outlet.
11. Connect to properly polarized outlets only.
12. Do not insert or allow foreign objects to enter any ventilation or exhaust opening as this may cause an electric shock, fire, or damage the heater.
13. To prevent a possible fire, do not block air intakes or exhaust in any manner. Do not use on soft surfaces, like a bed, where openings may become blocked.
14. **A heater has hot or arcing or sparking parts inside. Do not use it in areas where gasoline, paint, or flammable liquids are used or stored.**
15. Use this heater only as described in this manual. Any other use not recommended by the manufacturer may cause fire, electric shock, or injury to persons.
16. To prevent overload and blown fuses, be sure that no other appliance is plugged into the same outlet (receptacle) or into another outlet (receptacle) wired into the same circuit.
17. It is normal for the heater's plug and cord to feel warm to the touch. A plug or cord which becomes hot to the touch or becomes distorted in shape may be a result of a worn electrical outlet. Worn outlets or receptacles should be replaced prior to further use of the heater. Plugging heater into a worn outlet /receptacle/ may result in overheating of the power cord or fire.
18. **Do not use an extension cord because it may overheat and cause a risk of fire. However, if you have to use an extension cord, the cord shall be properly grounded No. 14 AWG minimum size and rated not less than 1875 watts, and has to be used only for supplying power to this heater.**
19. Be sure that the plug is fully inserted into an appropriate receptacle in order to prevent any danger of overheating or arcing. Please remember that receptacles also deteriorate due to aging and continuous use: check periodically if signs overheating or deformations are evidenced by the plug. Do not use the receptacle and **CALL** your electrician.
20. Check that neither the appliance nor the power cable have been damaged in any way during transportation.
21. Make sure that no pieces of polystyrene or other packaging material have been left between one element of the appliance and another. It may be necessary to pass over the appliance with a vacuum cleaner.
22. **When switching on the appliance for the first time, allow it to run at full power for about two**

HOW TO USE YOUR HEATER

FITTING THE WHEELS

Remove the feet and the wheels from the polystyrene packing. Turn the radiator upside-down and rest on the polystyrene.

Fit the wheels to the spindles on the feet and push firmly until they click into position. Pull each wheel to check that it is correctly inserted.

The feet with the casters must be fitted with two arc-shaped brackets only between the 1st and 2nd element (see fig. 1 to 4 inclusive).

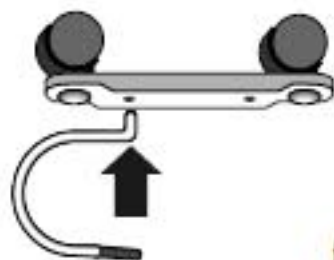

fig. 1

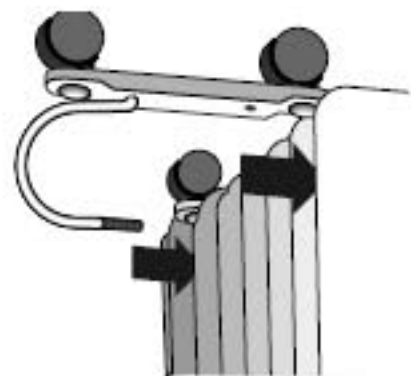

fig. 2

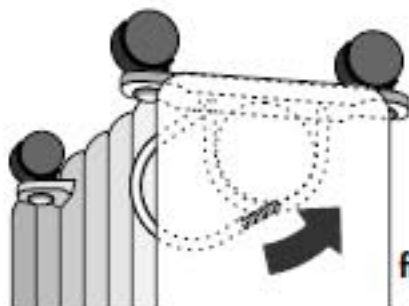

fig. 3

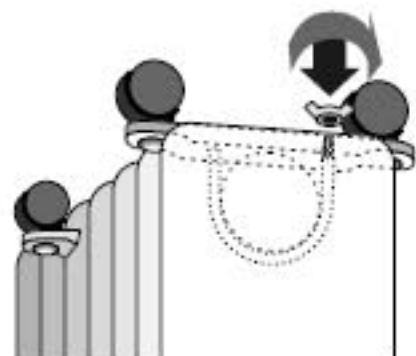
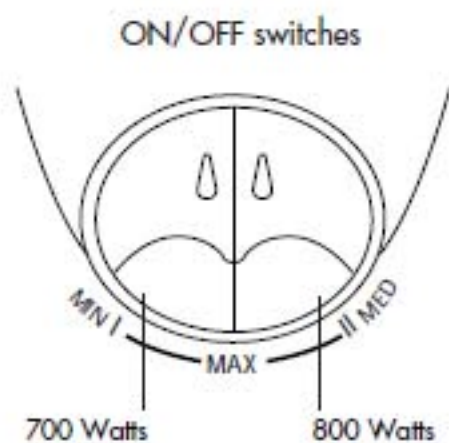

fig. 4

BE CAREFUL

Operate the heater in upright position only (wheels on the bottom, controls on the top). Any other position could create hazard situation!



ECONOMIZER

For more economical use, the Min. or Med. Watt switches may be used individually, after unit has reached the operating temperature.

1. LOCATION

Place heater on floor beneath coldest window in the room or any desired location. Your heater will minimize the effect of cold drafts.

The heater must not be located immediately below a socket-outlet.

Do not use this radiator in rooms having a surface area less than 4 m².

2. CONNECTION

The radiator must be connected to a properly polarized A/C 110/120 V household outlet in perfect working conditions.

Keep loose clothing or bedding, furniture and flammable material away from the wall outlet where the heater plug is fitted in.

3. SWITCHING ON TWO-SWITCHES MODELS

Turn thermostat clockwise to the maximum position. Switch on both switches. The lights on the switches remain on independent of the cycling of the thermostat. When room reaches desired temperature, turn the thermostat knob counter clockwise very slowly and carefully until you hear a "click". This will automatically set your unit to cycle on and off at that desired heat setting. (For timer instructions, see point 5)

Note: It will normally require approx. 15 minutes to reach operating temperature.

4. USE OF THERMOSTAT

The thermostat operates on room air temperature and not radiator temperature. Counter clockwise direction - lower number, lower temperature. Clockwise direction - higher number, higher temperature.

Antifreeze function

Turn the thermostat to the * position and press the switches. The appliance will maintain a minimum room temperature of approximately 5°C thus preventing freezing with a minimum energy consumption.

REMINDER

To completely shut unit off, ON/OFF switches must be placed in OFF position.

5. UNITS WITH TIMER

Clock setting

The programme/timer, as in all clocks, must be set to the correct time. If for example the time is 9.30 a.m. (day zone), rotate the dial clockwise (following the direction of the arrow) until 9.30 is aligned with the triangular pointer.

IMPORTANT:

DO NOT ROTATE CLOCK DIAL COUNTER CLOCKWISE.

The timer is in effect an electric clock and only works while plug is connected to the power supply. Whenever the plug is disconnected, the timer stops and must be re-set.

Your product is equipped with a polarized alternating current line plug (a plug having one blade wider than the other). This plug will fit into the power outlet only one way. This is a safety feature. If you are unable to insert the plug fully into the outlet, try reversing the plug. If the plug should still fail to fit, contact your electrician to replace your obsolete outlet. Do not defeat the safety purpose of the polarized plug.

HOW TO USE THE TIMER

Please refer to the illustration below:

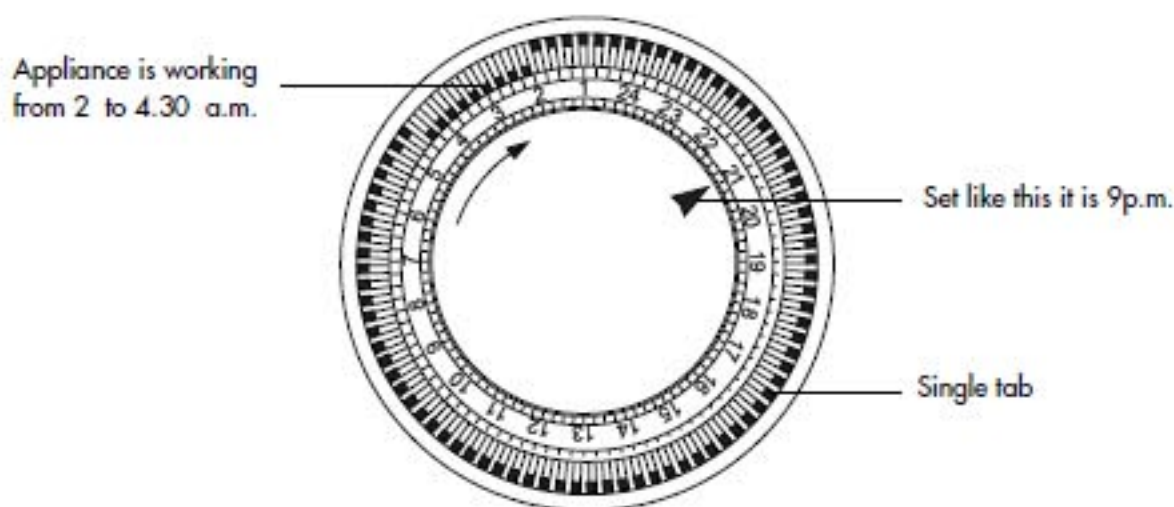

IMPORTANT: There are 96 tabs around the dial. Each tab represents a 1/4 hour (15 minutes) and there is a tab for every quarter hour of the 24 hour day. Your appliance can be programmed to switch itself ON and OFF at the time you want. With the timer you can approximate your setting to within 15 minutes and program up to 48 cycles (1 cycle = 1 "ON" + 1 "OFF") over a period of 24 hours (12 hours a.m.+12 hours p.m.).

The tabs can be pushed inwards or pulled outwards by merely using your fingers. When the tab is in the inward position (towards the center of the dial), the heater **will operate** during that 15 minute period. If the tab is in the outward position, the heater **will not operate** during this period. Please note when you first use your heater, all the tabs are inwards. You must push in those tabs for the period that you want the heater to work. (If you want to bypass the timer check that the all 96 tabs inward).

Timer operation

- Plug in the heater.
- Turn timer dial clockwise to set clock with the current time of day (see CLOCK SETTING).
- Push tabs inwards for the period you want the heater to operate. For example, the illustration shows that appliance will operate from 2 a.m. to 4.30 a.m.
- Push switch(-es) in.
- Once you have set the tabs for the desired heating periods, your heater will cycle on and off according to these settings.
- As long as you keep the heater plugged in, the timer will continue to keep proper time.

6. MAINTENANCE AND SERVICE

Always remove the plug from the power socket and allow the radiator to cool. Wipe radiator with a soft damp cloth, do not use detergents and abrasives.

Should the radiator not be in use over a certain length of time, wind the cable round the holder and store it in a dry place (see fig. in front page).

**De'Longhi**

This warranty applies to all products with De'Longhi or Kenwood brand names.

Limited Warranty

What does the warranty cover?

We warrant each appliance to be free from defects in material and workmanship. Our obligation under this warranty is limited to repair at our factory or authorized service center of any defective parts or part thereof, other than parts damaged in transit. In the event of a products replacement or return, the unit must be returned transportation prepaid. The repaired or new model will be returned at the company expense.

This warranty shall apply only if the appliance is used in accordance with the factory directions, which accompany it, and on an Alternating current (AC) circuit.

How long does the coverage last?

This warranty runs for one year (1) from the purchase date found on your receipt and applies only to the original purchaser for use.

What is not covered by the warranty?

The warranty does not cover defects or damage of the appliance, which result from repairs or alterations to the appliance outside our factory or authorized service centers, nor shall it apply to any appliance, which has been subject to abuse, misuse, negligence or accidents. Also, consequential and incidental damage resulting from the use of this product or arising out of any breach of contract or breach of this warranty are not recoverable under this warranty. Some states do not allow the exclusion or limitation of incidental or consequential damage, so the above limitation may not apply to you.

How do you get service?

If repairs become necessary, see contact information below:

U.S. Residents:

Please contact our toll free hotline at **1-800-322-3848** or log onto our website at **www.delonghi.com**.

For all accessories, spare parts or replacement parts, please contact our parts division at **1-800-865-6330**.

Residents of Canada: Please contact our toll free hotline at **1-888-335-6644** or log onto our website at **www.delonghi.com**.

Residents of Mexico: Please refer to the Limited Warranty statement for Mexico. Please refer to the back page of the manual for De'Longhi addresses.

The above warranty is in lieu of all other express warranties and representations. All implied warranties are limited to the applicable warranty period set forth above. This limitation does not apply if you enter into an extended warranty with De'Longhi. Some states do not allow limitations on how long an implied warranty lasts, so the above exclusions may not apply to you. De'Longhi does not authorize any other person or company to assume for it any liability in connection with the sale or use of its