

This Owner's Manual is provided and hosted by [Appliance Factory Parts](http://www.ApplianceFactoryParts.com).

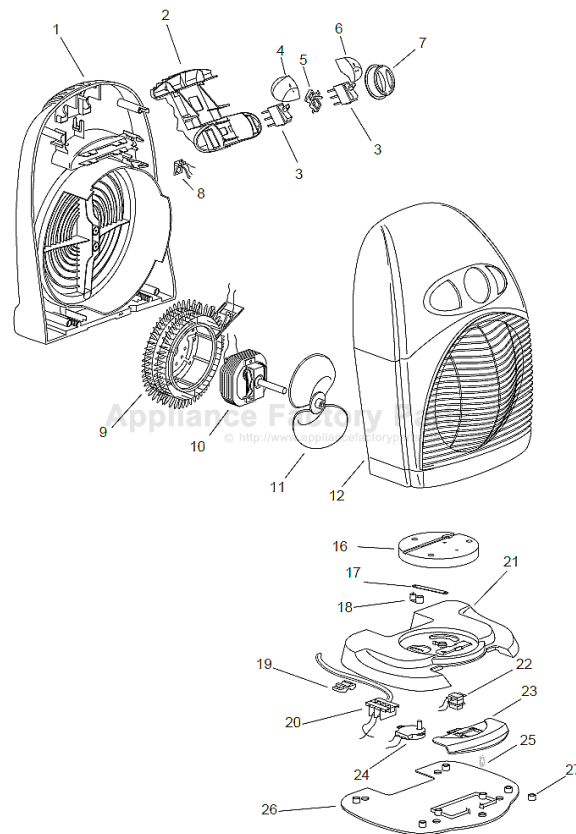

DE'LONGHI DFH450M W/G Owner's Manual

[Shop genuine replacement parts for DE'LONGHI
DFH450M W/G](#)



[Find Your DE'LONGHI HVAC Parts - Select From 166 Models](#)

----- Manual continues below -----

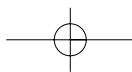

**OWNER'S INSTRUCTION
MODE D'EMPLOI
INSTRUCCIONES DE USO
MANUAL FÁCH**



**FAN HEATER
RADIATEUR SOUFLANT
TERMOVENTILADOR
TERMOVENTILADOR**

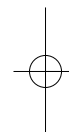
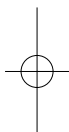

**READ AND SAVE THESE INSTRUCTIONS
LISEZ ET GARDEZ CES INSTRUCTIONS
REPASE Y GUARDE ESTAS INSTRUCCIONES
GUARDE ESTAS INSTRUÇÕES**

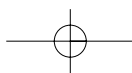



IMPORTANT SAFEGUARDS

When using electrical appliances, basic precautions should always be followed to reduce risk of fire, electric shock, and injury to persons, including the following:

1. Read all instructions before using the appliance.
2. This appliance is hot when in use. To avoid burns, do not let bare skin touch hot surfaces. Use handle when moving this heater. Keep combustible materials, such as furniture, pillows, bedding, papers, clothes and curtains at least 3 feet (0,9 m) from the front and top of the heater and keep them away from the sides and rear.
3. Extreme caution is necessary when any appliance is used by or near children or invalids and whenever the heater is left operating and unattended.
4. Always unplug appliance when not in use.
5. **Do not operate any appliance with a damaged cord or plug or after the appliance malfunctions, has been dropped or damaged in any manner. Return heater to authorized service facility for examination, electrical or mechanical adjustment, or repair.**
6. Do not use outdoors.
7. This heater is not intended for use in bathrooms, laundry areas and similar indoor locations. Never locate appliance where it may fall into a bathtub or other water container.
8. **Do not run cord under carpeting. Do not cover cord with throw rugs, runners, or the like. Arrange cord away from traffic area and where it will not be tripped over.**
9. To disconnect the appliance, turn controls to off, then remove plug from outlet.
10. Connect to properly polarized outlets only.
11. Do not insert or allow foreign objects to enter any ventilation opening as this may cause an electric shock, fire or damage the appliance.
12. To prevent a possible fire, do not block air intakes or exhaust in any manner. Do not use on soft surfaces, like a bed, where openings may become blocked.
13. **A fan heater has hot or arcing or sparking parts inside. Do not use it in areas where gasoline, paint, or flammable liquids are used or stored.**
14. Use this appliance only as described in this manual. Any other use not recommended by the manufacturer may cause fire, electric shock, or injury to persons.
15. To prevent overload and blown fuses, be sure that no other appliance is plugged into the same outlet (receptacle) or into another outlet (receptacle) wired into the same circuit.
16. It is normal for the heater's plug and cord to feel warm to the touch. A plug or cord which becomes hot to the touch or becomes distorted in shape may be a result of a worn electrical outlet (receptacle). Worn outlets or receptacles should be replaced prior to further use of the heater. Plugging heater into a worn outlet/receptacle/ may result in overheating of the power cord or fire.
17. **Do not use an extension cord because the extension cable may overheat and cause a risk of fire. However, if you have to use an extension cable, the cable shall be no. 14 AWG minimum size and rated not less than 1875 watts, and has to be used only for supplying power to this appliance.**
18. Be sure that the plug is fully inserted into an appropriate receptacle. Please remember that receptacles also deteriorate due to aging and continuous use: check periodically if

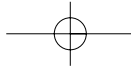

- signs overheating or deformations are evidenced by the plug. Do not use the receptacle and CALL your electrician.
19. Check that neither the appliance nor the power cable have been damaged in any way during transportation.
 20. **CAUTION:** to prevent electric shock match wide blade of plug to wide slot, fully insert.
 21. Do not cover the appliance while it is functioning in order to avoid overheating with the attendant risk of fire.

SAVE THESE INSTRUCTIONS

Your product is equipped with a polarized alternating current line plug (a plug having one blade wider than the other). This plug will fit into the power outlet only one way. This is a safety feature. If you are unable to insert the plug fully into the outlet, try reversing the plug. If the plug should still fail to fit, contact your electrician to replace your obsolete outlet. Do not defeat the safety purpose of the polarized plug.

CAUTION

- Always use the heater in an upright position.
- Do not use the heater to dry your laundry. Never obstruct the intake and outlet grilles (danger of overheating).
- The appliance must be installed so that the switches and other controls cannot be reached from a person standing in a bathtub or a shower.
- The electrical feed cord must be replaced only by officially authorised personnel.

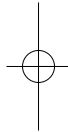
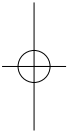

ELECTRIC CONNECTION

The fan heater must be connected to a properly polarized A/C 110/120 V household outlet in perfect working condition.

Keep loose clothing or bedding, furniture and flammable material away from the wall outlet where the heater is plugged in.

When you plug in the appliance, the red pilot light will illuminate (Fig. 1).

INSTALLATION

The fan heater can be easily positioned on any horizontal support surface in an upright position.

FAN HEATER CONTROLS:

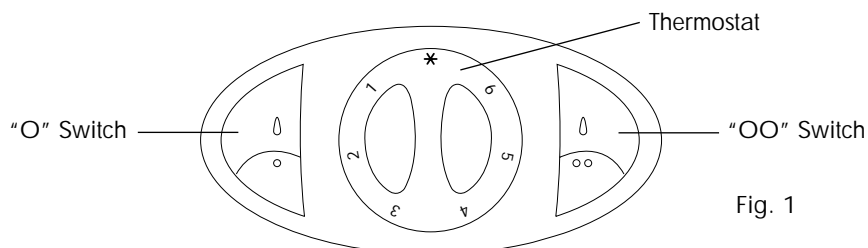
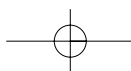

Fig. 1



OPERATION

- **Reduced power operation:** turn the thermostat dial to the maximum position and press the "o" switch (the pilot light will turn on).
- **Full power operation** (*only on some models*): turn the thermostat dial to the maximum position and press the "o" and "oo" switches (the pilot lights will turn on).
- **Setting the thermostat:**
When the room has reached the desired temperature, turn the thermostat knob slowly in an anti-clockwise direction until you get to the setting — and not beyond it — where you hear a click. The thermostat will then adjust that set temperature automatically and keep it constant.
You could utilize only one of them power during mild seasons and on days not particularly cold. You will thus use but little electrical power and obtain even greater savings in energy consumption.
- **Anti-freeze function**
With the thermostat in the ✖ position and the switches pressed, the appliance will keep the room at a temperature of approximately 5°C, thereby preventing freezing, at a minimum consumption of energy.
- **Switching the appliance off:** turn off the switches and turn the thermostat dial anti-clockwise to the minimum position ✖.

MODELS WITH ROTATING BODY

This appliance is fitted with a motorized base and a rotating body. To distribute the air flow over a larger area, press the oversized switch (Fig. 2). When activated, the appliance will oscillate from right to left over an angle of approximately 30°. To terminate oscillating, simply press the oversized switch again.

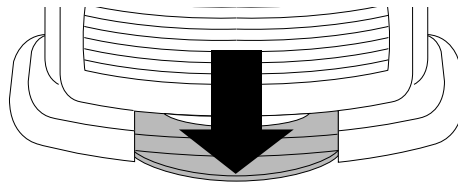

Fig. 2

IMPORTANT

In the event of a blackout, the appliance will not switch on again automatically. To switch the appliance back on, repeat the procedure described above.

MAINTENANCE AND SERVICE

Always remove the plug from the power socket and allow the heater to cool. After the heater has cooled, clean it with a soft damp cloth, do not use detergents or abrasives. Periodically clean the air intake and outlet grilles during the period in which the heater is in use with a vacuum cleaner.

Should the heater not be in use over a certain length of time, store it in a dry place.

This appliance has been built to provide many years of trouble free service.

In case of malfunction, do not try to repair the heater yourself: it may result in fire hazard or electric shock. Call the nearest Service Center (see attached list of Service Centers).

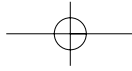

ATTENTION

A safety device switches the fan heater off if it accidentally overheats. An audible signal warns of any problems. To reset the unit for normal operation, remove the plug from the mains socket for a few minutes, eliminate the cause of overheating (e.g. air intake or outlet grilles obstructed) and then plug the fan heater back in again. Contact your nearest Service Center if the fan heater does not begin normal operation again.



LIMITED WARRANTY

What Does This Warranty Cover? We warrant each appliance to be free from defects in material and workmanship. Our obligation under this warranty is limited to replacement or repair, free of charge at our factory or authorized service centers, of any defective part or parts thereof other than parts damaged in transit, which shall be returned to us, transportation prepaid. This warranty shall apply only if the appliance is used in accordance with the factory directions which accompany it, and on an Alternating Current (AC) circuit.

How Long Does The Coverage Last? This warranty runs for one year from the date of delivery and applies only to the original purchaser for use.

What Does This Warranty Not Cover? This warranty does not cover defects or damage of the appliance which result from repairs or alterations to the appliance outside our factory or authorized service centers, nor shall it apply to any appliance which has been subject to abuse, misuse, negligence or accidents. Also, consequential and incidental damages resulting from the use of this product or arising out of any breach of contract or breach of this warranty are not recoverable under this warranty. Some states do not allow the exclusion or limitation of incidental or consequential damages, so the above limitation may not apply to you.

How Do You Get Service? If repairs become necessary or spare parts are needed, please write to:

DE' LONGHI AMERICA INC.
Park 80 West Plaza One, 4th floor
Saddle Brook, NJ 07663
or call Service Tel. No. 1-800-322-3848
or visit our internet site www.delonghiusa.com

The above warranty is in lieu of all other express warranties and representations. All implied warranties are limited to the applicable warranty period set forth above. This limitation does apply if you enter into an extended warranty with De' Longhi. Some states do not allow limitations on how long an implied warranty lasts, so the above exclusions may not apply to you. De' Longhi does not authorize any other person or company to assume for it any liability in connection with the sale or use of its appliance.

How Does State Law Apply? This warranty gives you specific legal rights, and you may also have other rights which vary from state to state.

