

This Owner's Manual is provided and hosted by [Appliance Factory Parts](#).



Broil King 543-34 Owner's Manual

[Shop genuine replacement parts for Broil King 543-34](#)



[Find Your Broil King Grill Parts - Select From 1348 Models](#)

----- Manual continues below -----

Broil King®

REDDI-BILT BARBECUES

ASSEMBLY MANUAL & PARTS LIST

MANUEL DE MONTAGE & LISTE DE PIÈCES

Broil King
MONARCH 10
543-14
543-17



Broil King
MONARCH 20
543-24
543-27



Broil King
MONARCH 30
543-34
543-37

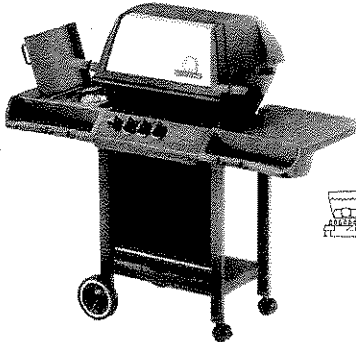

Broil King
MONARCH 40
543-44
543-47

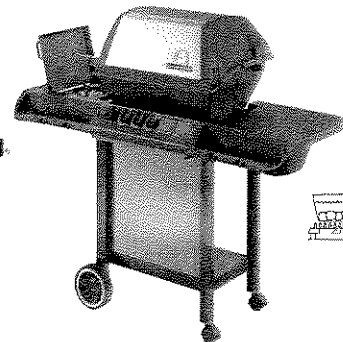

Broil King
MONARCH 70
543-74
543-77

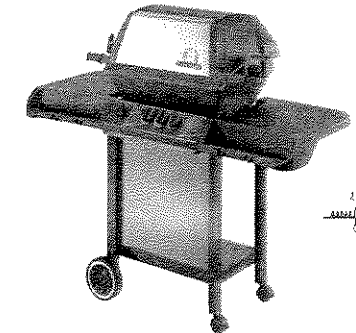

Broil King
CROWN 20
944-24
944-27

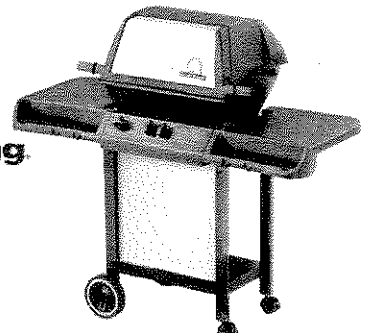

Broil King
CROWN 40
944-44
944-47

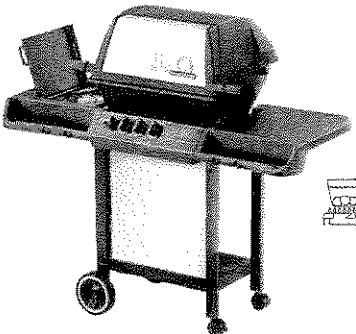

Broil King
CROWN 70
944-74
944-77

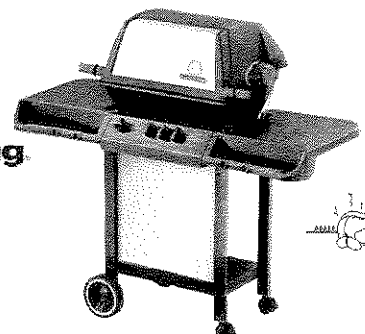

RETAIN FOR FUTURE REFERENCE
ULTÉRIEURE

VEUILLEZ CONSERVER POUR REFERENCE

1-800-265-2150

Onward
MANUFACTURING COMPANY
SINCE 1906
585 KUMPF DRIVE
WATERLOO, ONTARIO, CANADA
N2Y 1K3
LIMITED

info@omcbbq.com

10084-T43 REV F 11/05

1

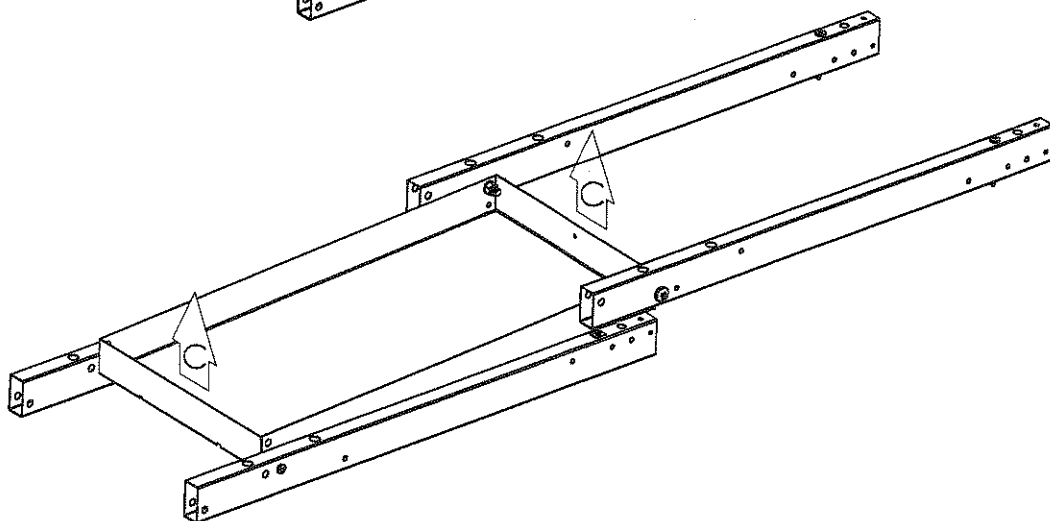
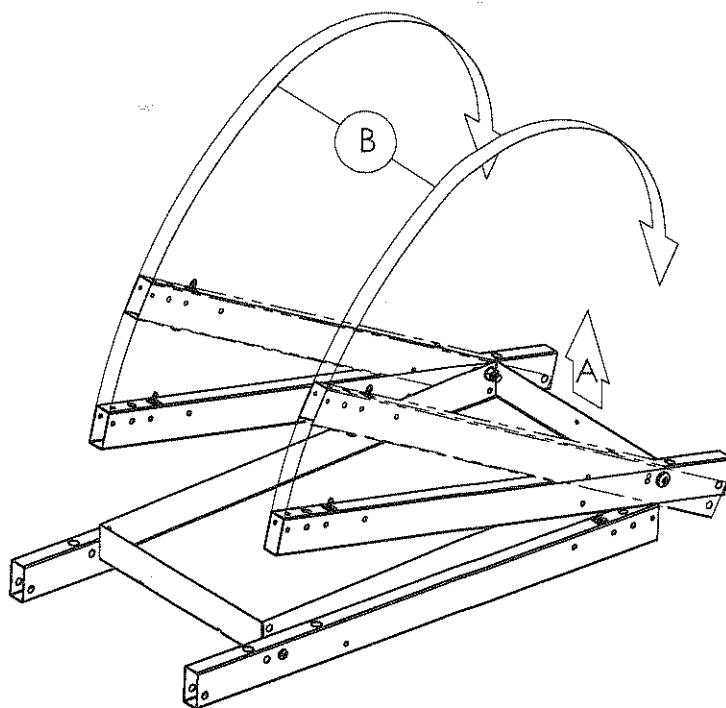
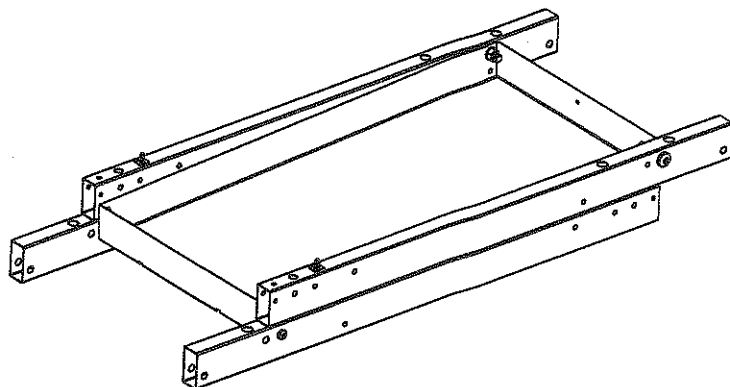

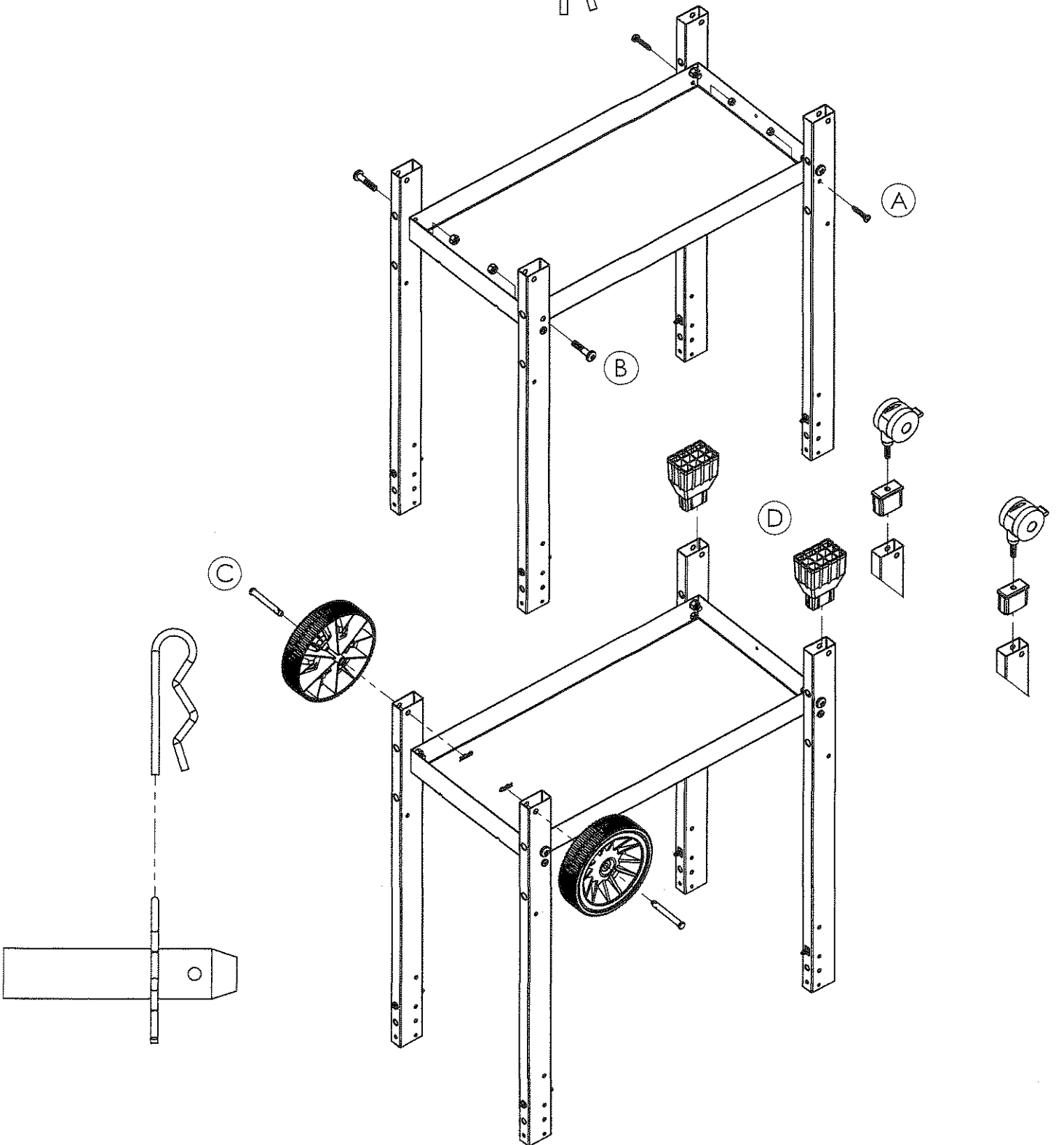
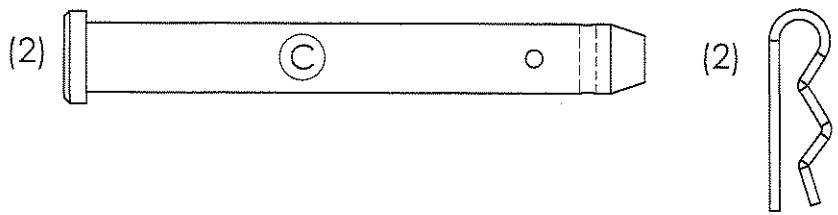
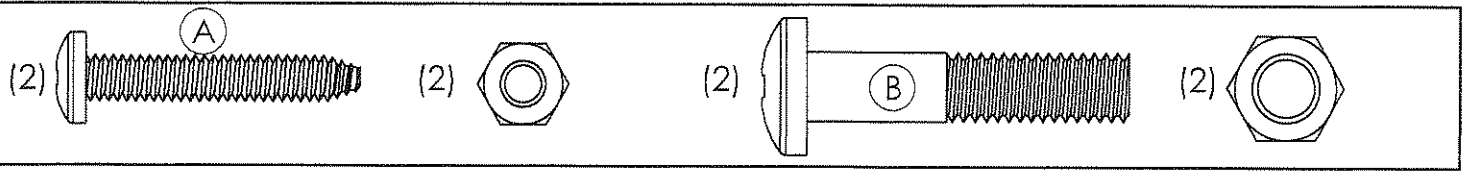

2

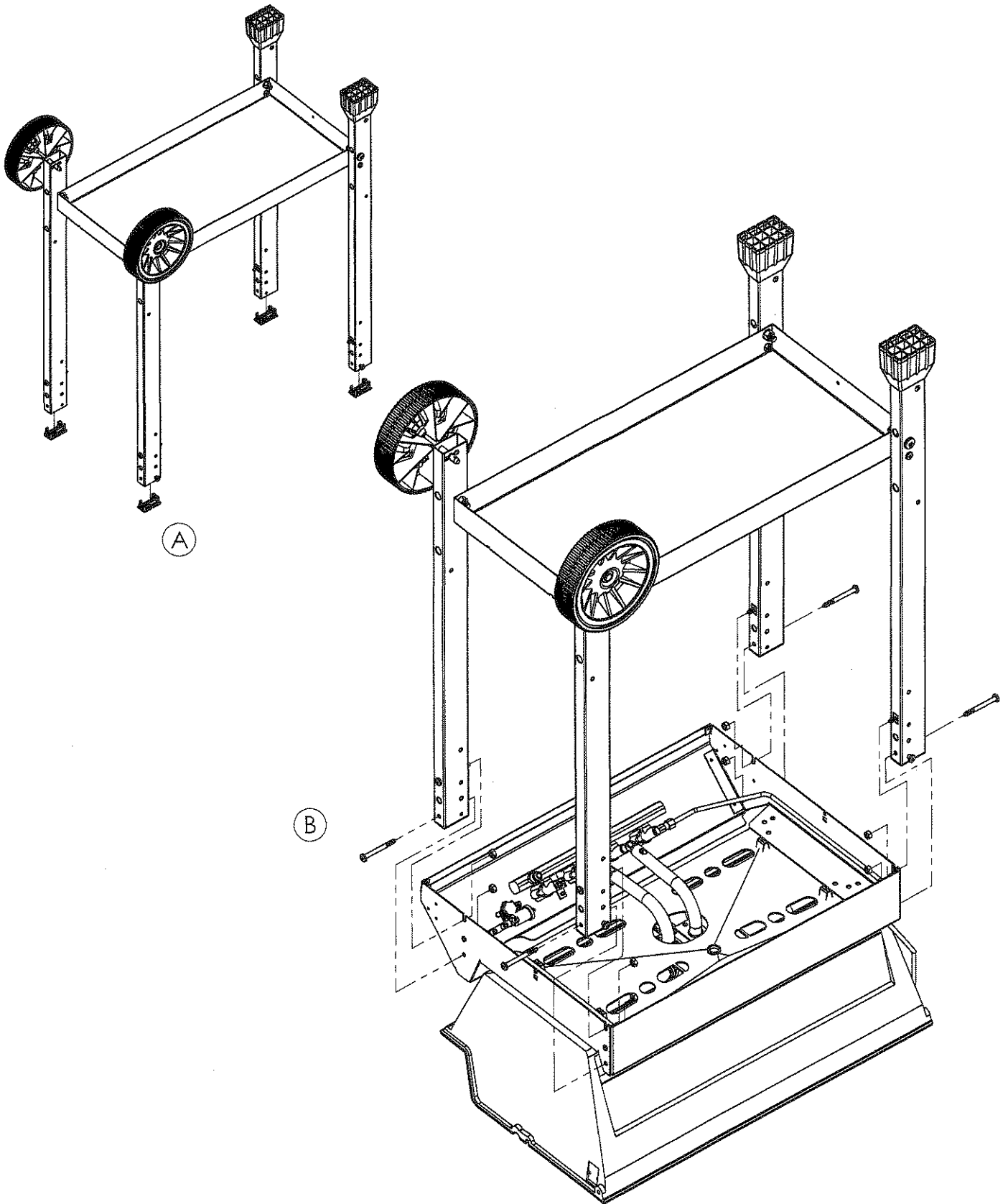
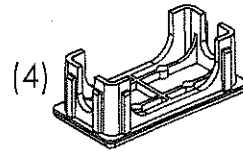
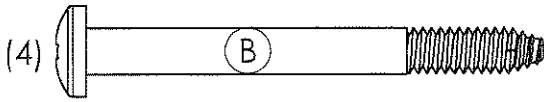

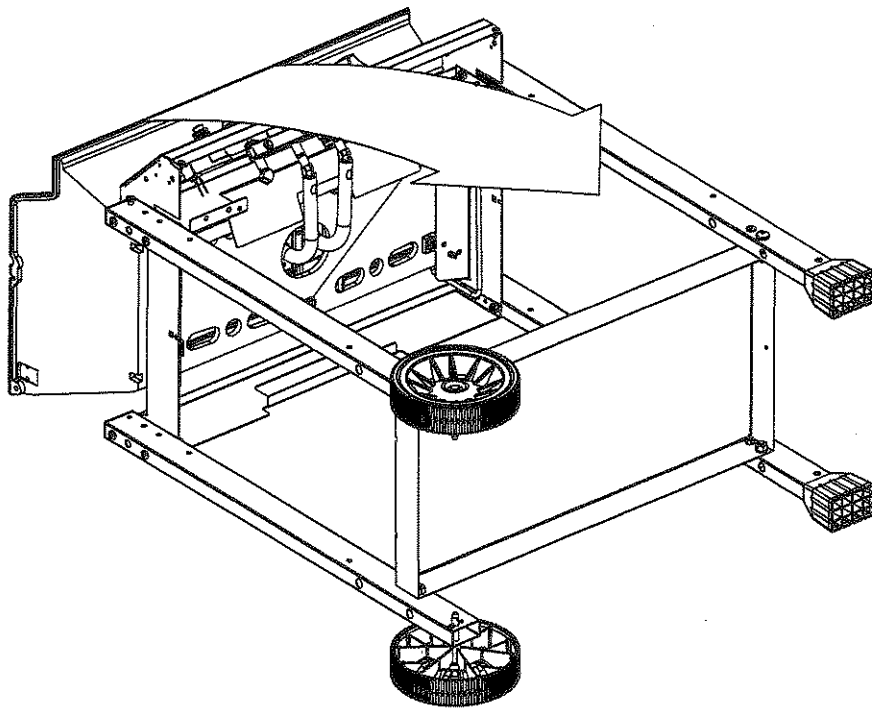
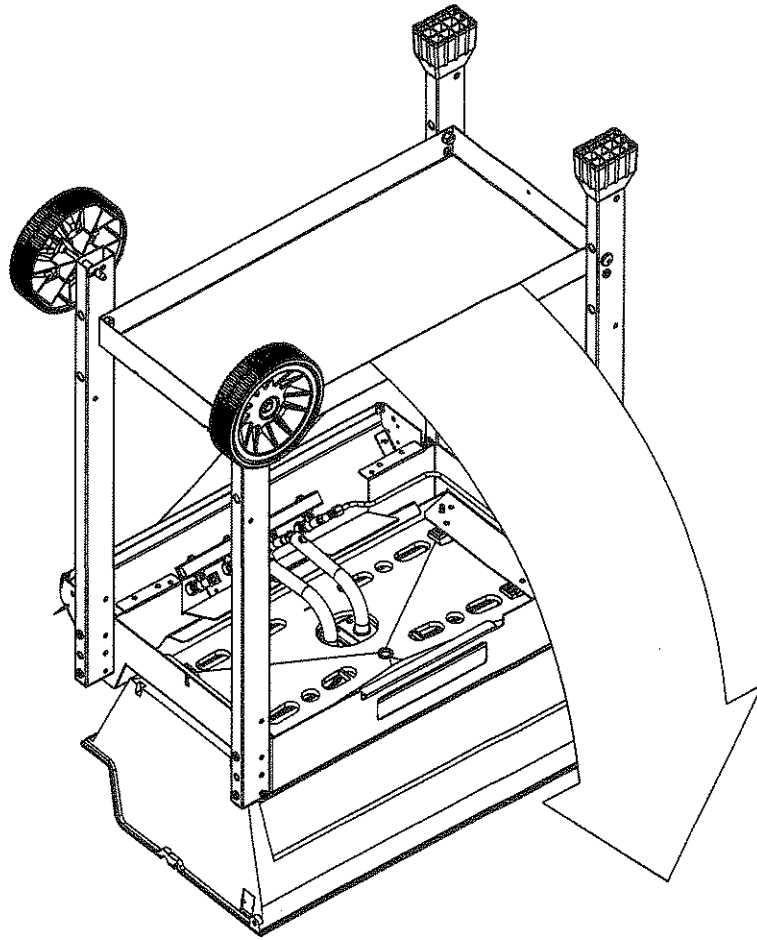

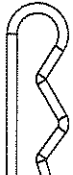
3	(2)  (2)	
----------	---	--

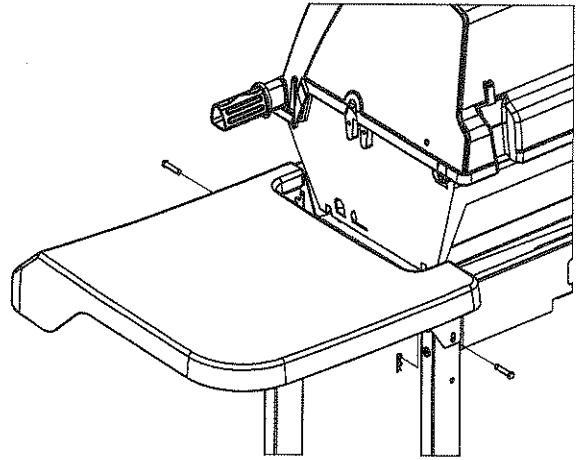
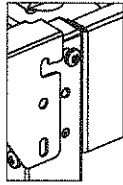
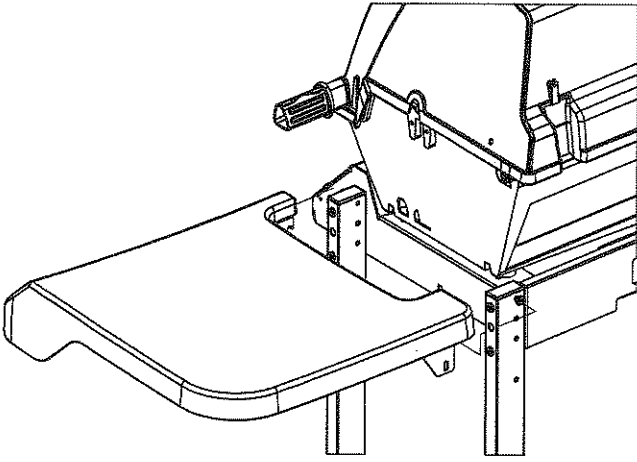

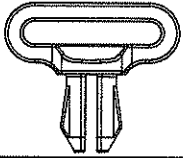
4	(1) 	
----------	---	--

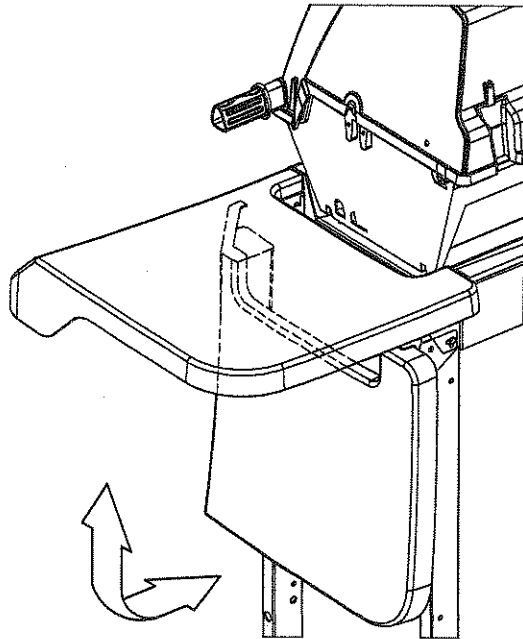
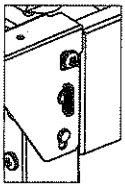
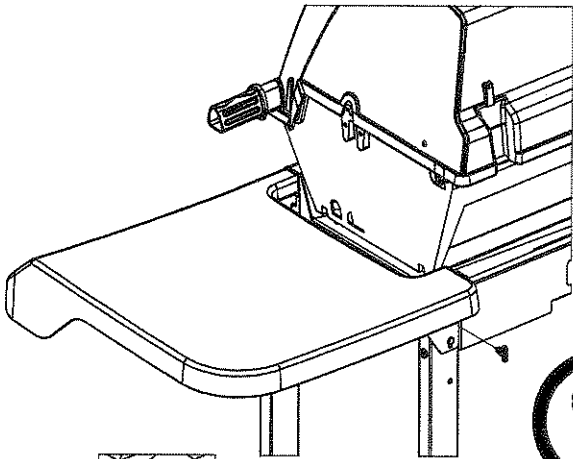

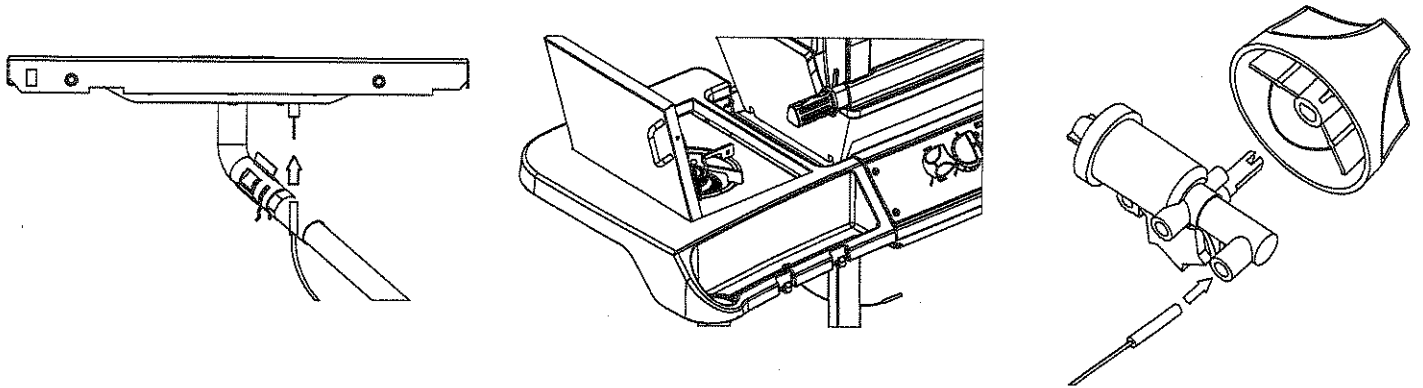
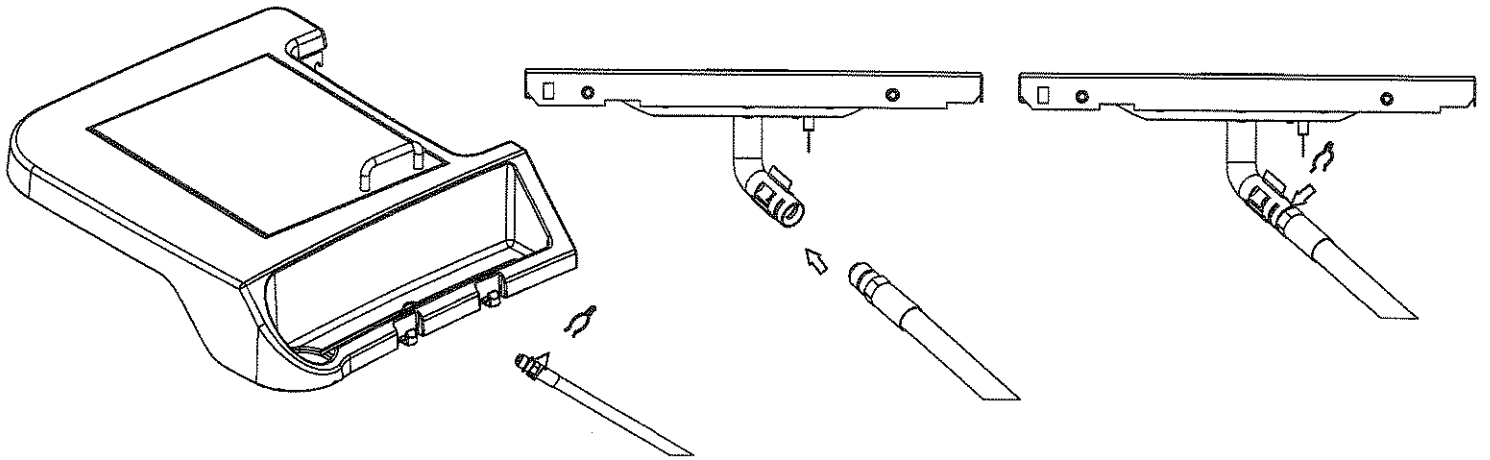
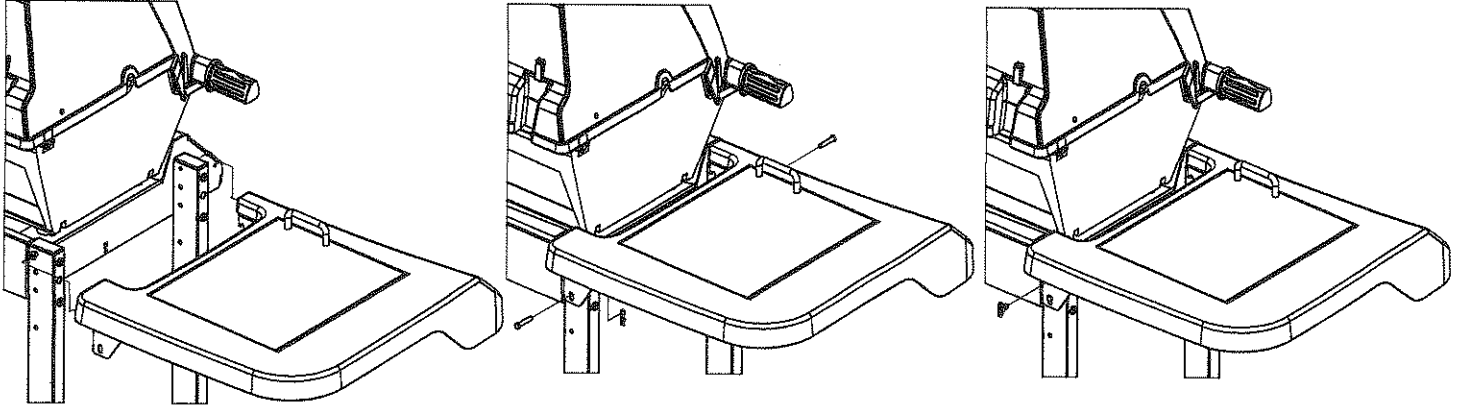
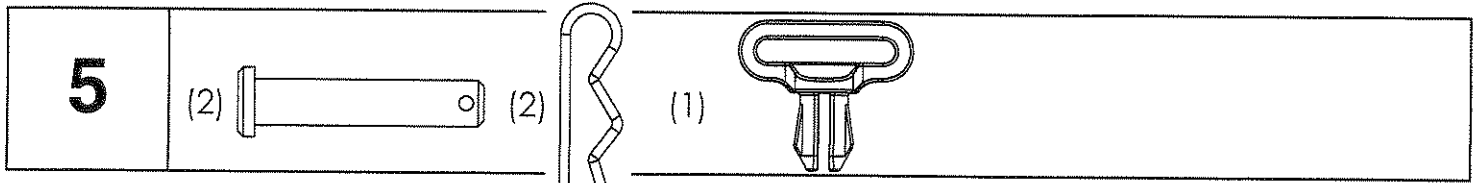

7

(2) (A) (2)



(2) (B) (2)

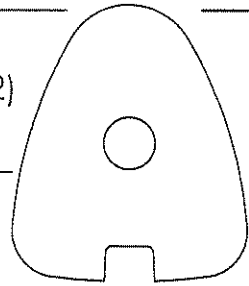

(2)

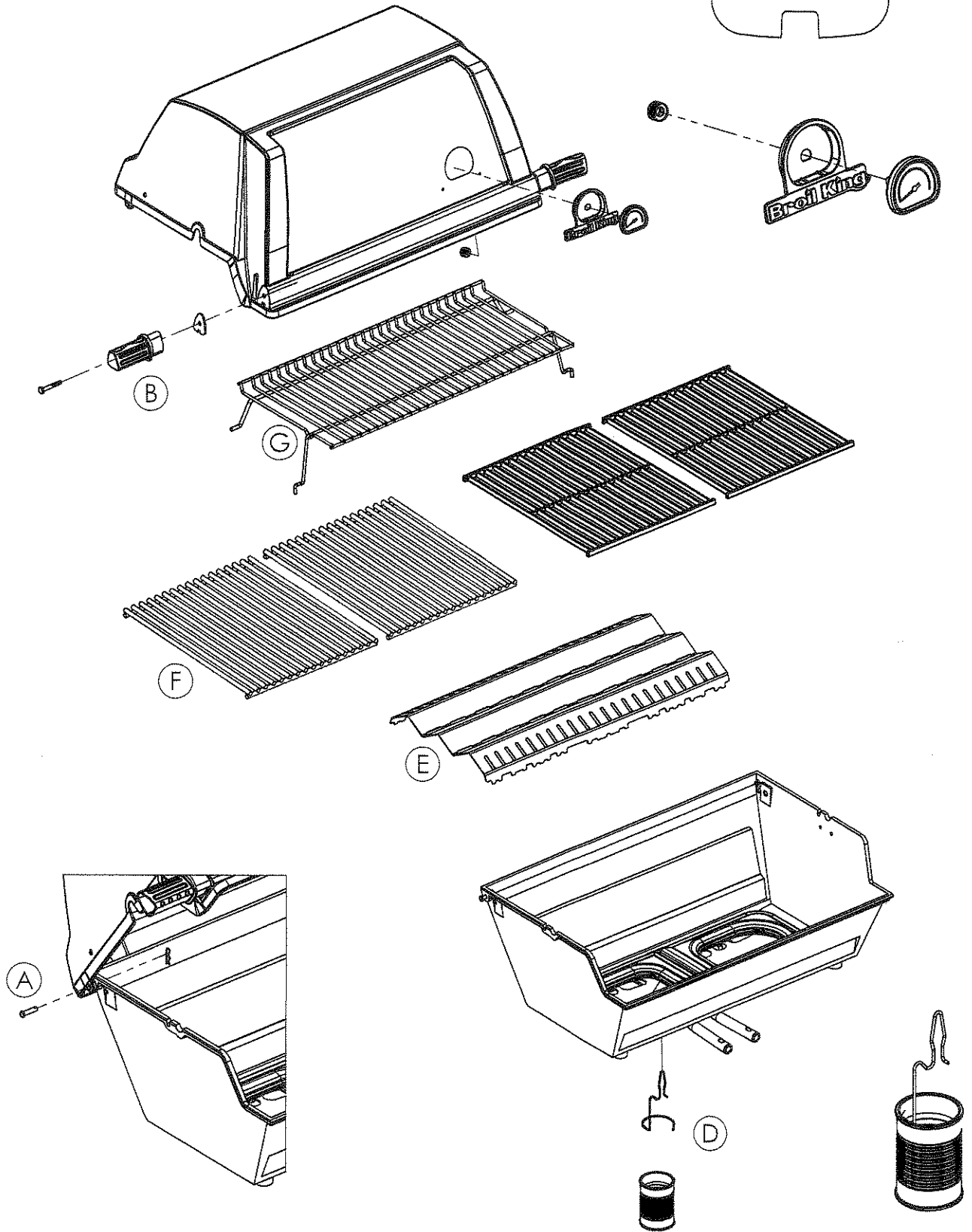

8

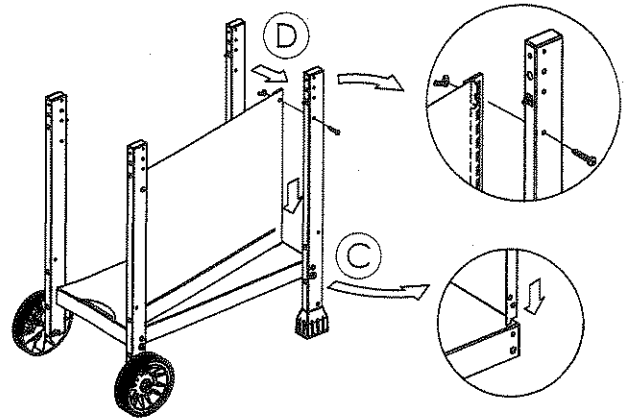
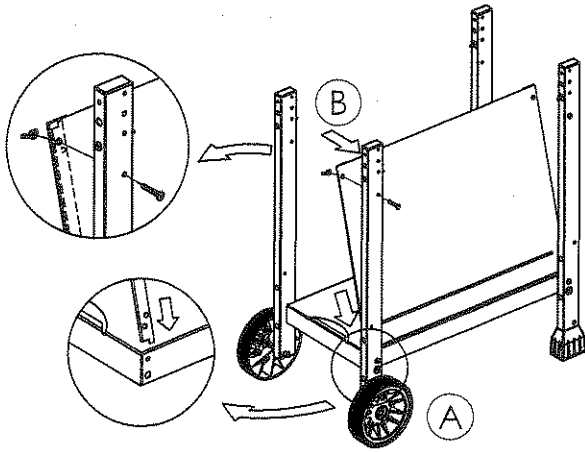
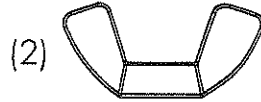
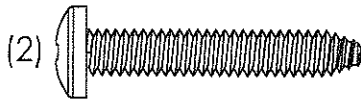

9

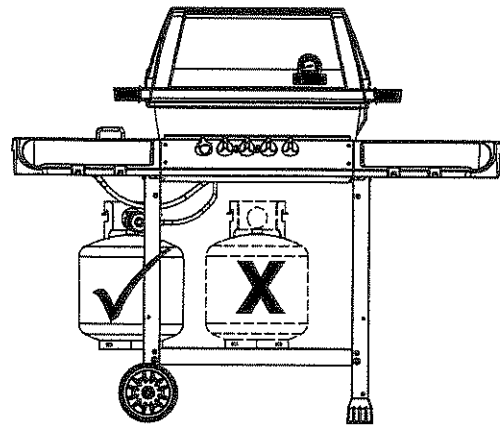
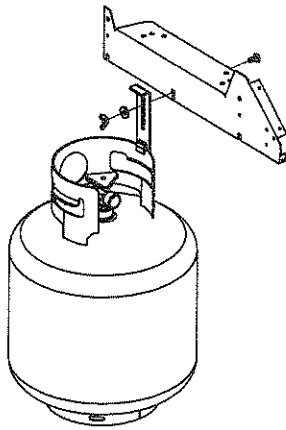
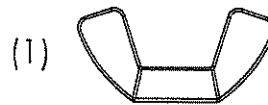
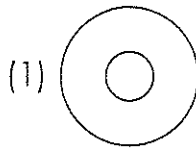
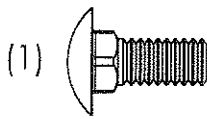

10

