

This Owner's Manual is provided and hosted by [Appliance Factory Parts](#).



# Broil King 543-74 Owner's Manual

[Shop genuine replacement parts for Broil King 543-74](#)



[Find Your Broil King Grill Parts - Select From 1348 Models](#)

----- Manual continues below -----

# Broil King®

REDDI-BILT BARBECUES

ASSEMBLY MANUAL & PARTS LIST

MANUEL DE MONTAGE & LISTE DE PIÈCES

**Broil King**  
MONARCH 10  
543-14  
543-17



**Broil King**  
MONARCH 20  
543-24  
543-27



**Broil King**  
MONARCH 30  
543-34  
543-37

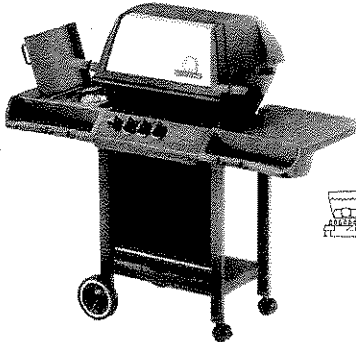

**Broil King**  
MONARCH 40  
543-44  
543-47

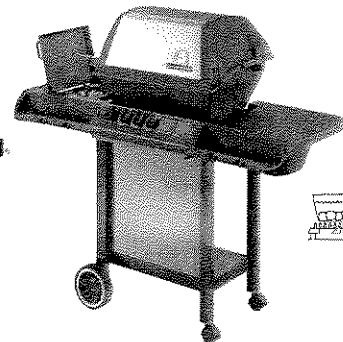

**Broil King**  
MONARCH 70  
543-74  
543-77

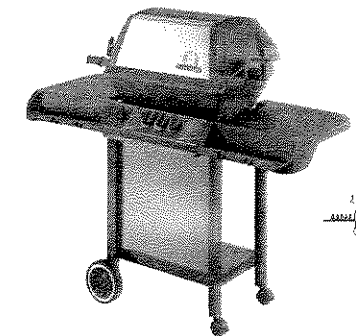

**Broil King**  
CROWN 20  
944-24  
944-27

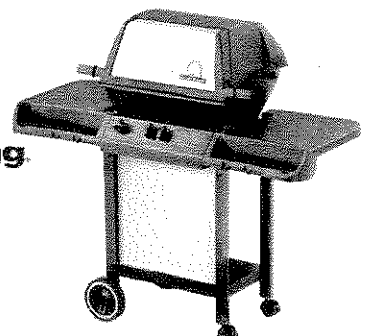

**Broil King**  
CROWN 40  
944-44  
944-47

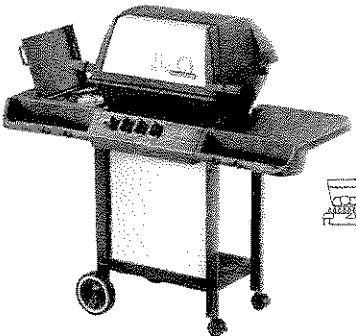

**Broil King**  
CROWN 70  
944-74  
944-77

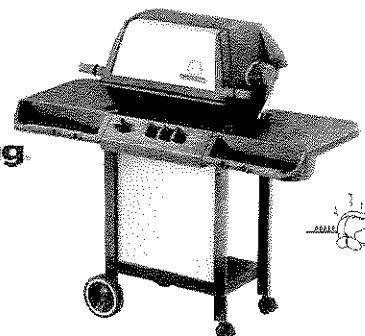

RETAIN FOR FUTURE REFERENCE  
ULTÉRIEURE

VEUILLEZ CONSERVER POUR REFERENCE

1-800-265-2150

*Onward*  
MANUFACTURING COMPANY  
SINCE 1906  
585 KUMPF DRIVE  
WATERLOO, ONTARIO, CANADA  
N2Y 1K3  
LIMITED

info@omcbbq.com

10084-T43 REV F 11/05

1

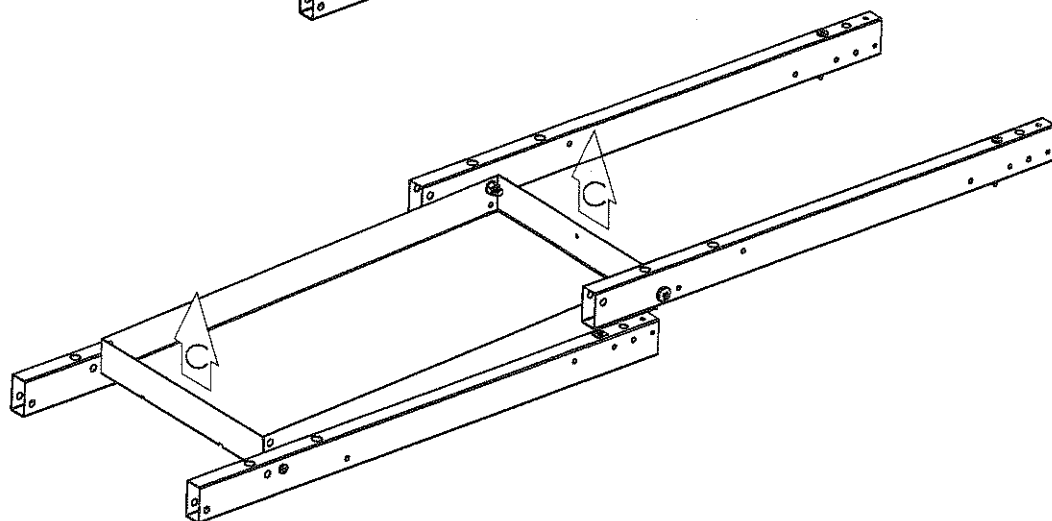
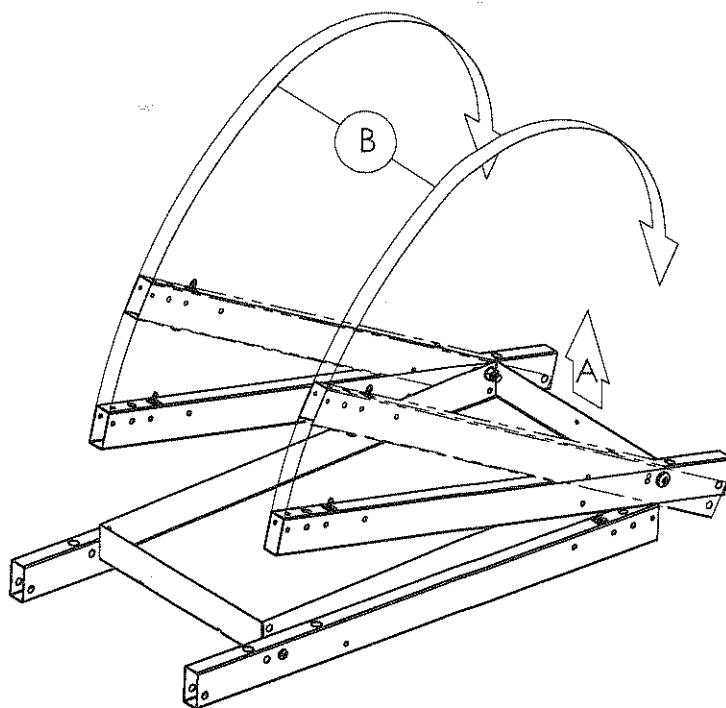
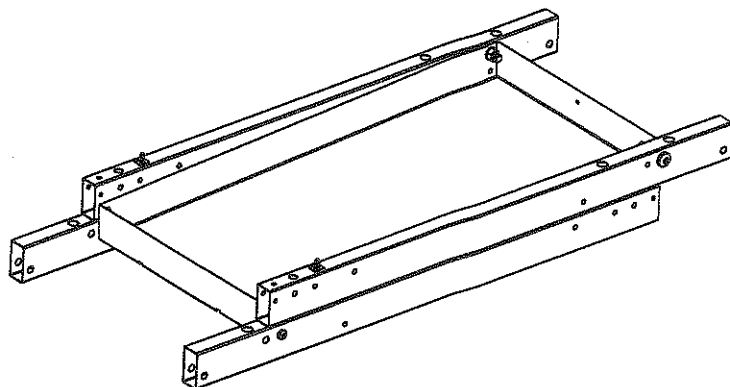

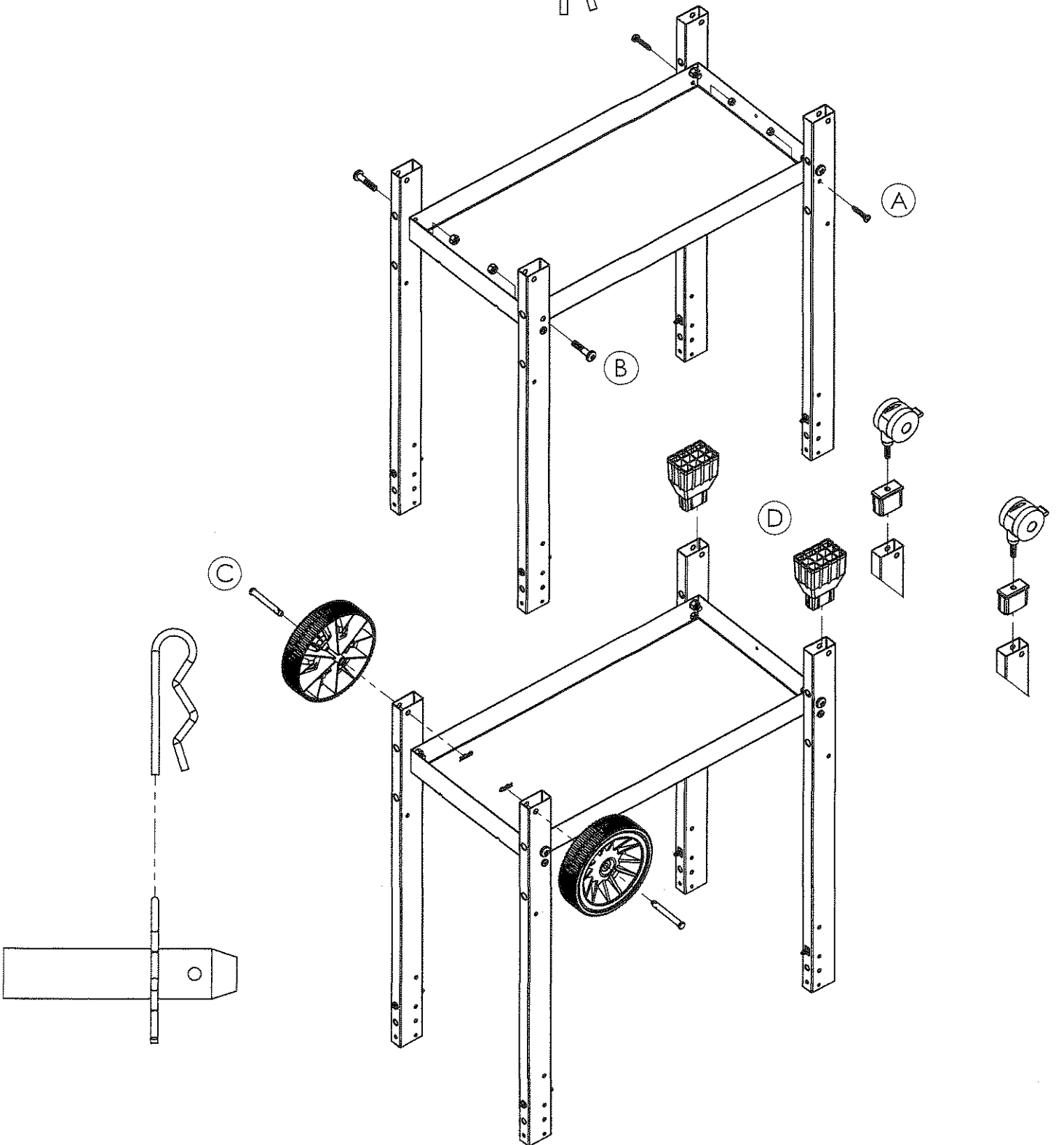
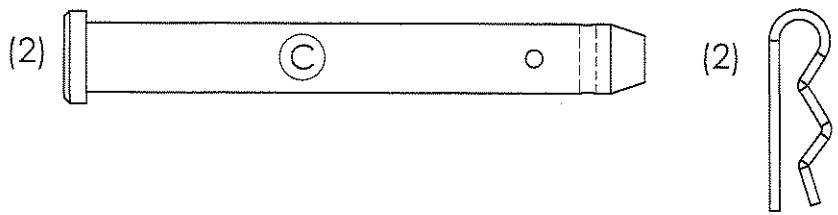
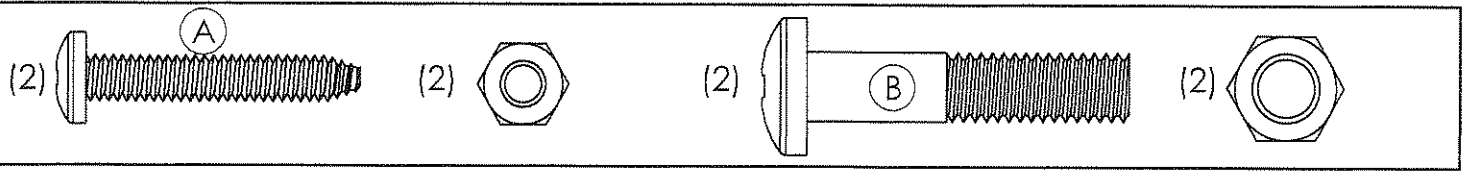

2

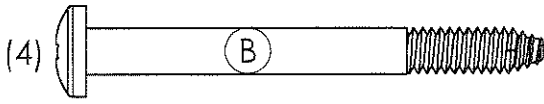

(4)

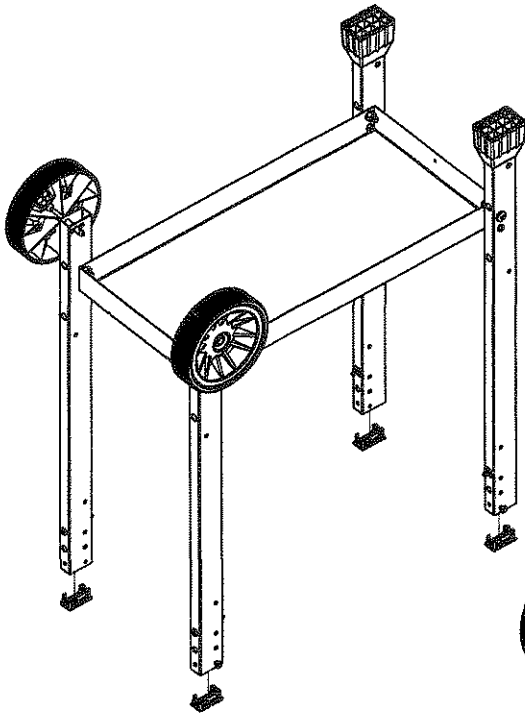
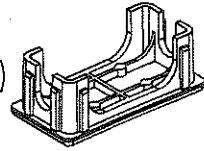

(A)

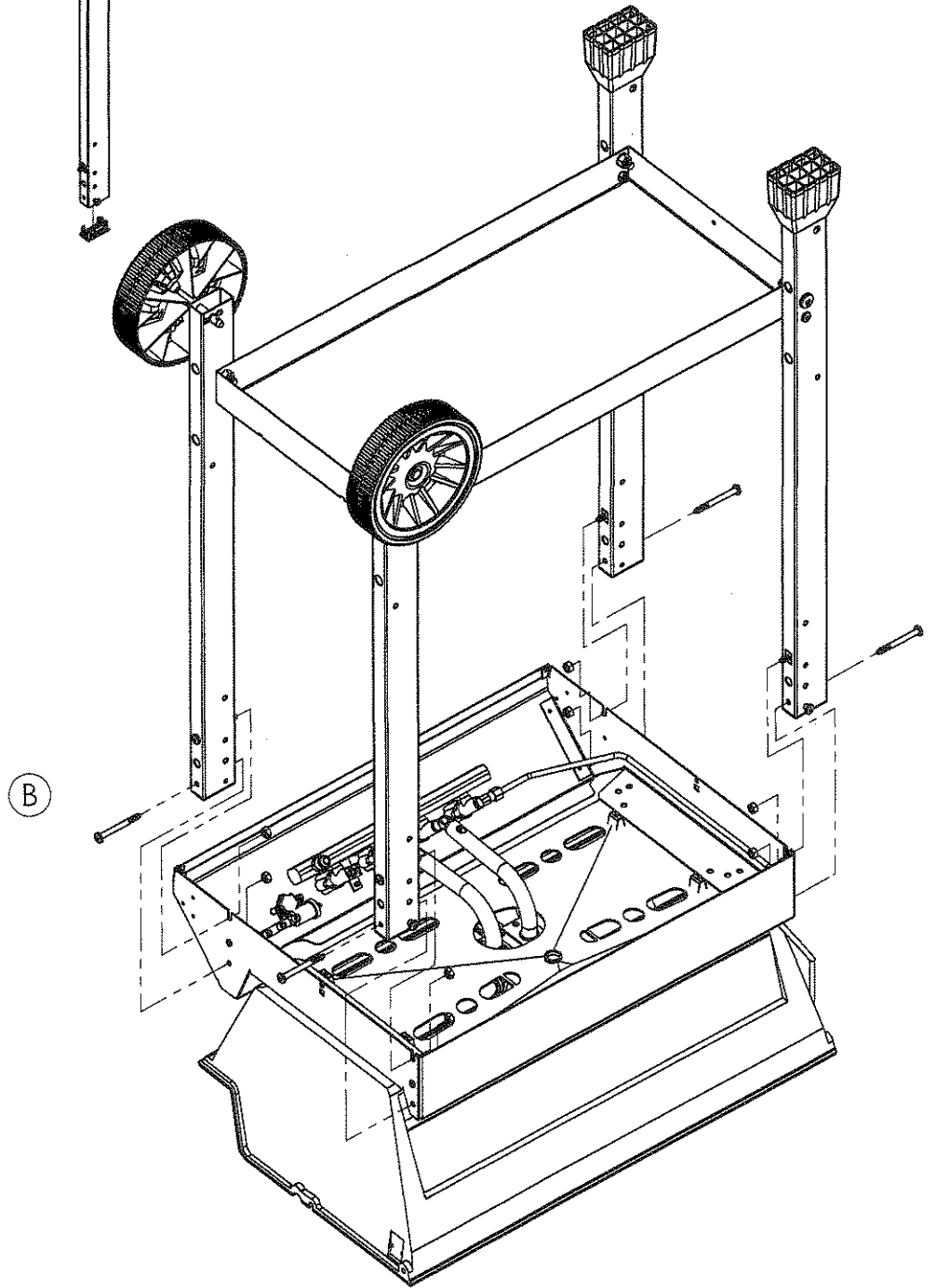

(B)

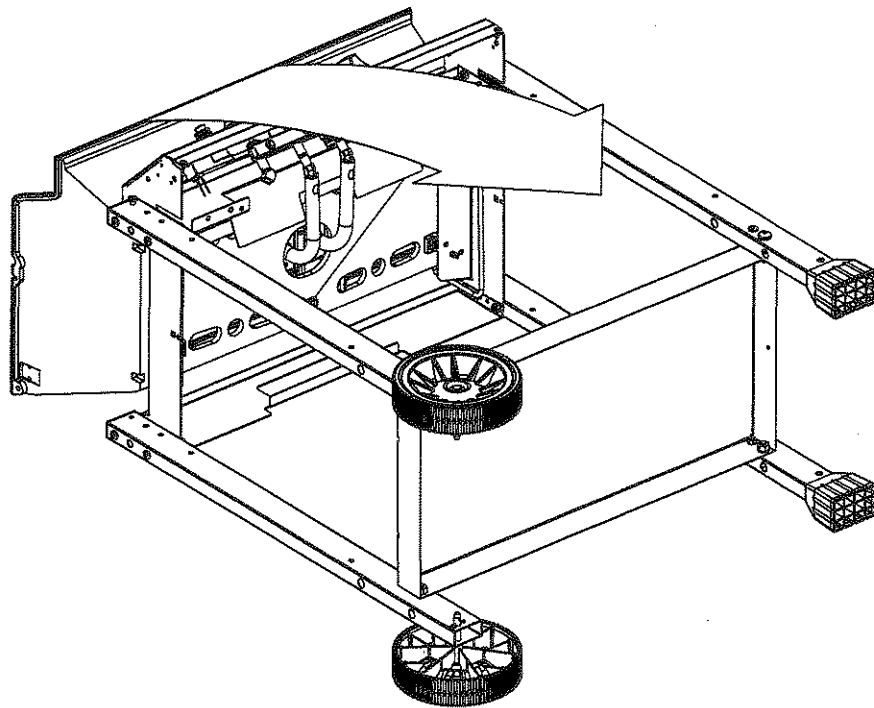
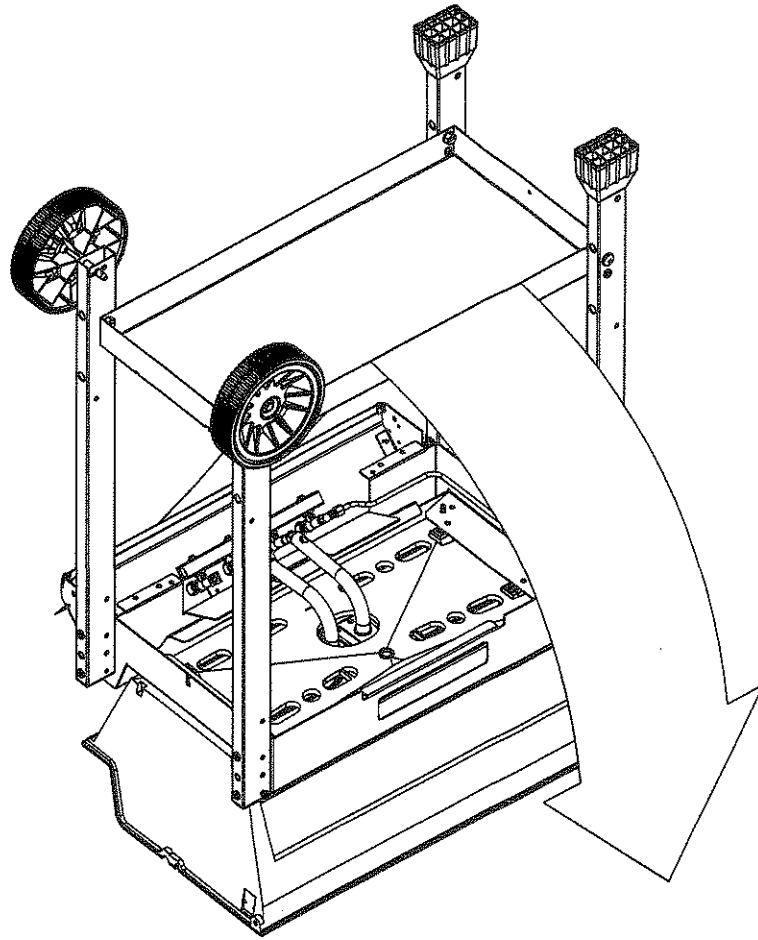

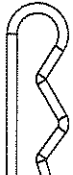
<b>3</b>	(2)  (2)	
----------	---	--

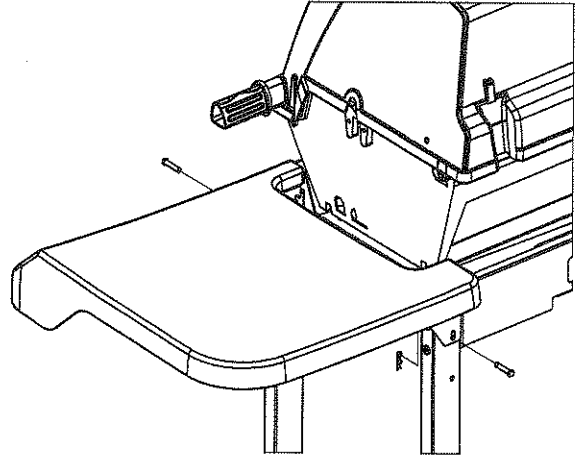
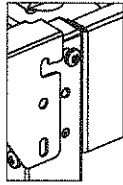
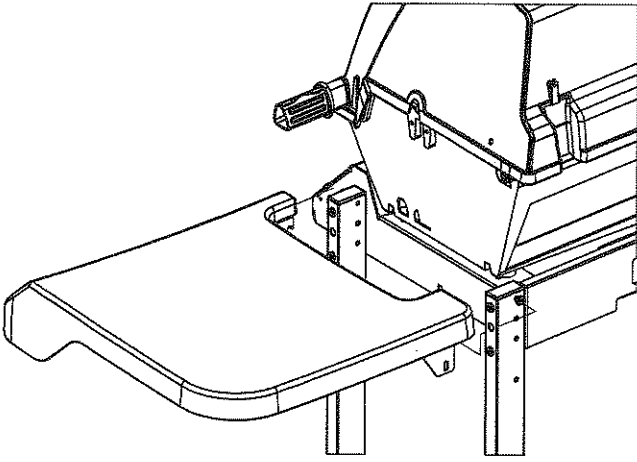

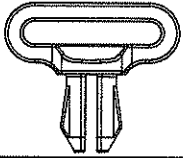
<b>4</b>	(1) 	
----------	---	--

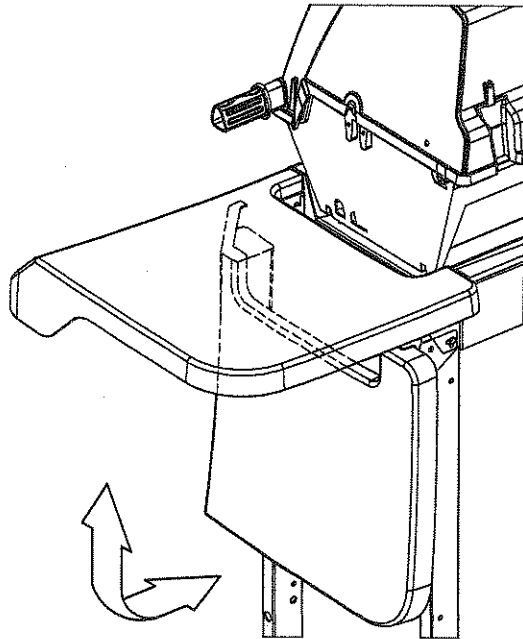
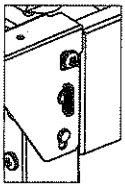
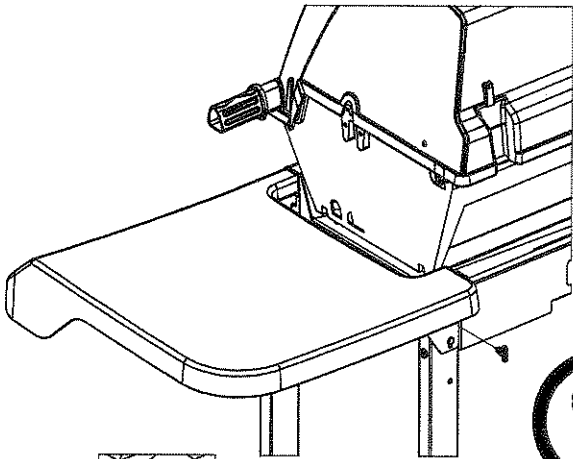

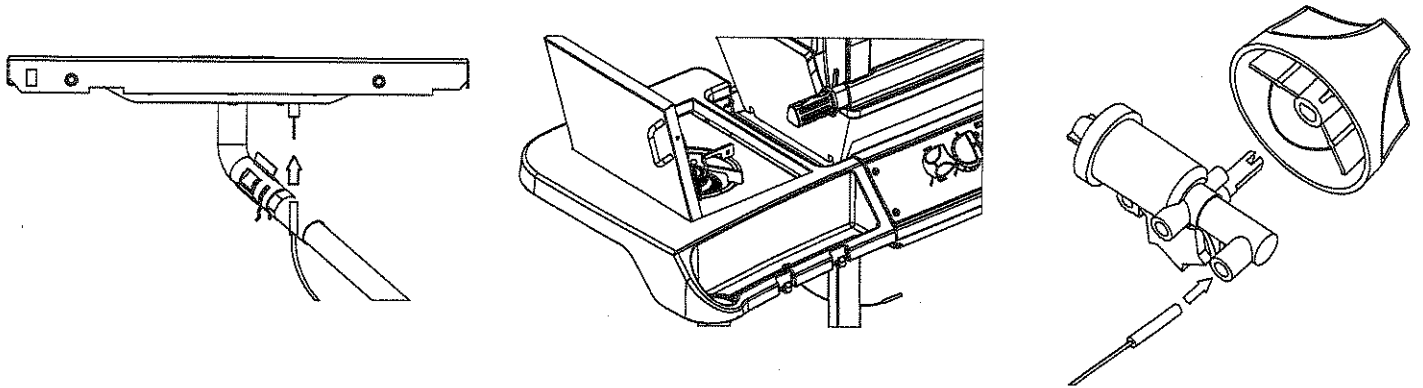
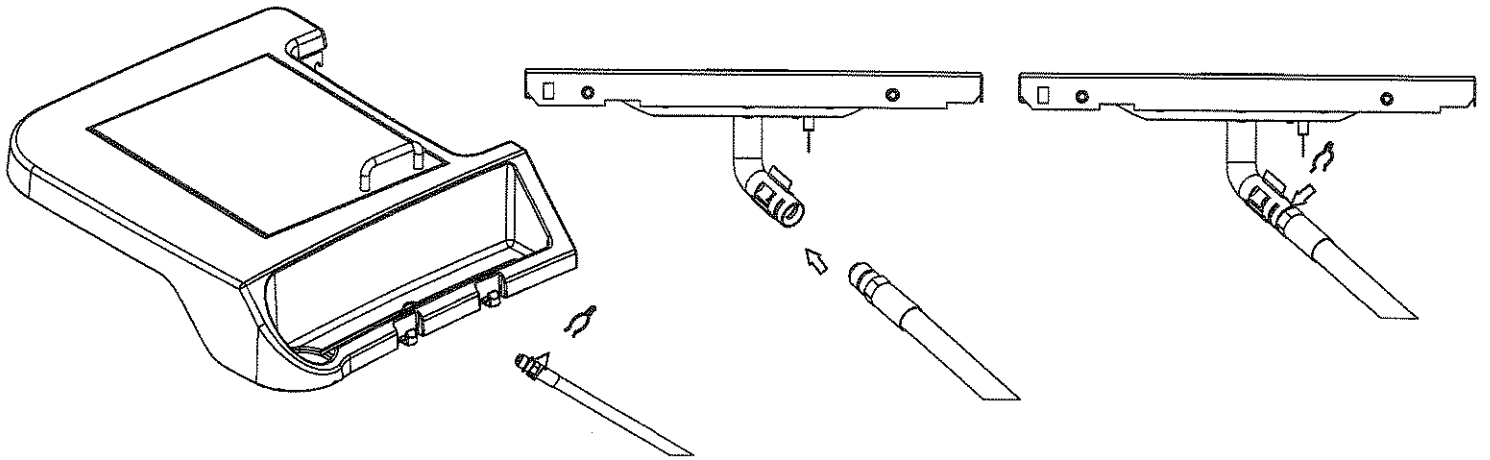
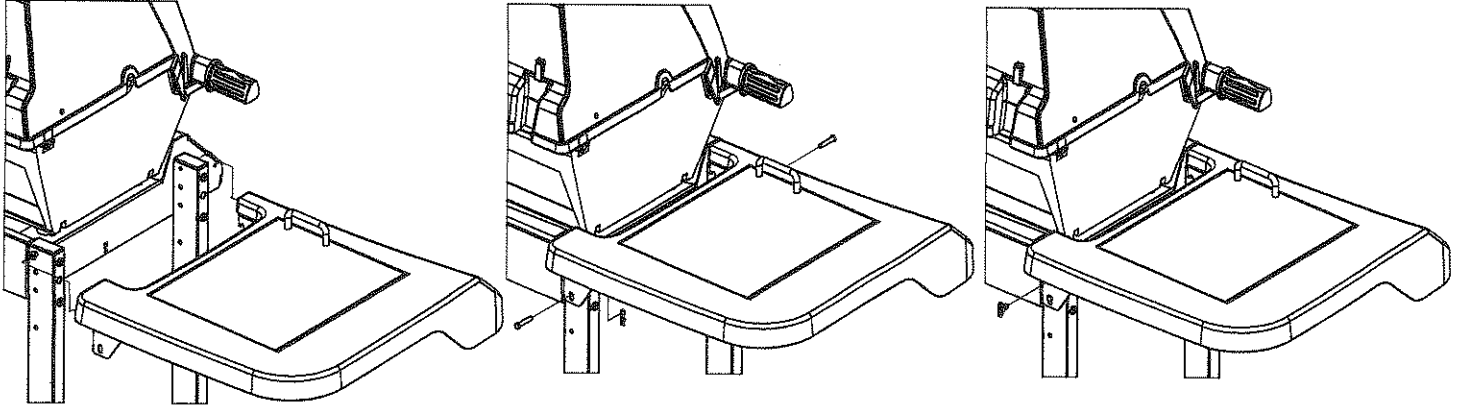
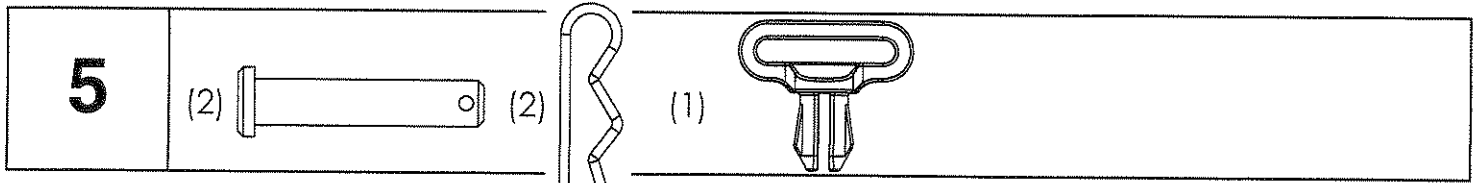

7

(2) (A) (2)



(2) (B) (2)

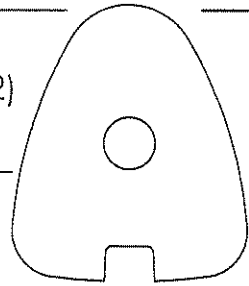

(2)

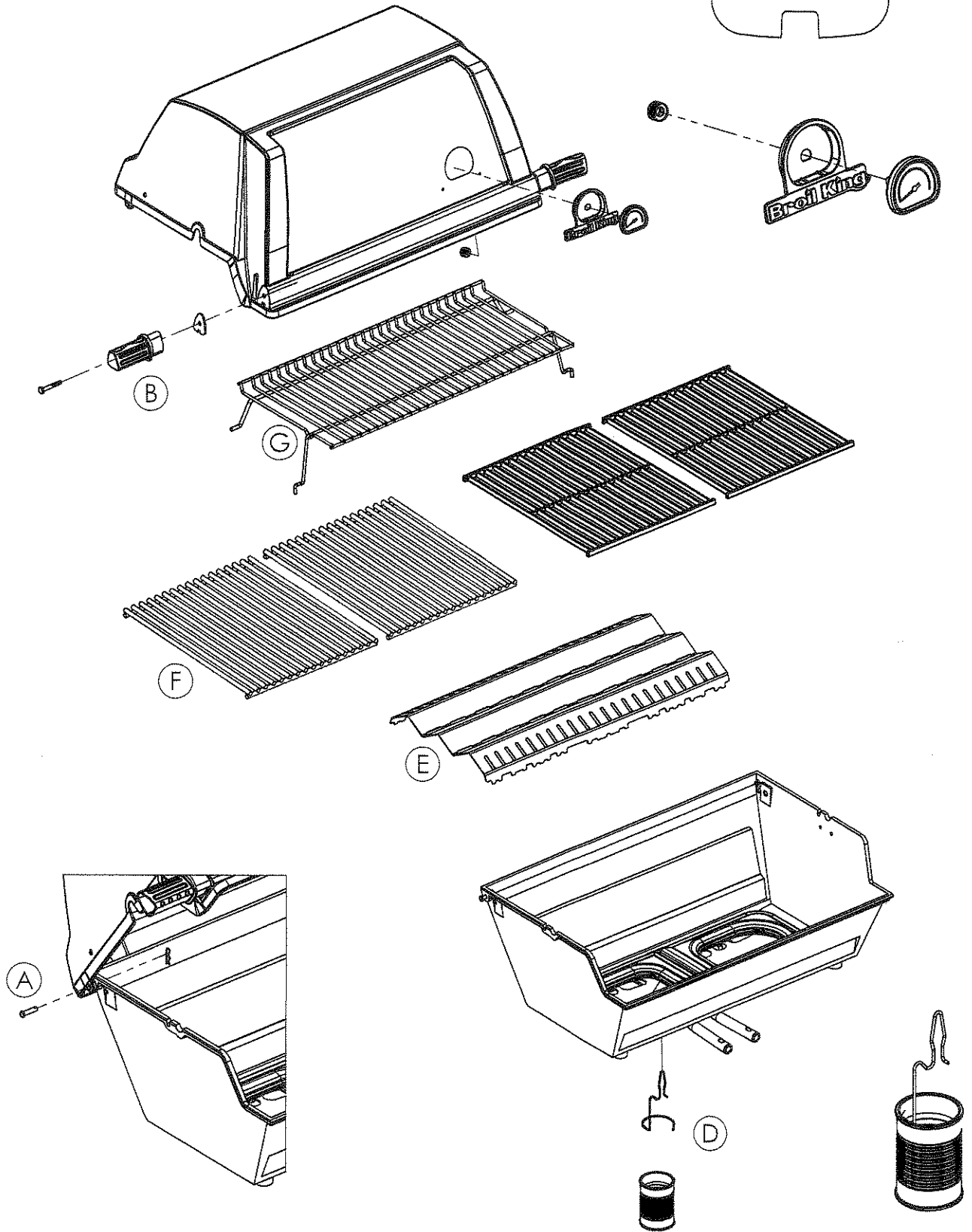

8

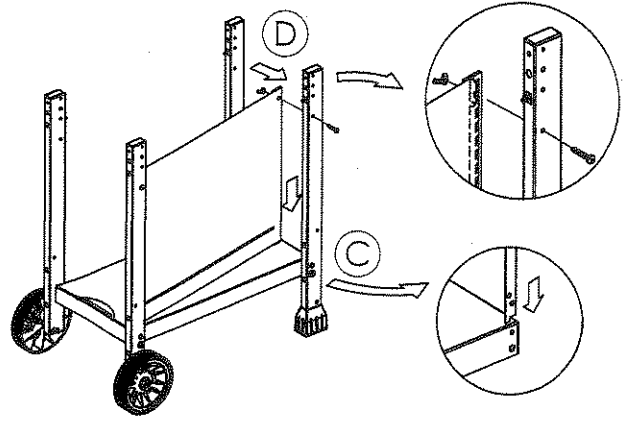
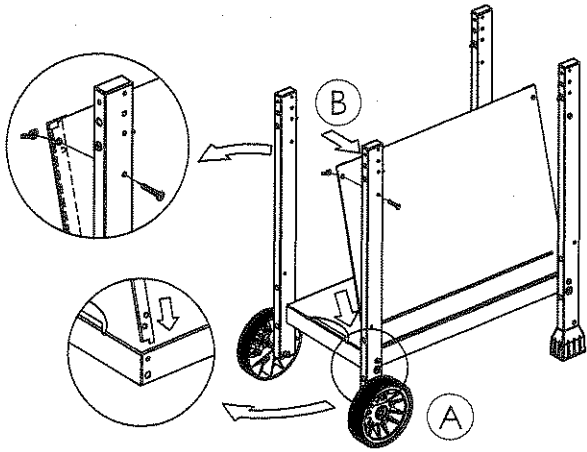
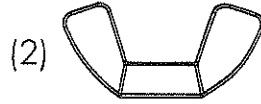
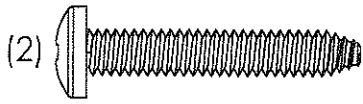

9

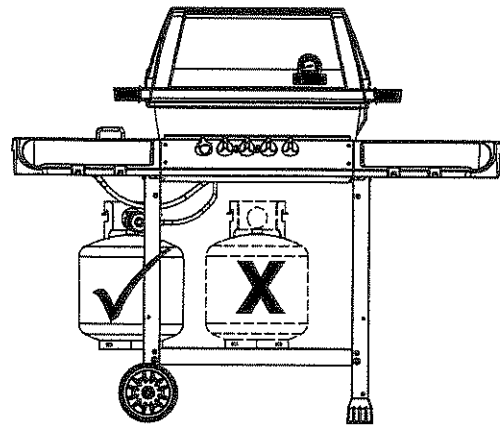
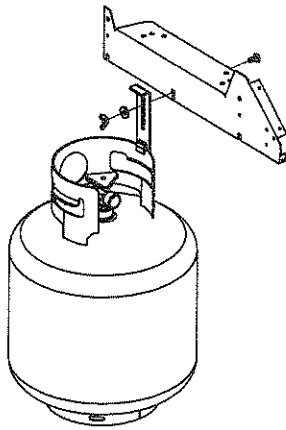
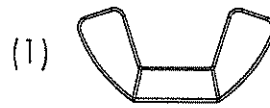
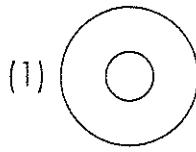
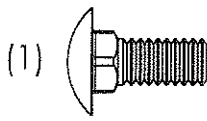

10

