

This Owner's Manual is provided and hosted by [Appliance Factory Parts](#).



DAYTON 1DXG6 Owner's Manual

[Shop genuine replacement parts for DAYTON 1DXG6](#)



[Find Your DAYTON Dehumidifier Parts - Select From 9 Models](#)

----- Manual continues below -----

Please read and save these instructions. Read carefully before attempting to assemble, install, operate or maintain the product described. Protect yourself and others by observing all safety information. Failure to comply with instructions could result in personal injury and/or property damage! Retain instructions for future reference.

Dayton® Dehumidifiers

Description

Dayton 30, 45, and 65 pint dehumidifiers are rugged and compact to provide dependable trouble-free service. A hose adapter is included for optional permanent floor drain installation. Features include a "Full" indicator light, "Power" indicator light, and humidistat control.

MODEL 1DGX4



Figure 1

MODELS 1DGX5 AND 1DGX6

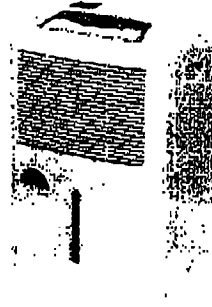

Figure 2



Specifications

Capacity*	30 pints per day (1DGX4), 45 pints per day (1DGX5), 65 pints per day (1DGX6)
Power Supply	115 V, 60 Hz, AC Only, 1 Phase
Amps	4.5 (1DGX4), 5.2 (1DGX5), 6.8 (1DGX6)
Power Consumption	390 W (1DGX4), 620 W (1DGX5), 780 W (1DGX6)
Operating Ambient	
Temperature Range	42 to 105°F (1DGX4, 1DGX5, 1DGX6)
Relative Humidity Range	35-90% (1DGX4, 1DGX5, 1DGX6)
Bucket Capacity	12.6 pints (1DGX4), 21 pints (1DGX5, 1DGX6)
Net Weight	25 kg
Receptacle Requirement	NEMA 5-15R
Minimum Wire size	#14 (A.W.G.) 3-Conductor, Use Copper Wire Only
Circuit Protection	15 Amp Time Delay Fuse or Circuit Breaker
(*) Capacity will vary according to actual room ambient temperature and humidity conditions.	

Dimensions

Model	H in. (mm)	W in. (mm)	D in. (mm)
1DGX4	19.8 (503)	13.3 (338)	10.0 (254)
1DGX5, 1DGX6	21.0 (533)	24.5 (622)	15.5 (394)

Unpacking

1. Remove dehumidifier from carton.
2. Remove any protective packaging applied to dehumidifier for shipment.
3. Check for loose or missing parts. Check for shipping damage. If any parts are missing or damaged, promptly contact the dealer for additional instructions.
4. A piece of tape is attached to the condensate container to ensure safe shipping. This piece of tape may be removed.

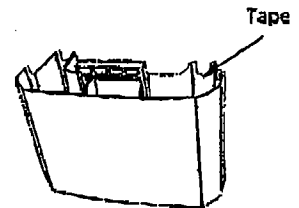

Figure 3

E
N
G
L
I
S
H

Dayton® Dehumidifiers

E
N
G
L
I
S
H

General Safety Information

▲ CAUTION Before you use your dehumidifier, please read this instruction manual carefully.

FUNCTIONS

- Helps prevent mold on clothing, etc. Open cupboards, doors and drawers before turning the dehumidifier on.
 - Helps prevent condensation on ceilings, walls, and glazing. To obtain best results, refrain from opening and closing the windows.
 - Dehumidifying is effective on moisture-sensitive items like musical instruments, cameras, computers, etc.
 - Takes away the dampness from bookshelves and closets. Open the door of the closet and put the dehumidifier close to the door for it to operate effectively.
- ### SAFETY NOTES
- Do not connect unit to any AC electrical outlet that is damaged.
 - Ensure removable covers and containers are correctly fitted before switching on unit.
 - Always switch off the unit before unplugging.
 - Do not use in the following locations:
 - Next to source of heat e.g. a radiator or heater, tumble dryer etc.
 - An area where oil or water is likely to splash.
 - An area exposed to direct sunlight.
 - Near a bath, shower or a swimming pool.
 - In a greenhouse.
 - Never insert your finger or other foreign objects into grills or openings. Take special care to warn children of these dangers.
 - Always store the unit upright in order to maintain the compressor in a proper working condition. Leave the unit upright for at least 24 hours before operating.
 - Always unplug the unit before cleaning.
 - Do not cover the unit.
 - Do not spray insecticides or any other flammable sprays on the machine.
 - Do not spray water on the dehumidifier.
 - There are no user-serviceable parts. Should the unit or power cord of this appliance become damaged, the unit must be returned to the manufacturer or service agent.
 - Empty the water tank before moving the dehumidifier.
 - Models 1DGX4, 1DGX5 and 1DGX6 are fitted with an auto defrosting operation that starts when the evaporator generates frost. This function ensures continuous running when the temperature is 55°F (13°C).

▲ WARNING ELECTRICAL SHOCK HAZARD

Plug unit only into grounded electrical outlet.

Do not use an extension cord or plug adaptor with this unit.

Do not operate unit with filter removed.

Failure to follow the above precautions could result in electrical shock, fire or personal injury.

The unit may be on a fuse or circuit breaker with other devices. However, the maximum amp draw of all devices on that fuse or circuit breaker cannot exceed the ampacity of the fuse or circuit breaker.



▲ WARNING Do not operate this dehumidifier without proper time delay circuit protection. Refer to serial plate for proper power supply requirements.

▲ WARNING Do not store or use gasoline or other flammable vapors and liquids in the vicinity of this or any other appliance. The fumes can create a fire hazard or explosion.

Models 1DGX4, 1DGX5 and 1DGX6

General Safety Information (Continued)

IMPORTANT GROUNDING REQUIREMENTS

Your dehumidifier will operate on any 115 volt, 3-pronged (grounded), 60 Hz circuit. A separate line is not required, but it is advisable not to overload the circuit with heavy duty appliances such as washing machines, etc. For your safety, this dehumidifier is equipped with a 3-pronged, grounding plug and must be plugged into a properly grounded outlet. If your outlet is not of the proper type, it is your responsibility to have the outlet and wiring changed to the correct type.

⚠ WARNING DO NOT cut off the third (grounding) prong.

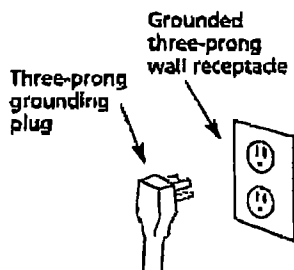

Figure 4

Features NAMES OF PARTS

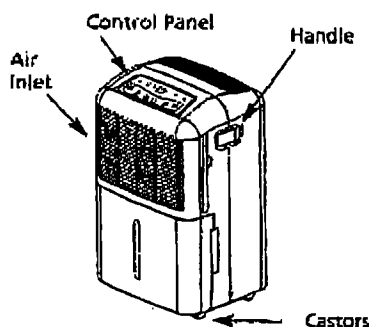

Figure 5

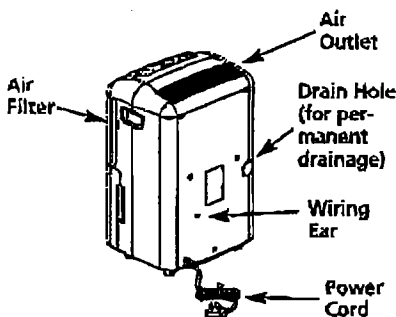

Figure 6

CONTROL PANEL

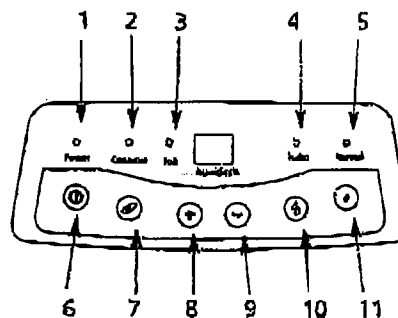

Figure 7

1. **POWER** indicator: When the unit is first connected, the indicator flashes slowly. It lights up when the unit is turned on, and goes out when the unit is turned off.
2. **Continue** indicator: Lights up when the unit is in **CONTINUOUS DEHUMIDIFYING** mode.
3. **Full** indicator: Lights up when the bucket is full, and the unit stops operating. The bucket must be emptied.
4. **Turbo** indicator: Lights up when the **(T)** button is pressed, and the fan speed is high.
5. **Normal** indicator: Lights up when the **(N)** button is pressed, and the fan speed is low.
6. **(@)** Button: The Power indicator blinks slowly when the unit is first plugged in. Press the button once and the unit will directly go into **DEHUMIDIFYING** operation with the original factory humidity setting (60% RH). Press the **(@)** button again, and the unit will stop operation.

E
N
G
L
I
S
H



Dayton® Dehumidifiers

ENGLISH

Features (Continued)

- 7. **⊕** Button: When the unit is operating, press the **⊕** button to start CONTINUOUS DEHUMIDIFYING mode.
- 8. Humidity **⊕** Button: When the unit is operating, press this button to increase the humidity setting. The range of adjustment is from 35% RH to 80% RH.
- 9. Humidity **⊖** Button: When the unit is operating, press this button to decrease the humidity setting. The range of adjustment is from 80% RH to 35% RH.
- 10. **⊕** Button: When the unit is operating, press this button to set the fan speed to high. The Turbo indicator lights up.
- 11. **⊖** Button: When the unit is operating, press this button to set the fan speed to low. The Normal indicator lights up.

Installation

To assure efficient dehumidification, close all windows and doors in the area where the dehumidifier is to operate.

Once you have assembled your dehumidifier and installed it in an appropriate location, plug the cord into a properly grounded outlet.

Install the mobile dehumidifier in a flat and spacious location where the air outlets will not be covered up. Do not install underneath desks or inside cupboards as this will restrict the air flow.

Maintain a clearance of at least 20 cm from the front and rear to maintain correct air-flow of unit.

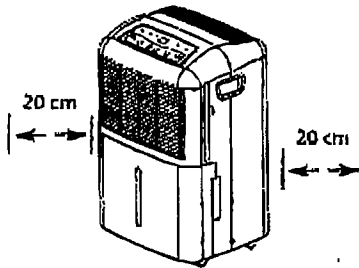

Figure 8

Operation

POWER INDICATOR

Press the "Power" button to activate the unit. The Power "On" indicator lights up. The unit is pre-set to maintain a 60% relative humidity level.

CONTAINER FULL INDICATOR

An automatic overflow switch and Container "Full" indicator light are provided to turn the dehumidifier off before the container overflows. When the indicator light on the control panel glows, the water container must be emptied. If the light remains on and the dehumidifier does not begin to operate make sure the float is attached to the water container.

⚠ WARNING This water is not suitable for drinking.

SET HUMIDITY DISPLAY

If the "Set Humidity" level is lower than the "Room" humidity level: the compressor will start up and the unit will start dehumidification. If the "Set Humidity" level is higher than the "Room" level: the unit will not dehumidify.

After operating several days at the default setting, with doors and windows closed, you may adjust the "Set Humidity" to a slightly lower percent (drier air) or higher percent (moist air). If you would like to adjust the "Set Humidity" humidity level, press the **⊕** or **⊖** buttons to adjust the humidistat in 5% increments between 35% and 90%.

Models 1DGX4, 1DGX5 and 1DGX6

E
N
G
L
I
S
H

Operation (Continued)

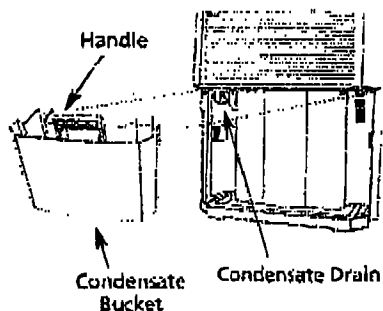

Figure 9

OPERATING INSTRUCTIONS

OPERATING CONDITIONS

- This unit is designed to operate with a working environment between 55°F (13°C) and 95°F (35°C).
- If the unit has been switched off and needs to be switched on again quickly, allow approximately three minutes for the correct operation to resume.
- Do not connect the dehumidifier to a multiple socket outlet, which is also being used for other electrical appliances.
- Select a suitable location, making sure you have easy access to an electrical outlet.
- Plug the unit into a 115 V-60 Hz electrical outlet with earth connection.
- Make sure the water tank is correctly fitted, otherwise the unit will not operate properly.

TURNING THE UNIT "ON" OR "OFF"

1. Plug the cord into an outlet with the proper power requirement. The computer system of the unit will do a

self-check. If it is normal, the Power indicator flashes at 0.5 Hz. Press the **⊕** button and the unit will start operating in DEHUMIDIFYING mode with 60% humidity setting. Press the Humidity **⊕** or **⊖** buttons to change the humidity setting.

2. Press the **⊕** button to start continuous dehumidifying mode. In this mode, the Humidity **⊕** and **⊖** buttons are disabled.
3. Press the **⊕** button to turn off the unit. (You do not need to unplug the power cord except when the unit will not be in use for a long period of time.)

WATER BUCKET

- Water will drain into the bucket. When the bucket is full and the unit stops operating, the "Full" indicator light will flash.
- Do not remove the water bucket when the machine is still working. This might cause some water to drip.
- To empty the water bucket, remove the bucket as shown. Empty the water and replace the bucket back in the unit. Ensure the components of the water bucket are correctly positioned.
- The machine will restart when the bucket is restored to its correct position.

1. Drag out the bucket a little.

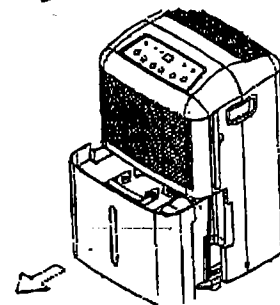

Figure 10

2. Hold the two sides of the bucket with even strength, and pull it out from the unit.

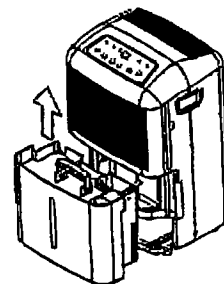

Figure 11

3. Pour the water out.

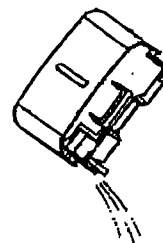

Figure 12

Dayton® Dehumidifiers

OPERATION

Operation (Continued)

CONTINUOUS DRAINAGE

- On the rear of the unit, remove the plastic cover carefully (see picture below).
- Remove the water tank first, then push the hose onto the connector located inside of the hole.
- The hose should go down smoothly without bands or kinks.
- Place the end of the hose into a suitable drainage facility.

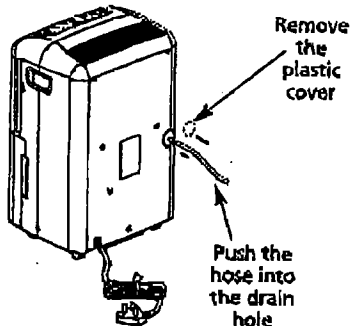

Figure 13

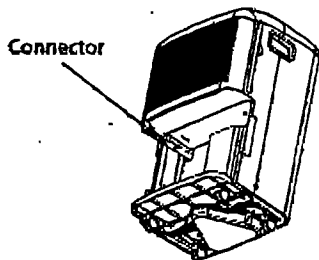

Figure 14
PERMANENT DRAIN INSTALLATION (OPTIONAL):

The condensate water can be removed directly from the unit to a drain through a garden hose with the included adapter.

1. Turn the power off before beginning work.
2. Use a screwdriver to remove the knock-out at the back of the unit.
3. Slide the garden hose adapter (supplied) over the condensate drain through the knock-out hole.
4. Connect the garden hose to the adapter.
5. The garden hose should lead to a floor drain or other appropriate drain source. The garden hose should have no inclines or sharp bends.

Maintenance FILTER CLEANING

1. Turn the power off.
2. Use a vacuum cleaner attachment or brush to clean the front grille.
3. Remove the filter.
4. To clean the filter, wash in warm, soapy water, rinse and shake dry. Proper use and care of your dehumidifier will help ensure longer life of the unit. It is recommended to annually inspect and clean the coils and condensate water passages. Expense of annual inspection is the consumers' responsibility.

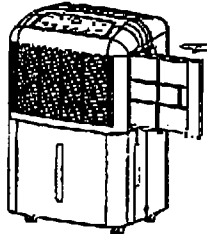

Figure 15

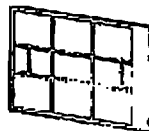

Figure 16

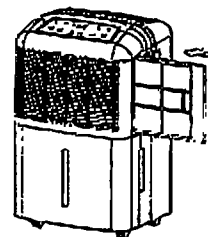

Figure 17

⚠ WARNING Never operate the unit without a filter.

IMPORTANT: Be sure to unplug the unit before cleaning.

- Do not use gasoline, thinners or other chemical agents to clean the unit as this may damage the unit.
- Do not wash the unit directly under a tap or hose. The electrical components inside may be damaged and the unit may become unsafe as a result.

AIR FILTER

Clean the air filter at least once every two weeks to prevent impaired performance of the unit.

REMOVAL

Pull the air filter out as shown (Figure 15).

CLEANING

Wash the air filter with clean water, and then carefully dry.

REPLACEMENT

Install the cleaned filter following Figure 17.

UNIT ENCLOSURE

Use a soft, clean cloth to wipe the surface. Do not use water as this may cause an electrical fault or shock hazard.

Dayton Operating Instructions and Parts Manual

Models 1DGX4, 1DGX5 and 1DGX6

Maintenance (Continued)

WATER TANK

Wash the tank using warm water (about 104°F [40°C]) with neutral detergent. Rinse and allow to dry. Replace tank when dry.

WIRING EAR

Wind the excess cord onto the wiring ear.

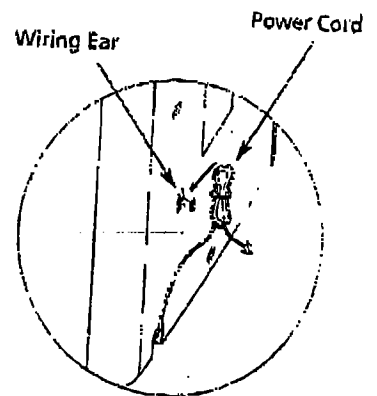

Figure 18

E
N
G
L
I
S
H

For Repair Parts, call 1-800-323-0620

24 hours a day - 365 days a year

Please provide following information:

- Model number
- Serial number (if any)
- Part description and number as shown in parts list

Address parts correspondence to:

Granger Parts
 P.O. Box 3074
 1657 Sherman Road
 Northbrook, IL 60065-3074 U.S.A.

ENGLISH

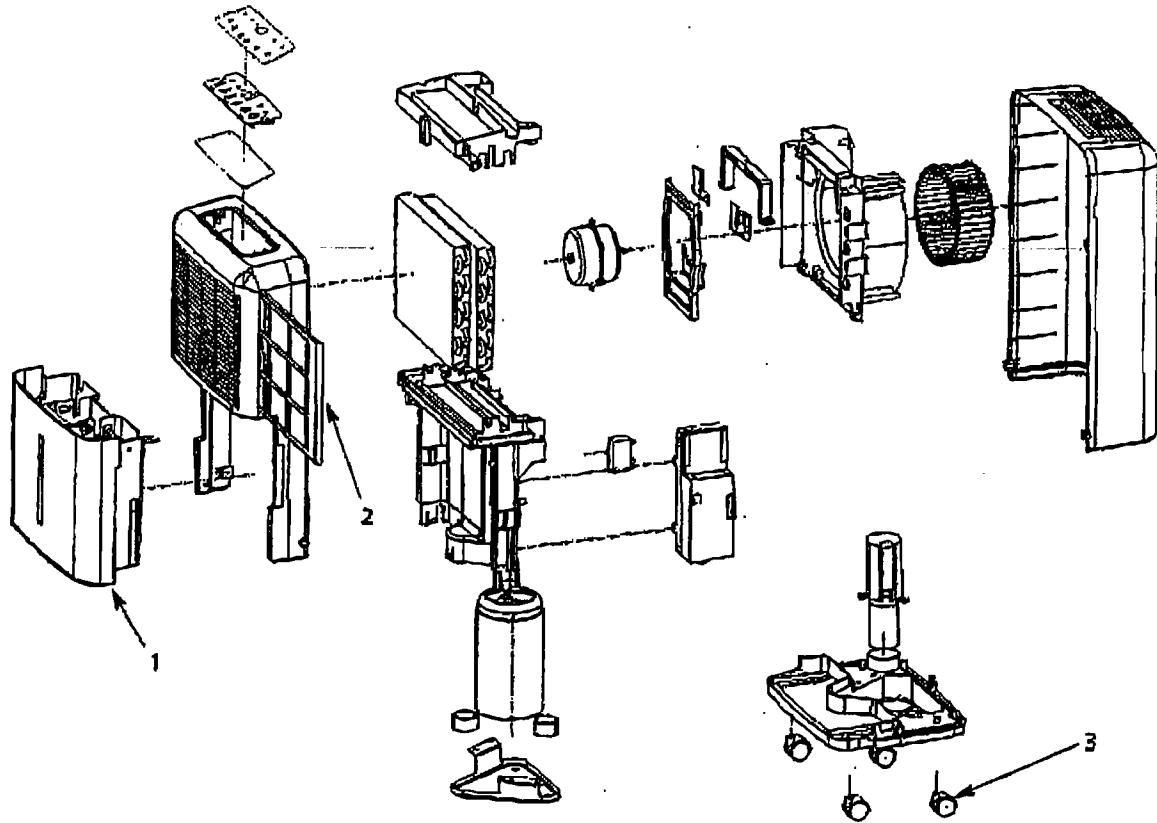

Figure 19 - Repair Parts Illustration for Model 1DGX4

Repair Parts List for 1DGX4

Ref. No.	Description	Part No.	Qty.
1	Water Tank Assembly	HV2112619069G	1
2	Filter	HV2112619066G	1
3	Caster	HV2272619012G	4

For Repair Parts, call 1-800-323-0620

24 hours a day - 365 days a year

Please provide following information:

- Model number
- Serial number (if any)
- Part description and number as shown in parts list

Address parts correspondence to:

Granger Parts
 P.O. Box 3074
 1557 Sherman Road
 Northbrook, IL 60065-3074 U.S.A.

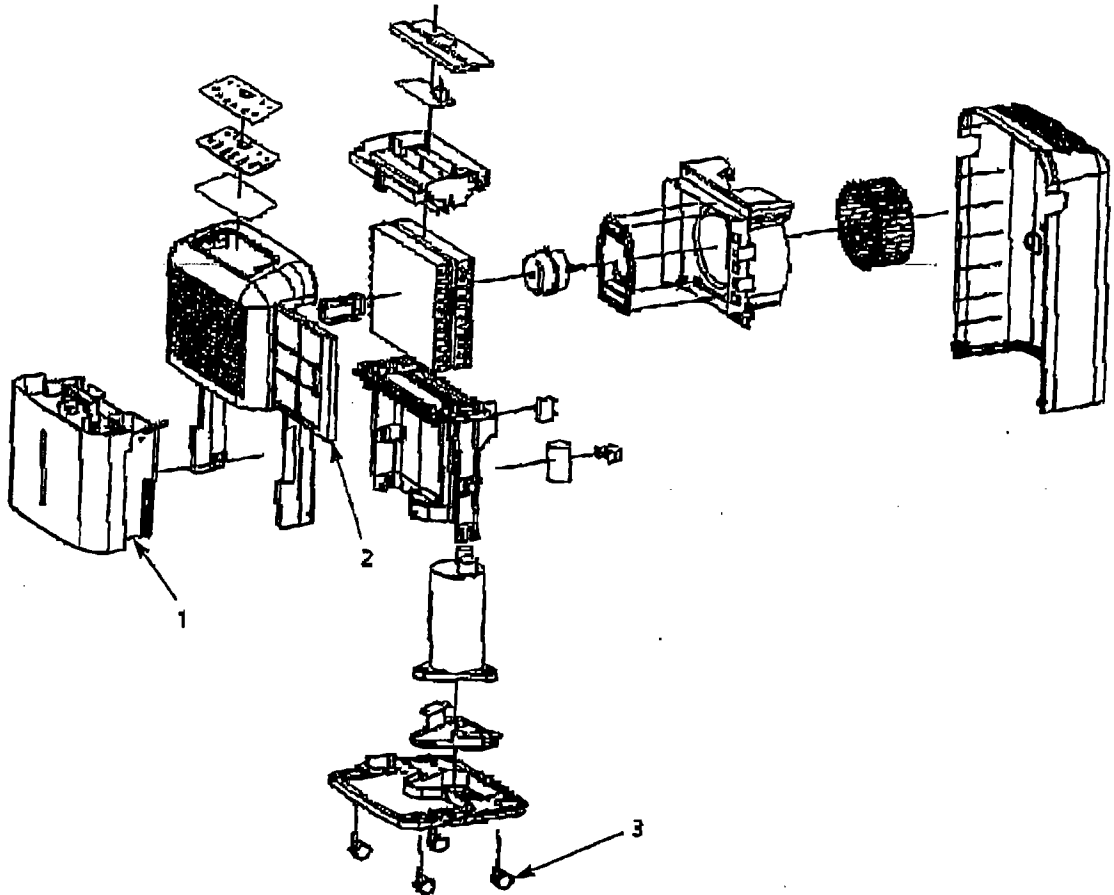

E
N
G
L
I
S
H

Figure 20 - Repair Parts Illustration for 1DGX5 and 1DGX6

Repair Parts List for 1DGX5 and 1DGX6

Ref. No.	Description	Part No.	Qty.
1	Water Tank Assembly	HV2112619051G	1
2	Filter	HV2112619047G	1
3	Caster	HV2272619012G	4

Dayton® Dehumidifiers

Troubleshooting Chart

Symptom	Possible Cause(s)	Corrective Action
Unit fails to operate	1. Power is "off"	1. Switch power "on"
	2. Power cord is unplugged	2. Plug in power cord
	3. Water bucket is not fitted correctly	3. Reposition
	4. Water bucket is "full"	4. Empty
	5. Unit is defrosting	5. After defrosting, the unit will start dehumidifying again
Performance decreased	1. Blocked air filter	1. Clean air filter
	2. Room windows and doors are open	2. Close room windows and doors
	3. Obstacles in air outlet or in air inlet	3. Remove obstacles
Unit noisy	1. Unstable position of unit	1. Reposition unit
	2. Blocked air filter	2. Clean air filter

E
N
G
L
I
S
H

LIMITED WARRANTY

DAYTON ONE-YEAR LIMITED WARRANTY. Dayton® Dehumidifiers, Models covered in this manual, are warranted by Dayton Electric Mfg. Co. (Dayton) to the original user against defects in workmanship or materials under normal use for one year after date of purchase. Any part which is determined to be defective in material or workmanship and returned to an authorized service location, as Dayton designates, shipping costs prepaid, will be, as the exclusive remedy, repaired or replaced at Dayton's option. For limited warranty claim procedures, see **PROMPT DISPOSITION** below. This limited warranty gives purchasers specific legal rights which vary from jurisdiction to jurisdiction.

LIMITATION OF LIABILITY. To the extent allowable under applicable law, Dayton's liability for consequential and incidental damages is expressly disclaimed. Dayton's liability in all events is limited to and shall not exceed the purchase price paid.

WARRANTY DISCLAIMER. Dayton has made a diligent effort to provide product information and illustrate the products in this literature accurately; however, such information and illustrations are for the sole purpose of identification, and do not express or imply a warranty that the products are **MERCHANTABLE, or FIT FOR A PARTICULAR PURPOSE, or that the products will necessarily conform to the illustrations or descriptions.** Except as provided below, no warranty or affirmation of fact, expressed or implied, other than as stated in the "LIMITED WARRANTY" above is made or authorized by Dayton.

PRODUCT SUITABILITY. Many jurisdictions have codes and regulations governing sales, construction, installation, and/or use of products for certain purposes, which may vary from those in neighboring areas. While Dayton attempts to assure that its products comply with such codes, it cannot guarantee compliance, and cannot be responsible for how the product is installed or used. Before purchase and use of a product, review the product applications, and all applicable national and local codes and regulations, and be sure that the product, installation, and use will comply with them.

Certain aspects of disclaimers are not applicable to consumer products; e.g., (a) some jurisdictions do not allow the exclusion or limitation of incidental or consequential damages, so the above limitation or exclusion may not apply to you; (b) also, some jurisdictions do not allow a limitation on how long an implied warranty lasts, consequentially the above limitation may not apply to you; and (c) by law, during the period of this Limited Warranty, any implied warranties of implied merchantability or fitness for a particular purpose applicable to consumer products purchased by consumers, may not be excluded or otherwise disclaimed.

PROMPT DISPOSITION. Dayton will make a good faith effort for prompt correction or other adjustment with respect to any product which proves to be defective within limited warranty. For any product believed to be defective within limited warranty, first write or call dealer from whom the product was purchased. Dealer will give additional directions. If unable to resolve satisfactorily, write to Dayton at address below, giving dealer's name, address, date, and number of dealer's invoice, and describing the nature of the defect. Title and risk of loss pass to buyer on delivery to common carrier. If product was damaged in transit to you, file claim with carrier.

Manufactured for Dayton Electric Mfg. Co., 5959 W. Howard St., Niles, Illinois 60714 U.S.A.

Manufactured for Dayton Electric Mfg. Co.,
Niles, Illinois 60714 U.S.A.

Dayton®