

Owner's Manual
Manual Del Propietario

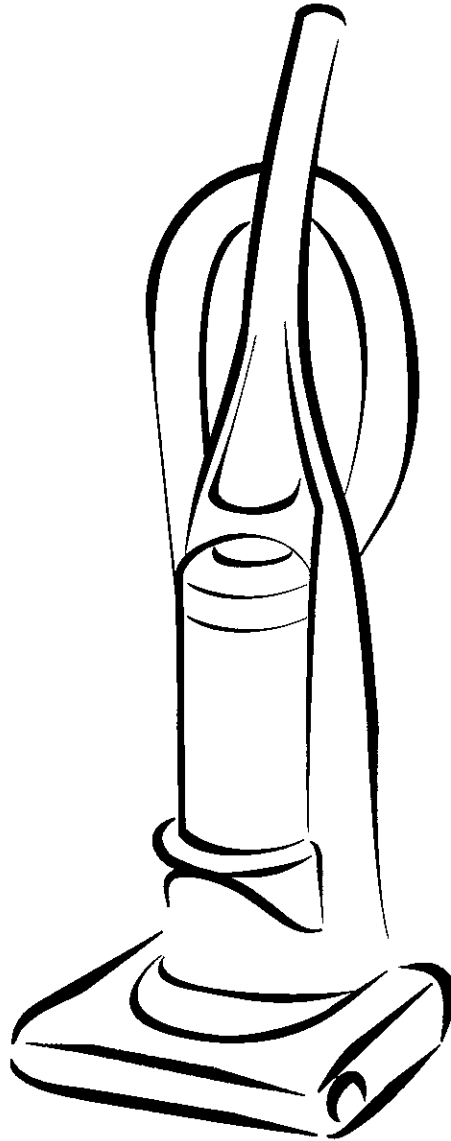

Vacuum Cleaner
Aspiradora

Model , Modelo 116.33720
116.33721



ENGLISH

ESPAÑOL

CAUTION:

Read and follow all safety and operating instructions before first use of this product.

CUIDADO:

Lea y sigue todas las instrucciones de operación y seguridad antes del uso de este producto.

Sears, Roebuck and Co., Hoffman Estates, IL 60179 U.S.A.
www.sears.com

TABLE OF CONTENTS

Before Using Your New Vacuum	2	Vacuum Cleaner Care	12
Kenmore Vacuum Cleaner Warranty	2	Vacuum Storage	12
Important Safety Instructions	3	Cleaning Exterior and Attachments	12
Parts and Features	4	Dust Bin Cleaning	13-14
Assembly Instructions	5-6	Secondary Filter Cleaning	14
Operating Instructions	7	Filter Changing/Cleaning	15
Pile Height Selection and Setting	7	Belt Changing and Agitator Cleaning	16-17
Releasing the Handle	8	Clog Removal	18
ON/OFF Switch	8	Motor Protector	18
Attachments	9-10	Agitator Servicing	19
Attachment Use Chart	10	Agitator Assembly	19
Vacuuming Tips	11	Troubleshooting	20
Performance Features	11		

BEFORE USING YOUR NEW VACUUM

Please read this guide. It will help you assemble and operate your new Kenmore vacuum in the safest and most effective way.

For more information about vacuum cleaner care and operation, call your nearest Sears store. You will need the complete model and serial numbers when requesting information. Your vacuum's model and serial numbers are located on the Model and Serial Number Plate.

Use the space below to record the model number and serial number of your new Kenmore vacuum.

Model No. _____

Serial No. _____

Date of Purchase _____

Keep this book and your sales check (receipt) in a safe place for future reference.

KENMORE VACUUM CLEANER WARRANTY

LIMITED ONE YEAR WARRANTY ON KENMORE VACUUM CLEANER

This warranty is for one year from the date of purchase, and includes only private household vacuum cleaner use. During the warranty year, when this vacuum cleaner is operated and maintained according to the owner's manual instructions, Sears will repair any defects in material or workmanship free of charge.

This warranty excludes vacuum bags, belts, light bulbs, and filters, which are expendable parts and become worn during normal use.

For warranty service, return this vacuum cleaner to the nearest Sears Service Center in the United States.

This warranty applies only while this product is in use in the United States. This warranty gives you specific legal rights, and you may also have other rights which vary from state to state.

Sears, Roebuck and Co., D/817 WA, Hoffman Estates, IL 60179

IMPORTANT SAFETY INSTRUCTIONS



WARNING

Your safety is important to us. To reduce the risk of fire, electrical shock, injury to persons or damage when using your vacuum cleaner, follow basic safety precautions including the following:

Read this manual before assembling or using your vacuum cleaner.

Use your cleaner only as described in this manual. Use only with Sears recommended attachments.

To reduce the risk of electrical shock – **Do not** use outdoors or on wet surfaces.

Disconnect electrical supply before any servicing or cleaning. Failure to do so could result in electrical shock or personal injury.

Always turn cleaner off before unplugging.

Do not unplug by pulling on cord. To unplug, grasp the plug, not the cord.

Do not use with damaged cord or plug. If cleaner is not working as it should, has been dropped, damaged, left outdoors, or dropped into water, return it to a Sears Service Center.

Do not pull or carry by cord, use cord as a handle, close door on cord, or pull cord around sharp edges or corners. Do not run cleaner over cord. Keep cord away from heated surfaces.

Do not leave cleaner when plugged in. Unplug from outlet when not in use and before servicing.

Do not allow to be used as a toy. Close attention is necessary when used by or near children.

Do not handle plug or cleaner with wet hands.

Do not put any objects into openings.

Do not use with any opening blocked; keep free of dust, lint, hair and anything that may reduce air flow.

Keep hair, loose clothing, fingers, and all parts of body away from openings and moving parts.

Do not use cleaner without dust bin and/or filters in place.

Always clean the dust bin after vacuuming carpet cleaners or freshener, powders and fine dust. These products clog the filters, reduce airflow and can cause damage to the cleaner. Failure to clean the dust bin could cause permanent damage to the cleaner.

Do not use the cleaner to pick up sharp hard objects, small toys, pins, paper clips, etc. They may damage the cleaner or dust bin.

Do not pick up anything that is burning or smoking, such as cigarettes, matches, or hot ashes.

Do not use cleaner to pick up flammable or combustible liquids (gasoline, cleaning fluids, perfumes, etc.), or use in areas where they may be present. The fumes from these substances can create a fire hazard or explosion.

Use extra care when cleaning on stairs. Do not put on chairs, tables, etc. Keep on floor.

You are responsible for making sure that your vacuum cleaner is not used by anyone unable to operate it properly.

ENGLISH

SAVE THESE INSTRUCTIONS

Proper assembly and safe use of your vacuum cleaner are your responsibilities. Your cleaner is intended only for household use. Read this Owner's Manual carefully for important use and safety information. This guide contains safety statements under warning and caution symbols. Please pay special attention to these boxes and follow any instructions given. **WARNING** statements alert you to such dangers as fire, electrical shock, burns and personal injury. **CAUTION** statements alert you to such dangers as personal injury and/or property damage.

PARTS AND FEATURES

It is important to know your vacuum cleaner's parts and features to assure its proper and safe use. Review these before using your cleaner.

Item	Part No. In U.S.	Part No. In Canada
Belt	20-5275	20-40096

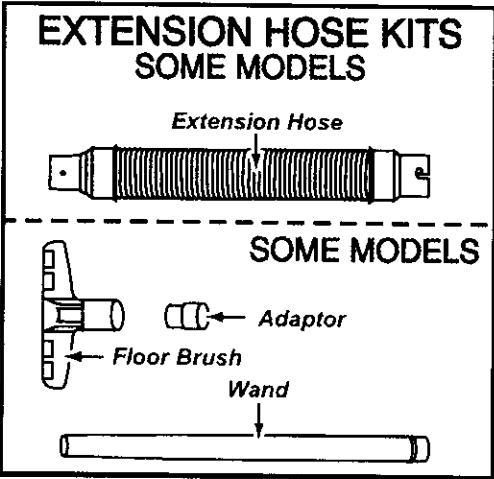
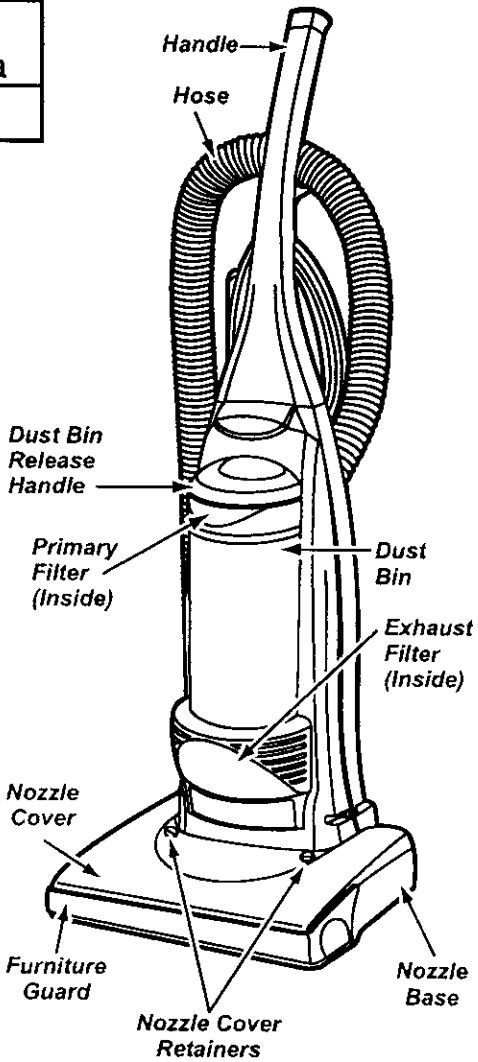
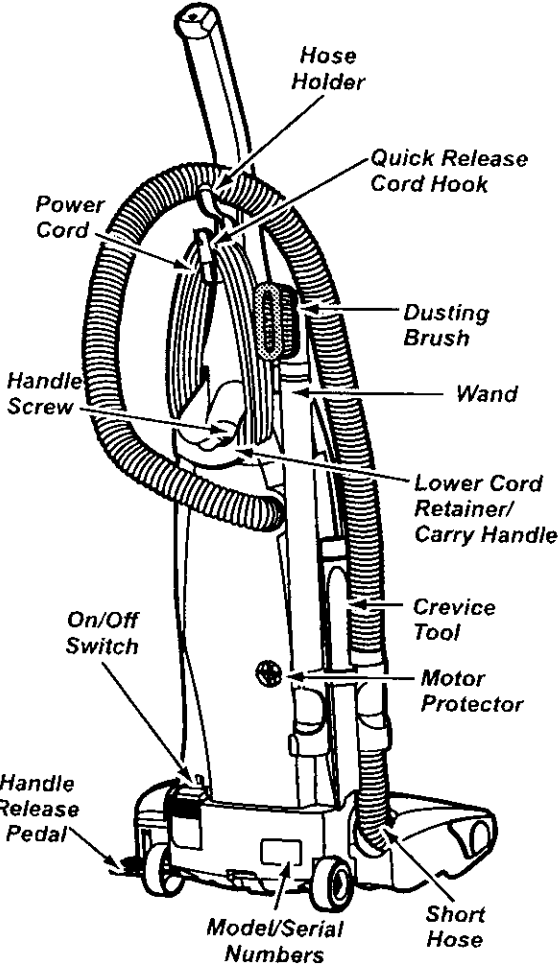

ASSEMBLY INSTRUCTIONS

Before assembling vacuum, check the PACKING LIST on the cover of the separate Repair Parts List. Use this list to verify that you have received all the components of your new Kenmore vacuum.

WARNING

Electrical Shock Hazard

Do not plug into the electrical supply until the assembly is complete. Failure to do so could result in electrical shock or injury.

HANDLE ASSEMBLY

Remove the screw located just below the top edge of the back of the vacuum.

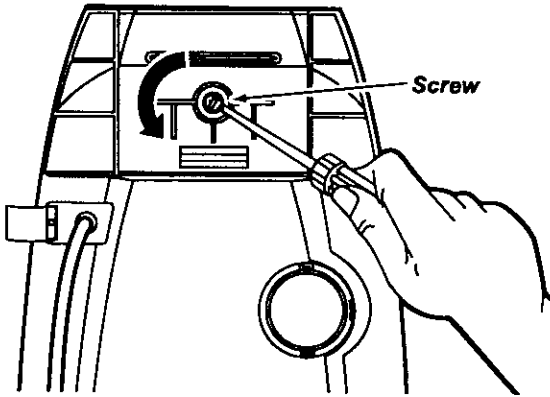

Position the handle as shown in the illustration below.

While holding the power cord out of the way, slide the handle into the opening at the top of the vacuum.

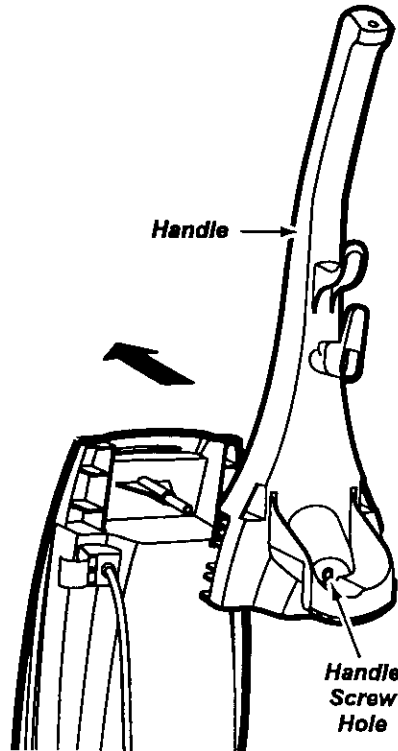

ENGLISH

Insert the screw so it passes through the handle into the vacuum.

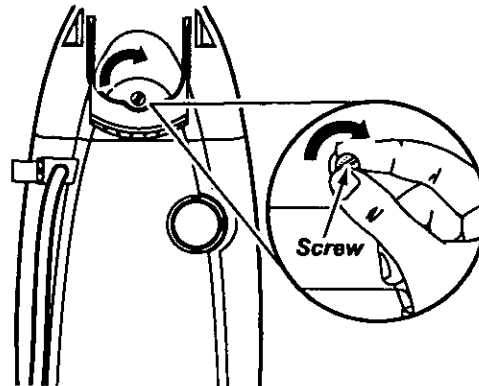

Begin to tighten the screw with your fingers. It may be necessary to adjust the handle slightly.



CAUTION

Do not overtighten.

Overtightening could strip the screw holes.

Do not operate the cleaner without the screw in place.

Using a screwdriver, tighten the screw.

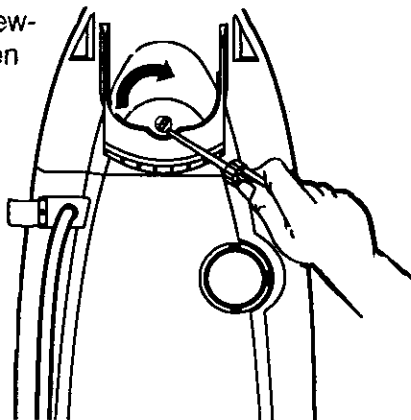

CORD ASSEMBLY

Make sure the quick release cord hook is in the upright position. Remove the wire tie from the power cord.

Lock the cord into place by forcing it into the locking notch on the body of the quick release cord hook as shown. This helps keep the power cord out from under the vacuum cleaner agitator.

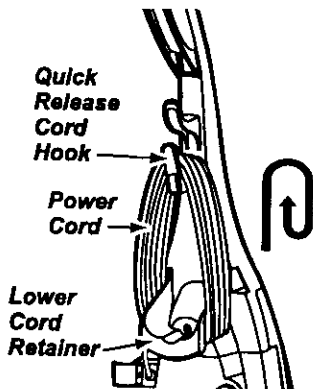
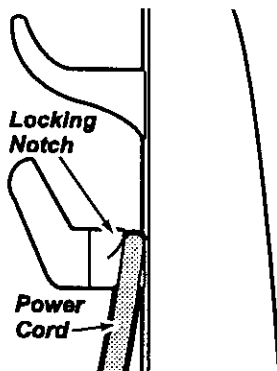

Wrap the power cord around the quick release cord hook and lower cord retainer, then lock the power cord plug onto the power cord.

ATTACHMENT STORAGE

After the handle has been assembled to the body and the power cord has been wrapped around the cord hooks, the attachments can be placed in their holders.

1. Snap the suction inlet end of the hose into the back of the vacuum cleaner.
2. Place the hose behind the handle and over the hose holder.
3. Place the hose in the front slot of the tool holder, twisting and pushing down over the short hose to assure a good connection.
4. Place the extension wand in the rear slot of the tool holder.
5. Slide the crevice tool into the slot beside the wand.
6. Place the dusting brush or combination brush on the wand with the brush portion up.

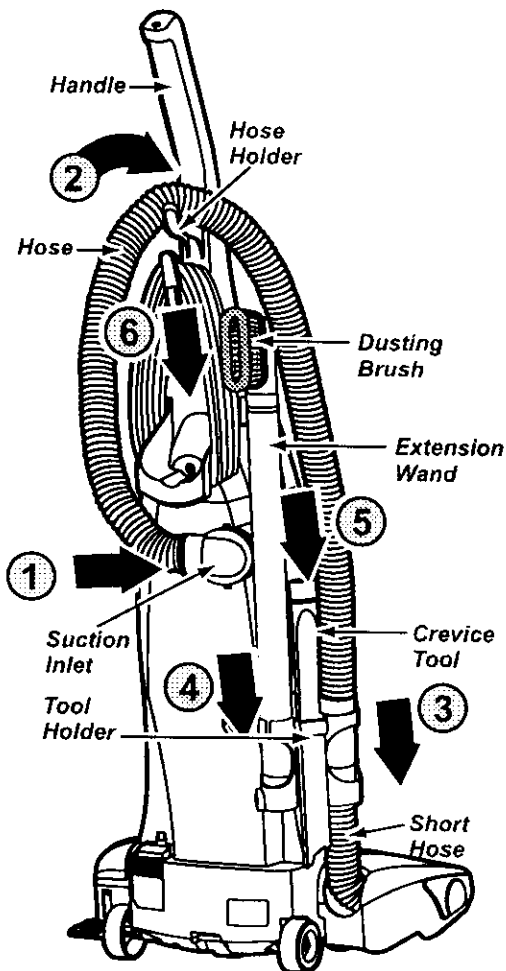

OPERATING INSTRUCTIONS

HOW TO START

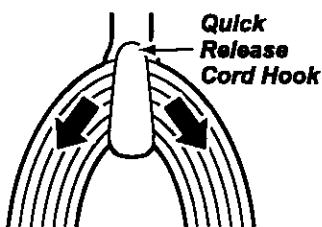

1. Turn the quick release cord hook to either side and down to release the power cord.

2. Release the power cord plug from the power cord and pull the cord off the quick release cord hook. Check to be sure the power cord is still locked into the locking notch in the quick release cord hook.

NOTE: To reduce the risk of electric shock, this vacuum cleaner has a polarized plug; one blade is wider than the other. This plug will fit in a polarized outlet only one way. If the plug does not fit fully in the outlet, reverse the plug. If it still does not fit, contact a qualified technician to install the proper outlet. Do not change the plug in any way.



WARNING

Personal Injury and Product Damage Hazard

- **DO NOT** plug in if switch is in the **ON** position. Personal injury or damage could result.
- **DO NOT** use outlets above counters. Damage from cord to items in surrounding area could occur.

3. Plug the polarized power cord into a 120 Volt outlet located near the floor.

ENGLISH

PILE HEIGHT SELECTION AND SETTING

Models with no selector adjust automatically for varying carpet heights.

SOME MODELS

To select a pile height setting:

Turn off cleaner. Select a pile height setting by tilting the cleaner back until front wheels are lifted slightly off the floor as illustrated.

Slide the adjustment lever to the correct setting.

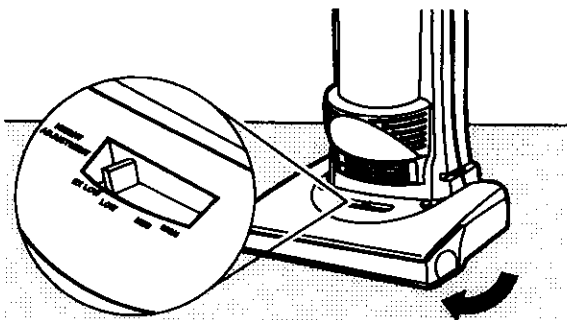

SUGGESTED PILE HEIGHT SETTINGS

You may need to raise the height to make some jobs easier, such as scatter rugs and longer pile carpets. Suggested settings are:

Models with two (2) positions:

HIGH: medium to long pile.

LOW: short to medium pile.

Models with four (4) positions:

HIGH: shag carpet, long pile, plush, scatter rugs

MED: medium to long pile.

LOW: short to medium pile.

EX LOW: very low pile.

Place unit in "HIGH" when using attachments to prevent possible floor damage.

ATTENTION: Special care is required when vacuuming certain types of carpet or floor covering. Always check the carpet or floor covering manufacturer's recommended cleaning instructions before vacuuming.

RELEASING THE HANDLE

Release the handle by placing your foot on the foot rest and pull back on the handle until it releases from its upright position.

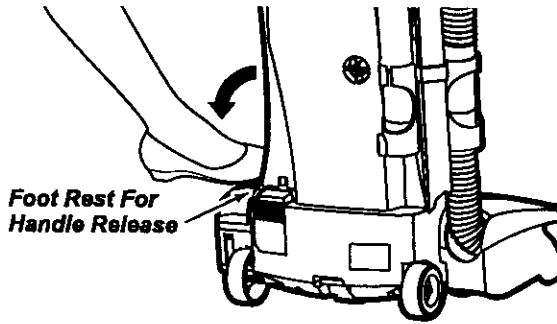

SOME MODELS

Release the handle by pressing down on the handle release pedal with your foot and pulling back and down on the handle with your hand.

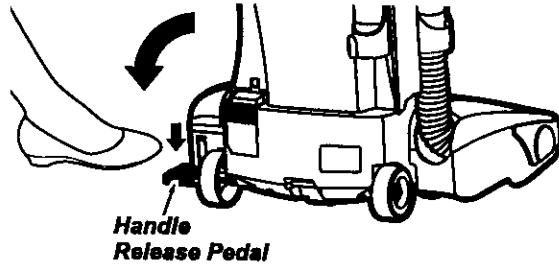

ON/OFF SWITCH

To start the vacuum cleaner, step on the ON/OFF switch located on the back of the vacuum. To stop the vacuum cleaner, step on the switch a second time.

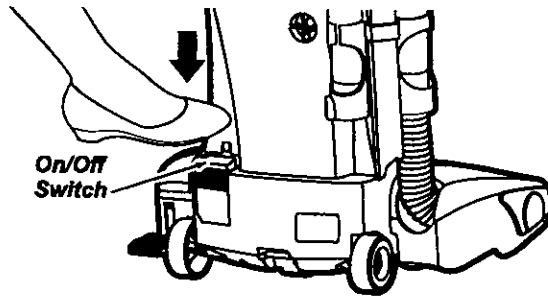

ATTACHMENTS

WARNING

Personal Injury Hazard and Property Hazard

DO NOT place hands or feet underneath the unit at any time. When using attachments, the agitator continues rotating. Do not allow the cleaner to remain in just one place for a period of time as the agitator may damage the floor surface. Avoid placing the cleaner on furniture, the fringed area of rugs, deep pile carpeting, or carpeted stairs. The ideal position for the cleaner when using attachments is for the unit to be on a level area with the handle in the full upright position.

TO USE ATTACHMENTS

CAUTION

DO NOT tip vacuum cleaner forwards or sideways when using attachments.

The attachments will fit on the hose or the wand. In addition, the dusting brush or combination brush will also fit on the crevice tool.

The hose and wand can be pulled off the short hose by grasping the cuff and twisting while pulling up.

CAUTION

DO NOT pull the vacuum cleaner around the room by the hose. Property damage could result.

The attachments can be added to the hose if the item to be cleaned is not far from the cleaner. The hose on some models will expand.

NOTE: When cleaner is turned on, the hose on some models will have a tendency to collapse due to suction of the cleaner.

If more reach is needed, the wand can be attached to the hose and the attachments can be added to the wand.

CAUTION

When using attachments, be careful not to overextend the hose length when reaching. Trying to reach beyond the hose reach could cause the cleaner to tip over.

SOME MODELS

An extra wand, without tabs, is included. This extra wand can be added to the wand with tabs for extra reach. Insert wand and twist a quarter of a turn to secure fit.

ENGLISH

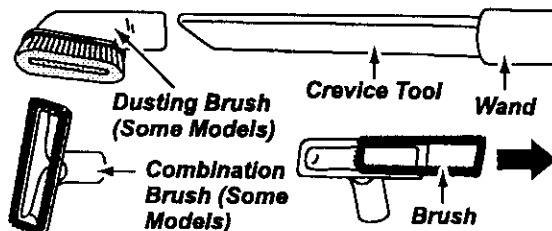

If the dusting brush/combination brush is being used and more distance is needed, the crevice tool can be added to the wand, then the dusting brush/combination brush can be added to the crevice tool.

TO STORE ATTACHMENTS

Return the hose to its position on the short hose and the attachments to their holders.

CAUTION

Attachments used in dirty areas, such as under a refrigerator, should not be used on other surfaces until they are washed. They could leave marks.



CAUTION

When using the regular hose or with the extension hose attached, the cleaner should be on a solid surface on the same level or below the level of the user's feet. **DO NOT** use the hoses when the cleaner is above the level of the user's feet.

EXTENSION HOSE

SOME MODELS

Some models include an extra hose which connects to the stretch hose on the vacuum for a longer cleaning reach.

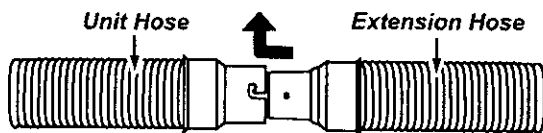

Insert the two tabs on the end of the extension hose into the two "J" shaped slots on the unit hose and twist to connect.

All attachments and the wand can be attached to the open end of the hose.



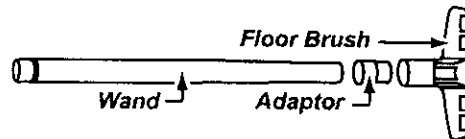

FLOOR BRUSH AND WAND

SOME MODELS

Some models have an extra brush and wand for cleaning bare floors. Twist one end of the adaptor into the floor brush and the other end into the straight wand. Connect the straight wand to the telescopic wand and then to the vacuum hose or extension hose.



ATTACHMENT USE CHART

ATTACHMENT	CLEANING AREA				
	Furniture*	Between Cushions*	Drapes*	Stairs	Walls
DUSTING BRUSH 	X		X	X	X
CREVICE TOOL 	X	X		X	
COMBINATION BRUSH 	X		X	X	
Handi-Mate ® Jr. 	X			X	

The motor protector may open when using attachments or when cleaning new carpet due to reduced air flow caused by the attachments themselves or by new carpet fuzz filling the bag quickly.

*Always clean attachments before using on fabrics.

VACUUMING TIPS



WARNING

Personal Injury Hazard

Use care if vacuum cleaner is placed on stairs. If it falls, personal injury or property damage could result.

Carpet edges

Guide either side or the front of the nozzle along a baseboard. The full length brushes help remove trapped dirt at carpet edges.

Stairs

Put handle in full upright position. Use the crevice tool or dusting brush. Set the On/Off switch to ON.

PERFORMANCE FEATURES

ENGLISH

MOTOR PROTECTION SYSTEM

Thermal Protector

This vacuum has a thermal protector which automatically trips to protect the vacuum from overheating. If a clog prevents the normal flow of air to the motor, the thermal protector turns the motor off automatically to allow the motor to cool in order to prevent possible damage to the vacuum.

To correct problem: If this occurs, turn the vacuum off and unplug the power cord from the outlet to allow the vacuum to cool and the thermal protector to reset. **Check for and remove clogs, if necessary. Also check and clean/replace any clogged filters. Wait approximately thirty (30) minutes and plug the vacuum in and turn back on to see if the motor protector has reset. The motor protector will not reset if the vacuum is not turned off even if the vacuum has cooled down.**

PERFORMANCE INDICATOR SOME MODELS

When the unit is running with normal air flow, the light on the performance indicator is off. The light comes on whenever the airflow becomes blocked. If that occurs, check the dust bin, clean/replace clogged filters, and check other possible clog locations shown in CLOG REMOVAL.

To correct problem: See the TROUBLE-SHOOTING chart.

NOTE: The light may also come on when using attachments, due to reduced airflow through the attachment.

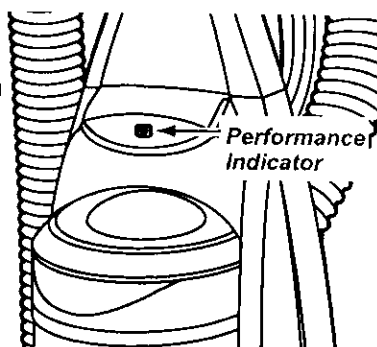

VACUUM CLEANER CARE

Always follow all safety precautions when cleaning and servicing the vacuum cleaner.



WARNING

Electrical Shock And Personal Injury Hazard

Disconnect electrical supply before servicing or cleaning the unit. Failure to do so could result in electrical shock or personal injury from cleaner suddenly starting.

VACUUM STORAGE

Gather the power cord and wrap it loosely around the quick release cord hook and lower cord retainer.

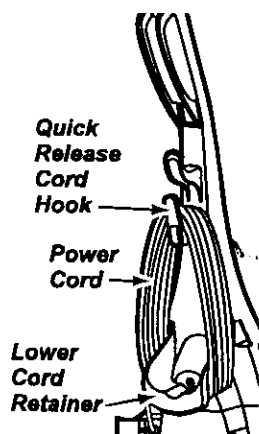

Store the cleaner in a dry, indoor area, on the floor with the handle locked in the upright position.



WARNING

Electrical Shock And Personal Injury Hazard

Wrapping the cord too tightly puts stress on the cord and can cause cord damage. A damaged cord is an electrical shock hazard and could cause personal injury or damage.

CLEANING EXTERIOR AND ATTACHMENTS

Unplug cord from wall outlet.

DO NOT drip water on cleaner.

To reduce static electricity and dust build-up, wipe outer surface of cleaner using a clean, soft cloth that has been dipped in a solution of mild liquid detergent and water, then wrung dry. Wipe dry after cleaning.

Wash attachments in warm soapy water, rinse and air dry. **Do not clean in dishwasher.**



CAUTION

Do not use attachments if they are wet. Attachments used in dirty areas, such as under a refrigerator, should not be used on other surfaces until they are washed. They could leave marks.

DUST BIN CLEANING

Always empty the dust bin when dirt level reaches the "MAX FILL" line.

TO REMOVE DUST BIN



WARNING

Always unplug power cord from electrical outlet before performing any service on vacuum.

Lift dust bin handle located at the top of the dust bin.

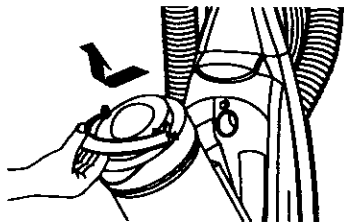
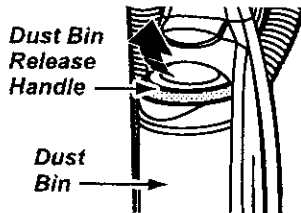

Pull the handle forward and lift dust bin up and out of the vacuum cleaner.

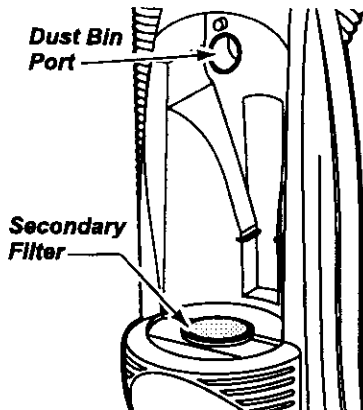

Remove any clogs that might be located in the dust bin port or the secondary filter.

TO EMPTY DUST BIN

Turn This Direction To Open For Emptying

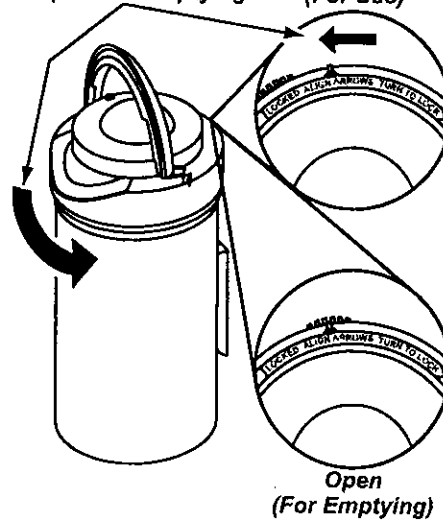

Rotate dust bin lid assembly counterclockwise as indicated on the lid and lift off.

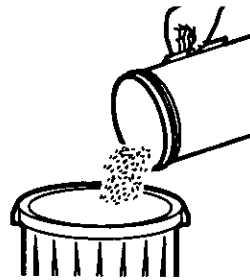

Pour dust bin contents into a trash container.

TO CLEAN FILTER

The filter may be cleaned by tapping it on a firm surface or by rinsing it under a faucet. See Filter Changing/Cleaning section **Rinse with water only**, do not use any detergent or soap. Allow the filter to dry for 24 hours before putting it back into the vacuum.

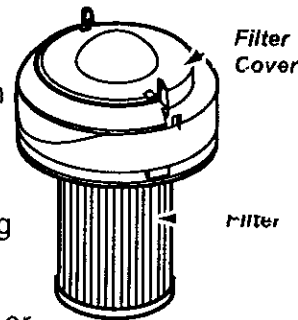

ENGLISH

TO REPLACE DUST BIN

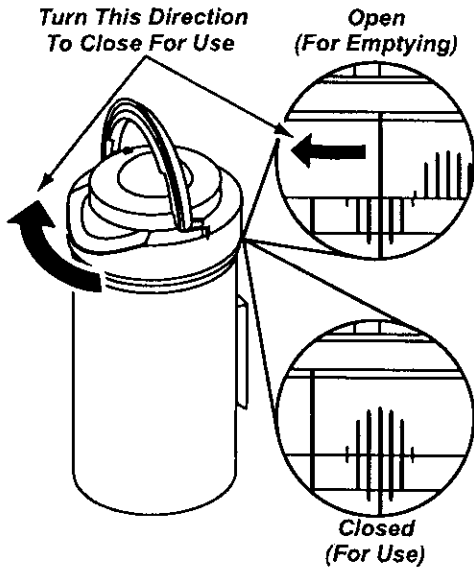

Place dust bin lid assembly back onto top of dust bin. Align lid marks with bin marks as shown above in **Open (For Emptying)**. Rotate lid clockwise while pressing downward so that marks align as shown in **Closed (For Use)**.

Place dust bin back into vacuum cleaner by inserting the bottom first and tilt back with the dust bin handle raised.

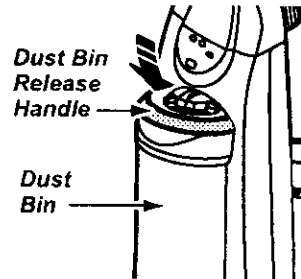
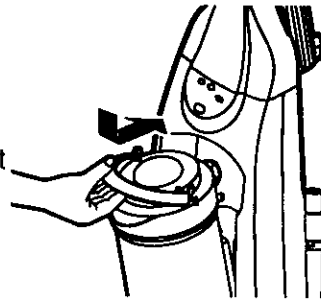

Push forward and lower the dust bin handle to lock dust bin in place.

SECONDARY FILTER CLEANING

Check secondary filter frequently and clean when dirty.



WARNING

Electrical Shock Hazard

Do not operate the cleaner without the motor safety filter. Be sure the filter is properly installed to prevent motor failure and/or electrical shock.

Always unplug power cord from electrical outlet before performing any service on vacuum.

SECONDARY FILTER FOAM

Remove the dust bin as outlined in the DUST BIN CLEANING section.

Remove secondary filter from vacuum cleaner.

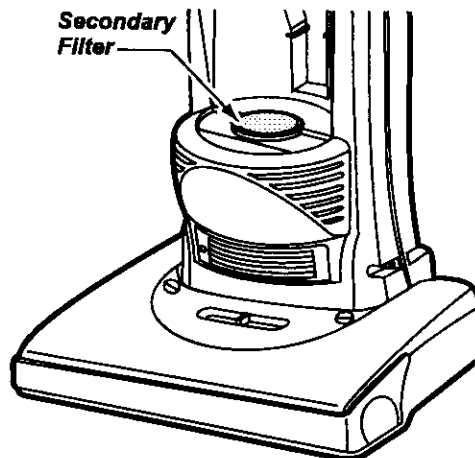

Wash the secondary filter in warm soapy water; rinse and dry thoroughly by squeezing the filter in your hand and letting it air dry.

DO NOT wash in the dishwasher.

DO NOT install damp.

Replace dry secondary filter. Ensure filter is properly installed over filter opening.

Replace the dust bin as outlined in the DUST BIN CLEANING section.

FILTER CHANGING/CLEANING



WARNING

Electrical Shock Hazard

Unplug power cord from electrical outlet. Do not operate the cleaner without the primary or exhaust filters. Be sure the filters are properly installed to prevent motor failure and/or electrical shock.

PRIMARY FILTER

Check primary filter frequently and clean when dirty.

TO REMOVE PRIMARY FILTER

Remove the dust bin and dust bin lid assembly as outlined in the DUST BIN CLEANING section. While holding the primary filter over a trash container grasp filter, rotate and lift off.

Clean primary filter by gently tapping over a trash container.

Tap on several sides to ensure best cleaning.

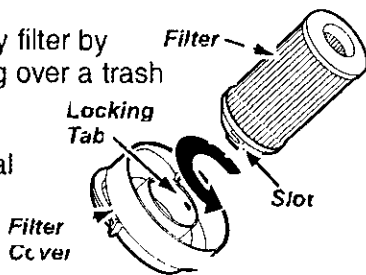

Rinse with water only as needed (see Dust Bin Cleaning).

When cleaning the filter no longer restores vacuum suction to full power you need to replace the filter.

TO REPLACE PRIMARY FILTER

Make sure that the slots of the filter line up with the locking tabs on the filter cover. Replace filter and rotate filter until slots lock onto tabs in cover.

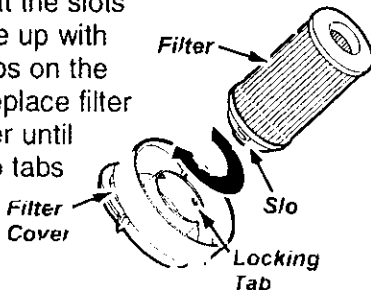

Note: Under normal use and care, your filter can be expected to last up to 3 years.

Re-attach the filter cover and filter to dust bin (see Dust Bin Cleaning). Place dust bin back into cleaner.

EXHAUST FILTER FOAM

Press inward on each side of exhaust filter cover and pull out to remove from vacuum cleaner.

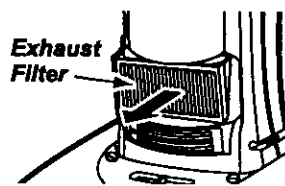
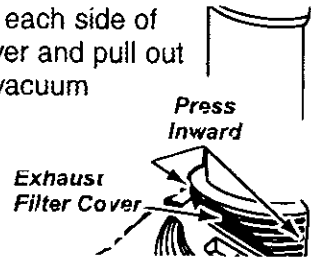

Remove the frame and filter.

Push only on filter frame, not on filter itself.

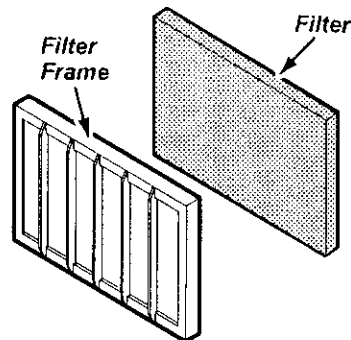

Wash the exhaust filter in warm soapy water; rinse and dry thoroughly by squeezing the filter in your hand and letting it air dry.

DO NOT wash in the dishwasher.

DO NOT install damp.

Replace the exhaust filter, carefully positioning it so that it fits into the frame.

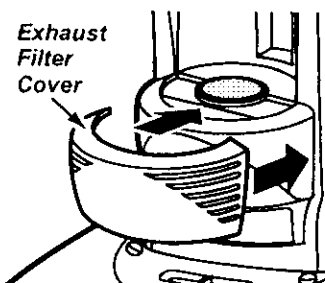

Replace the exhaust filter cover by placing tabs in slots and pushing in until cover snaps into place.

ENGLISH

BELT CHANGING AND AGITATOR CLEANING



WARNING

Electrical Shock Or Personal Injury Hazard

Disconnect electrical supply before servicing or cleaning the unit. Failure to do so could result in electrical shock or personal injury from cleaner suddenly starting.

Frequently check and remove hair, string and lint build-up in the brush area. If build-up becomes excessive, follow the steps below. Should the belt become loose or should it break, follow the Belt Removal Instructions.

TO REMOVE NOZZLE COVER

Disconnect electrical supply.

To protect the floor surface, always place paper under the nozzle any time the nozzle cover is removed.

Release the nozzle cover by rotating the nozzle cover retainers to the UNLOCK position. Grasp back of nozzle on each side and lift up to remove it from nozzle cover.

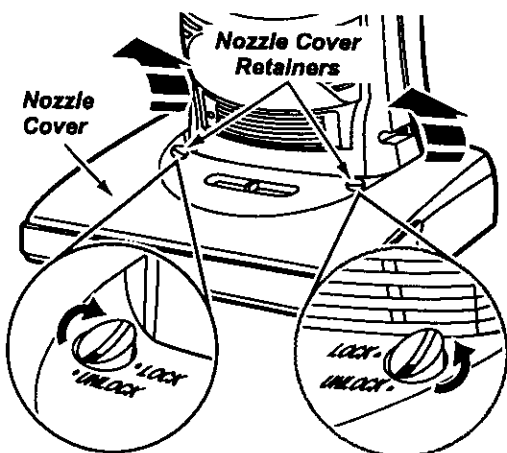

Carefully remove any residue that may exist in the belt area.



WARNING

Personal Injury Hazard

Always unplug the vacuum cleaner before cleaning the brush area as agitator may suddenly restart. Failure to do so can result in personal injury.

TO REMOVE BELT/CLEAN AGITATOR

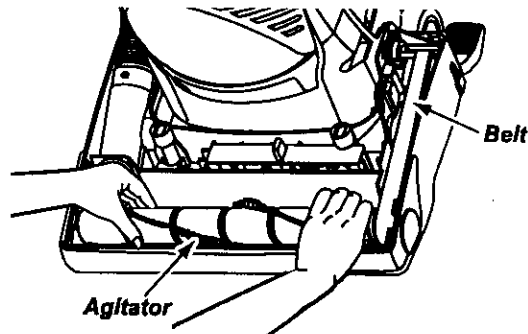

Position hands on the agitator. If the belt is still attached to the agitator, there will be tension on it.

Carefully lift the right end of the agitator and then lift the left end.

Remove the worn or broken belt from the motor drive shaft.



WARNING

Personal Injury Hazard

Be careful when removing the agitator as the belt tension is high. Failure to do so could result in personal injury from the agitator releasing quickly and snapping away.

Remove the agitator to check for string and hair build-up.

NOTE: In order to keep cleaning efficiency high and to prevent damage to your vacuum, the agitator must be cleaned every time the belt is changed.

The agitator must also be cleaned according to the following schedule:

<u>Vacuum Use</u>	<u>Clean Agitator</u>
HEAVY - (used daily)	every week
MODERATE - (used 2-3 times/week)	every month
LIGHT - (used 1time/week)	every 2 months

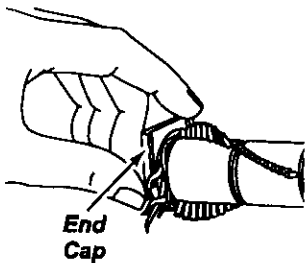

Cut off any carpet pile, hair or lint entangled around the agitator and remove any string or debris located near the end caps.

TO REPLACE BELT

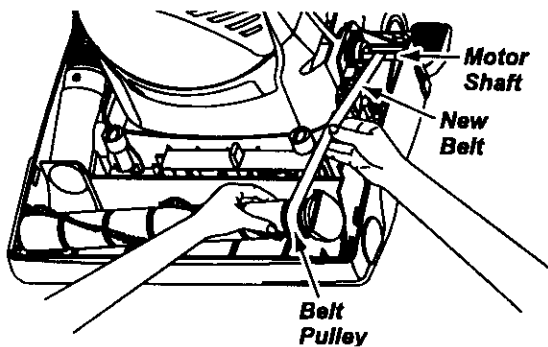

Seat left end of agitator into nozzle base. To seat agitator end, place rounded portion of agitator end cap down into slot in nozzle base.

Loop the new belt on the motor shaft.

NOTE: Use Belt #20-5275

Loop the other end of belt onto the belt pulley on the right end of agitator.

Pull right end of agitator forward and seat it into nozzle base

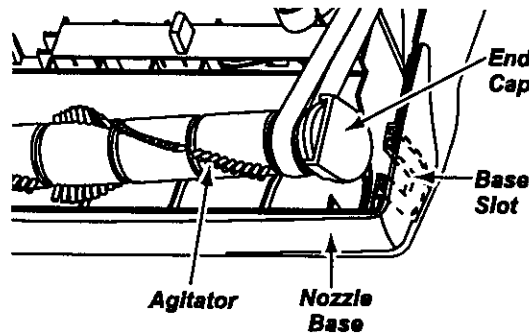

Press firmly, checking to see that each end is completely inserted.

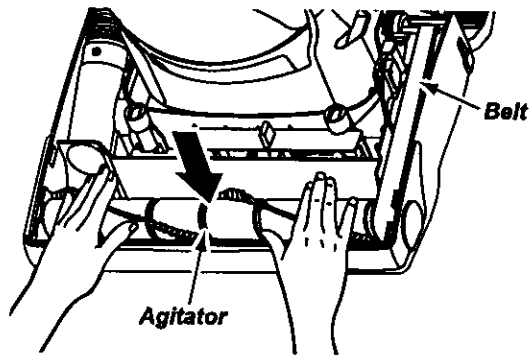

Check to see that the belt is centered on the belt pulley and that the agitator turns freely.

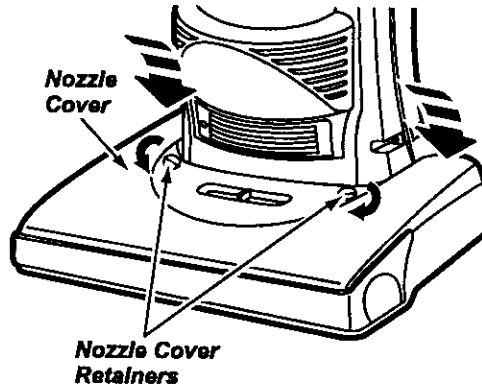

Make sure the nozzle cover retainers are in the UNLOCK position. Hook the front of the nozzle cover on to the nozzle base and rotate downward. Once in place, rotate the nozzle cover retainers to the LOCK position.

ENGLISH

CLOG REMOVAL



WARNING

Electrical Shock Or Personal Injury Hazard

Disconnect electrical supply before servicing or cleaning the unit. Failure to do so could result in electrical shock or personal injury from cleaner suddenly starting.

Always follow all safety precautions when cleaning and servicing the vacuum cleaner.

If the cleaner does not seem to have adequate suction, first check if the dust bin is full or if a filter is clogged. See DUST BIN CLEANING and FILTER CLEANING / CHANGING.

If the dust bin and filter areas are free of clogs, check the hose area. Remove the suction inlet by depressing the two tabs that secure it to the back of the vacuum and check for clogging in this area.

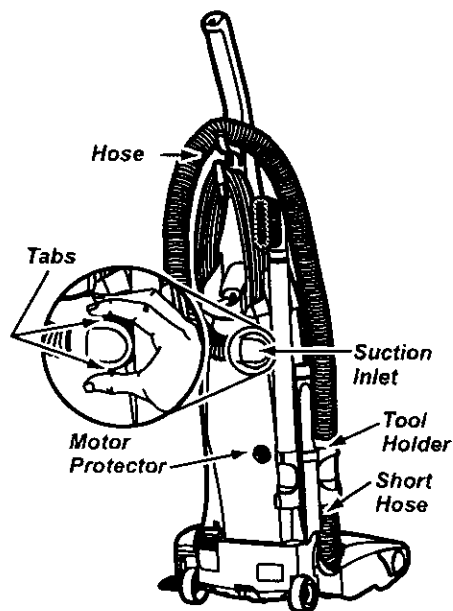

Replace the suction inlet and remove the other end of the hose from the tool holder. Plug in the vacuum and turn it on. While running the vacuum cleaner, stretch the hose in and out to remove the clog. Turn the unit off and unplug the unit.

If the clog still exists, pull the short hose out of the tool holder and inspect the short hose.

Remove any visible clogs.

MOTOR PROTECTOR

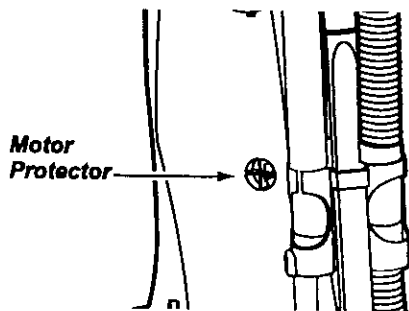

NOTE: Do not block motor protector.

This vacuum has a motor protector by-pass valve which automatically opens to provide cooling air to the motor when a clog prevents the normal flow of air. If the by-pass valve opens to prevent motor overheating and possible damage to the vacuum, a change of sound will be noticed as air rushes through the valve opening. If this occurs, turn the vacuum off and unplug the power cord from the outlet. Then check for clogs as described under the CLOG REMOVAL section.

The motor protector by-pass valve may open when using attachments or when cleaning new carpet, due to reduced air flow caused by the attachments themselves or by new carpet fuzz filling the dust bin quickly.

AGITATOR SERVICING



WARNING

Electrical Shock Or Personal Injury Hazard

Disconnect electrical supply before servicing or cleaning the unit. Failure to do so could result in electrical shock or personal injury from cleaner suddenly starting.

TO CHECK AGITATOR

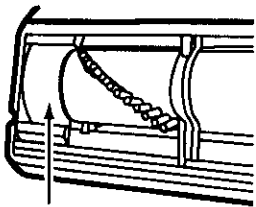

Base Belt Guard

Turn the vacuum over to check for worn brushes. When brushes are worn to the level of the base belt guard, replace the agitator.

TO REPLACE AGITATOR

Remove the nozzle cover and agitator. See BELT CHANGING AND AGITATOR CLEANING.

Replace agitator with a new one.

Reassemble the belt, agitator and nozzle cover. See BELT CHANGING AND AGITATOR CLEANING.

ENGLISH

AGITATOR ASSEMBLY

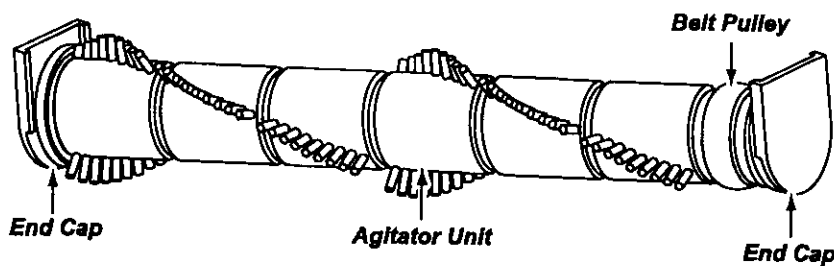

TROUBLESHOOTING

Review this chart to find do-it-yourself solutions for minor performance problems. Any service needed, other than those described in this owner's manual, should be performed at a Sears service center.



WARNING Electrical Shock Hazard

Disconnect electrical supply before servicing or cleaning the unit. Failure to do so could result in electrical shock or personal injury.

PROBLEM	POSSIBLE CAUSE	POSSIBLE SOLUTION
Cleaner won't run.	<ol style="list-style-type: none"> 1. Unplugged at wall outlet. 2. Tripped circuit breaker/blown fuse at household service panel. 3. On/off switch not turned on. 4. Thermal protector tripped. 	<ol style="list-style-type: none"> 1. Plug in firmly, push on/off switch to on. 2. Reset circuit breaker or replace fuse. 3. Push on/off switch to on. 4. Reset thermal protector, (page 11)
Poor job of dirt pick-up.	<ol style="list-style-type: none"> 1. Full or clogged dust bin. 2. Wrong pile height setting.(some models) 3. Worn agitator. 4. Clogged nozzle or dust bin port. 5. Clogged hose. 6. Hole in hose. 7. Broken/misplaced belt. 8. Hose not inserted fully. 9. Motor protection system activated. 10. Dirty filters. 	<ol style="list-style-type: none"> 1. Clean dust bin, (pages 13, 14). 2. Adjust setting, (page 7). 3. Replace agitator, (page 19). 4. Check CLOG REMOVAL, (page 18). 5. Check for clogs, (page 18). 6. Replace hose. 7. Replace/fix belt, (pages 16, 17). 8. Insert hose fully, (page). 9. Check for clogs. (page 18). 10. Clean/change filters, (page 15).
Cleaner picks up moveable rugs or pushes too hard.	<ol style="list-style-type: none"> 1. Wrong pile height setting.(some models) 	<ol style="list-style-type: none"> 1. Adjust setting, (page 7).
Agitator does not turn.	<ol style="list-style-type: none"> 1. Broken belt. 2. Belt installed incorrectly. 	<ol style="list-style-type: none"> 1. Replace belt, (pages 16, 17). 2. Check BELT CHANGING AND AGITATOR CLEANING, (pages 16, 17).
Performance indicator, some models, is red.	<ol style="list-style-type: none"> 1. Full or clogged dust bin. 2. Dirty filters. 3. Clogged airflow passage. 4. Certain attachment tools. 	<ol style="list-style-type: none"> 1. Clean dust bin, (pages 13, 14). 2. Clean/change filters, (page 15). 3. Clear clog from airflow passage, (page 18). 4. This is normal. Light should go off when tool is removed.
Air flow restricted with attachment use. Sound changes.	<ol style="list-style-type: none"> 1. Attachment use restricts air flow. 2. New carpet fuzz clogged air path. 	<ol style="list-style-type: none"> 1. Check ATTACHMENTS, (page 9). 2. Check CLOG REMOVAL and clean hose. (page 18).

Get it fixed, at your home or ours!

Your Home

For repair – **in your home** – of **all** major brand appliances, lawn and garden equipment, or heating and cooling systems, **no matter who made it, no matter who sold it!**

For the replacement parts, accessories and owner's manuals that you need to do-it-yourself.

For Sears professional installation of home appliances and items like garage door openers and water heaters.

1-800-4-MY-HOME[®] Anytime, day or night
(1-800-469-4663) (U.S.A. and Canada)
www.sears.com www.sears.ca

Our Home

For repair of carry-in products like vacuums, lawn equipment, and electronics, call or go on-line for the nearest **Sears Parts and Repair Center.**

1-800-488-1222 Anytime, day or night (U.S.A. only)
www.sears.com

To purchase a protection agreement on a product serviced by Sears:

1-800-827-6655 (U.S.A.) **1-800-361-6665** (Canada)

Para pedir servicio de reparación a domicilio, y para ordenar piezas:

1-888-SU-HOGARSM
(1-888-784-6427)

Au Canada pour service en français:

1-800-LE-FOYER^{MC}
(1-800-533-6937)
www.sears.ca

SEARS

© Sears, Roebuck and Co.

[®] Registered Trademark / TM Trademark / SM Service Mark of Sears, Roebuck and Co.

[®] Marca Registrada / TM Marca de Fábrica / SM Marca de Servicio de Sears, Roebuck and Co.

^{MC} Marque de commerce / ^{MD} Marque déposée de Sears, Roebuck and Co.