

Owner's Manual
Manual Del Propietario

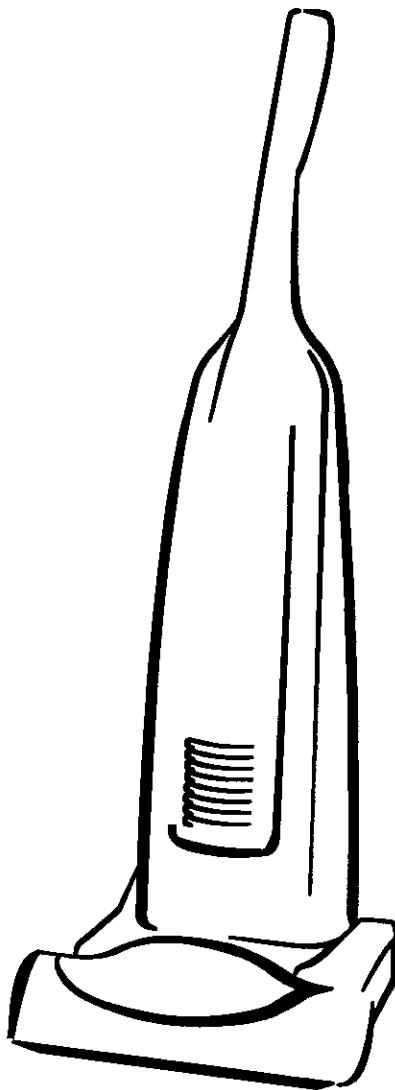

Vacuum Cleaner
Aspiradora

Model , Modelo 116.31912
 116.31913



ENGLISH

ESPAÑOL

CAUTION:

Read and follow all safety and operating instructions before first use of this product.

CUIDADO:

Lea y sigue todas las instrucciones de operación y seguridad antes del uso de este producto.

Sears, Roebuck and Co., Hoffman Estates, IL 60179 U.S.A.
www.sears.com

Part No. C01ZCHA10U00-KC01ZCHAZ0U0

Printed in Mexico
Imprimé aux Mexique

TABLE OF CONTENTS

<p>Before Using Your New Vacuum 2</p> <p>Kenmore Vacuum Cleaner Warranty 2</p> <p>Important Safety Instructions 3</p> <p>Upright Vacuum Cleaner Parts and Features 4</p> <p>Assembly Instructions 5-6</p> <p>Operating Instructions 6</p> <p style="padding-left: 20px;">Releasing the Handle 7</p> <p style="padding-left: 20px;">ON/OFF Switch 7</p> <p style="padding-left: 20px;">Pile Height Selection and Setting 7</p> <p style="padding-left: 20px;">Agitator On/Off Selector 8</p> <p style="padding-left: 20px;">Attachments 8-10</p> <p style="padding-left: 20px;">Attachment Use Chart 11</p>	<p>Vacuuming Tips 11</p> <p>Performance/Safety Features 12-13</p> <p>Vacuum Cleaner Care 14</p> <p style="padding-left: 20px;">Vacuum Storage 14</p> <p style="padding-left: 20px;">Cleaning Exterior and Attachments 14</p> <p style="padding-left: 20px;">Dust Bag Changing 15</p> <p style="padding-left: 20px;">Filter Changing 16</p> <p style="padding-left: 20px;">Light Bulb Changing 17</p> <p style="padding-left: 20px;">Agitator Cleaning 17</p> <p style="padding-left: 20px;">Clog Removal 18</p> <p>Troubleshooting 19</p> <p>Requesting Assistance Or Service 20</p>
--	---

BEFORE USING YOUR NEW VACUUM

Please read this guide. It will help you assemble and operate your new Kenmore vacuum in the safest and most effective way.

For more information about vacuum cleaner care and operation, call your nearest Sears store. You will need the complete model and serial numbers when requesting information. Your vacuum's model and serial numbers are located on the Model and Serial Number Plate.

Use the space below to record the model number and serial number of your new Kenmore vacuum.

Model No. _____

Serial No. _____

Date of Purchase _____

Keep this book and your sales check (receipt) in a safe place for future reference.

KENMORE VACUUM CLEANER WARRANTY

LIMITED ONE YEAR WARRANTY ON KENMORE VACUUM CLEANER

This warranty is for one year from the date of purchase, and includes only private household vacuum cleaner use. During the warranty year, when this vacuum cleaner is operated and maintained according to the owner's manual instructions, Sears will repair any defects in material or workmanship free of charge.

This warranty excludes vacuum bags, belts, light bulbs, and filters, which are expendable parts and become worn during normal use.

For warranty service, return this vacuum cleaner to the nearest Sears Service Center in the United States.

This warranty applies only while this product is in use in the United States. This warranty gives you specific legal rights, and you may also have other rights which vary from state to state.

Sears, Roebuck and Co., D/817 WA, Hoffman Estates, IL 60179

IMPORTANT SAFETY INSTRUCTIONS



WARNING

Your safety is important to us. To reduce the risk of fire, electrical shock, injury to persons or damage when using your vacuum cleaner, follow basic safety precautions including the following:

Read this manual before assembling or using your vacuum cleaner.

Use your cleaner only as described in this manual. Use only with Sears recommended attachments.

To reduce the risk of electrical shock – **Do not** use outdoors or on wet surfaces.

Disconnect electrical supply before any servicing or cleaning. Failure to do so could result in electrical shock or personal injury.

Always turn cleaner off before unplugging.

Do not unplug by pulling on cord. To unplug, grasp the plug, not the cord.

Do not use with damaged cord or plug. If cleaner is not working as it should, has been dropped, damaged, left outdoors, or dropped into water, return it to a Sears Service Center.

Do not pull or carry by cord, use cord as a handle, close door on cord, or pull cord around sharp edges or corners. Do not run cleaner over cord. Keep cord away from heated surfaces.

Do not leave cleaner when plugged in. Unplug from outlet when not in use and before servicing.

Do not allow to be used as a toy. Close attention is necessary when used by or near children.

Do not handle plug or cleaner with wet hands.

Do not put any objects into openings.

Do not use with any opening blocked; keep free of dust, lint, hair and anything that may reduce air flow.

Keep hair, loose clothing, fingers, and all parts of body away from openings and moving parts.

Do not use cleaner without dust bag and/or filters in place.

Always change the dust bag after vacuuming carpet cleaners or freshener, powders and fine dust. These products clog the bag, reduce airflow and can cause the bag to burst. Failure to change bag could cause permanent damage to the cleaner.

Do not use the cleaner to pick up sharp hard objects, small toys, pins, paper clips, etc. They may damage the cleaner or dust bag.

Do not pick up anything that is burning or smoking, such as cigarettes, matches, or hot ashes.

Do not use cleaner to pick up flammable or combustible liquids (gasoline, cleaning fluids, perfumes, etc.), or use in areas where they may be present. The fumes from these substances can create a fire hazard or explosion.

Use extra care when cleaning on stairs. Do not put on chairs, tables, etc. Keep on floor.

You are responsible for making sure that your vacuum cleaner is not used by anyone unable to operate it properly.

SAVE THESE INSTRUCTIONS

Proper assembly and safe use of your vacuum cleaner are your responsibilities. Your cleaner is intended only for household use. Read this Owner's Manual carefully for important use and safety information. This guide contains safety statements under warning and caution symbols. Please pay special attention to these boxes and follow any instructions given. **WARNING** statements alert you to such dangers as fire, electrical shock, burns and personal injury. **CAUTION** statements alert you to such dangers as personal injury and/or property damage.

OWNER'S MANUAL

PARTS AND FEATURES

It is important to know your vacuum cleaner's parts and features to assure its proper and safe use. Review these before using your cleaner.

Item	Part No. In U.S.	Part No. In Canada
Dust Bag	20-50690	20-50690C
Headlight Bulb	20-5248	20-5248C
Exhaust Filter	20-86889	20-86889C
Motor Safety Filter	20-86884	20-86884C

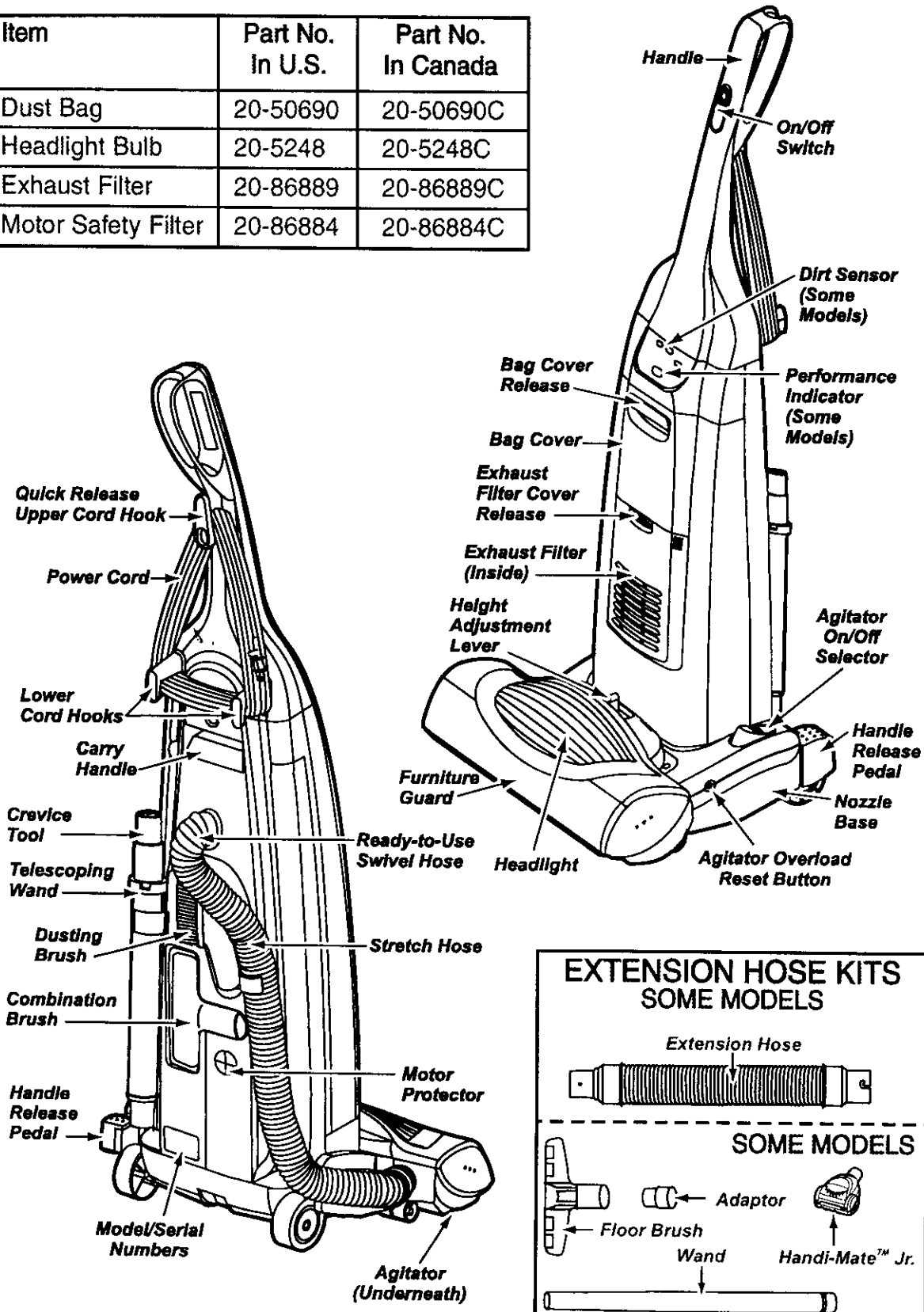

ASSEMBLY INSTRUCTIONS



WARNING

Electrical Shock Hazard

Do not plug into the electrical supply until the assembly is complete. Failure to do so could result in electrical shock or injury.

Before assembling vacuum, check the **PACKING LIST** on the cover of the separate Repair Parts List. Use this list to verify that you have received all the components of your new Kenmore vacuum.

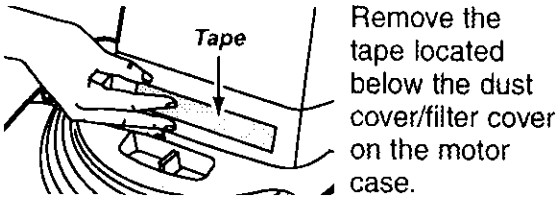

Attach stretch hose end to nozzle as shown.

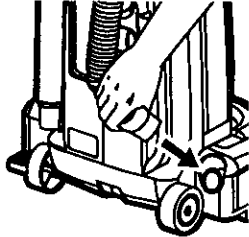

HANDLE ASSEMBLY

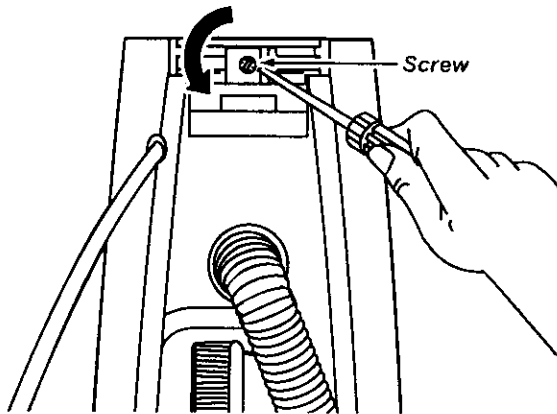

Remove the screw located just below the top edge of the back of the vacuum.

Position the handle as shown in the illustration below.

Slide the handle into the opening at the top of the vacuum.

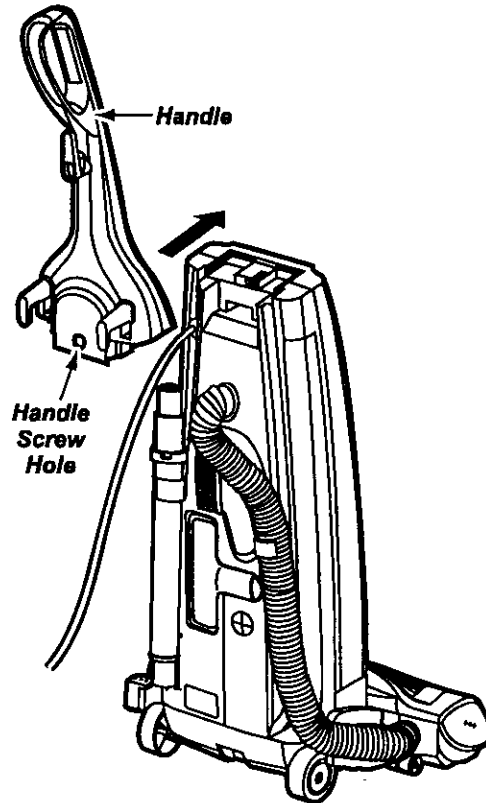

ENGLISH

Insert the screw so it passes through the handle into the vacuum.

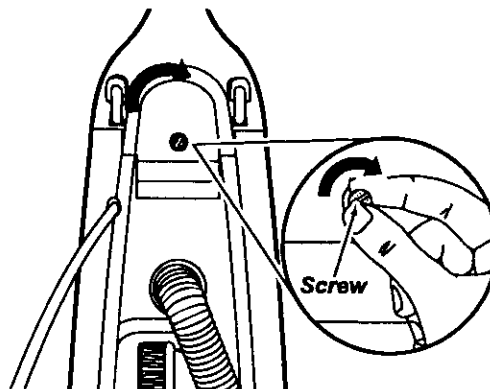

Begin to tighten the screw with your fingers. It may be necessary to adjust the handle slightly.

Using a screwdriver, tighten the screw.

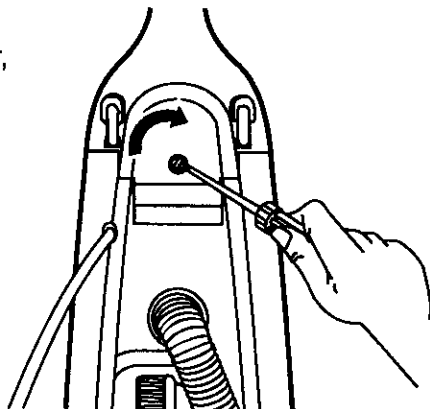

CAUTION

- Do not overtighten. Overtightening could strip the screw holes.
- Do not operate the cleaner without the screw in place.

CORD ASSEMBLY

Make sure the quick release upper cord hook is in the upright position. Remove the wire tie from the power cord.

Lock the cord into place by forcing it into the locking notch on the body of the quick release upper cord hook as shown. This helps keep the power cord out from under the vacuum cleaner agitator.

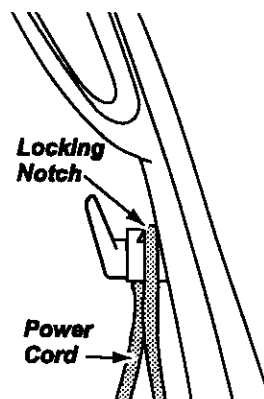

Wrap the power cord around the upper and lower cord hooks and lock the power cord plug onto the power cord.

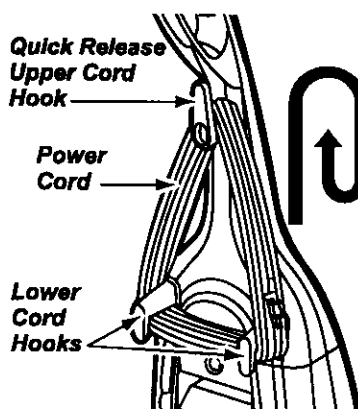

OPERATING INSTRUCTIONS

HOW TO START

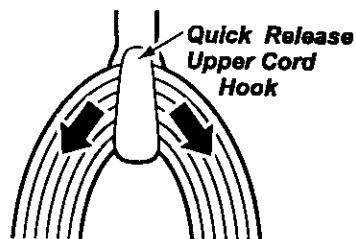

1. Turn the quick release upper cord hook to either side and down to release the power cord.

2. Release the power cord plug from the power cord and pull the cord off the quick release upper cord hook. Check to be sure the power cord is still locked into the lock in the quick release upper cord hook.

3. Check to see if the cleaner has bag installed. See DUST BAG CHANGING.

Note: To reduce the risk of electric shock, this vacuum cleaner has a polarized plug, one blade is wider than the

other. This plug will fit in a polarized outlet only one way. If the plug does not fit fully in the outlet, reverse the plug. If it still does not fit, contact a qualified technician to install the proper outlet. Do not change the plug in any way.

4. Plug the polarized power cord into a 120 Volt outlet located near the floor.



WARNING

Personal Injury and Product Damage Hazard

- DO NOT plug in if switch is in the ON position. Personal injury or damage could result.
- DO NOT use outlets above counters. Damage from cord to items in surrounding area could occur.

RELEASING THE HANDLE

Release the handle by pressing down on the handle release pedal with your foot and pulling back and down on the handle with your hand.

Note: The agitator will not rotate if the vacuum cleaner is in the upright position.

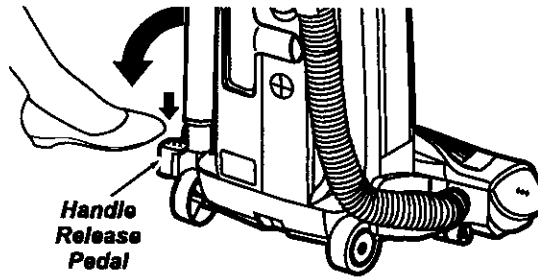

ON/OFF SWITCH

HANDLE MOUNTED

SOME MODELS

To start the vacuum cleaner, slide the On/Off switch from the OFF position to the ON position. To stop the vacuum cleaner, slide the On/Off switch to the OFF position.

Note: This switch operates the suction motor only. For the agitator to rotate, the agitator On/Off selector must be in the ON position and the handle must be released from the upright position.

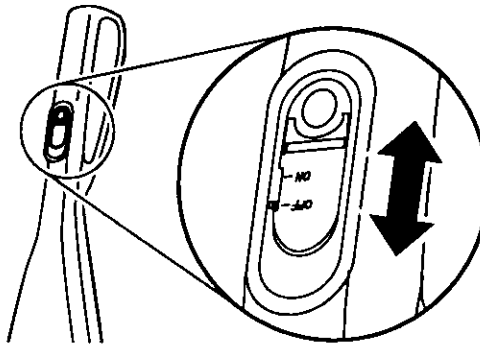

ENGLISH

PILE HEIGHT SELECTION AND SETTING

To select a pile height setting:

Turn off cleaner. Select a pile height setting by tilting the cleaner back until front wheels are lifted slightly off the floor.

Slide the adjustment lever to the correct setting.

There are four (4) pile height settings on the vacuum. Use the LOW setting for most carpets and bare floor cleaning (with agitator OFF), and the HIGH setting for very long pile carpets like shag carpet, scatter rugs, etc. Use the other settings as needed for carpet heights in-between.

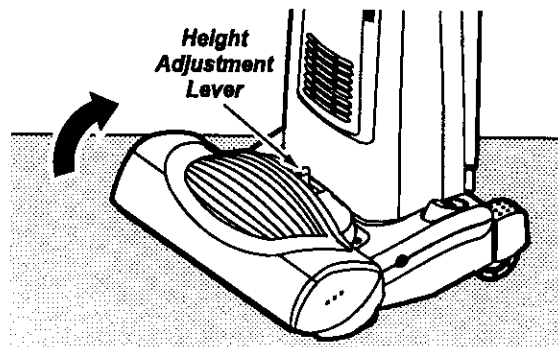

CAUTION

Do not allow vacuum cleaner to remain in one spot for any length of time when the agitator is turning. Damage to carpet may occur.

AGITATOR ON/OFF SELECTOR

OFF Position: Step on the back half of the pedal to turn off the agitator for use on **bare floors**.

In the OFF position, the agitator does not rotate. This setting should be used for cleaning hardwood and tile floors.

Note: The light will remain on when vacuuming with the agitator in the OFF Position, provided the vacuum is not fully upright.

ON Position: Step on the front half of the pedal to turn on the agitator for use on **carpeting**.

In the ON position, the agitator will turn. When carpets are being cleaned the selector should be in this position.

Attention: Refer to your carpet manufacturers cleaning recommendations. Some more delicate carpets may require that they be vacuumed with the agitator turned off, to prevent carpet damage.

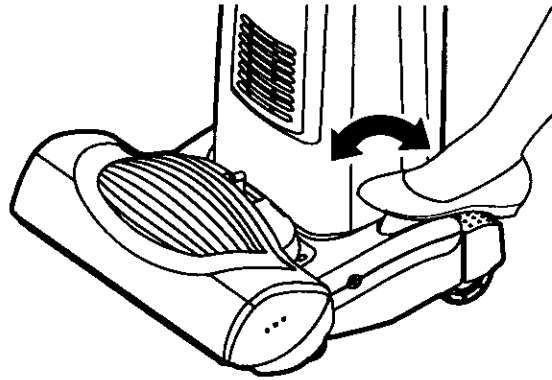

WARNING

Personal Injury Hazard

DO NOT place hands or feet underneath the unit when changing the Agitator On/Off Selector to the On position. The agitator begins to revolve rapidly.

ATTACHMENTS

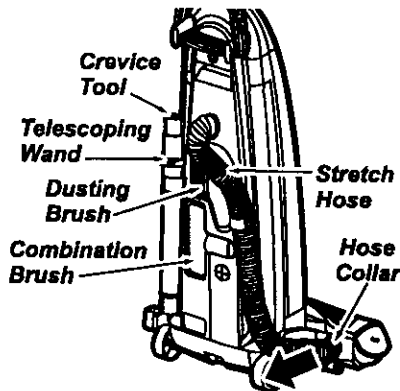

Identify each of the attachments shown above.

TO USE ATTACHMENTS:

Remove the lower end of the stretch hose from the cleaner by grasping the hose collar, twisting and pulling straight out. The attachments can now be added to the hose.

Note: The agitator will not rotate if the hose has been removed from the nozzle.



WARNING

Electrical Shock And Personal Injury Hazard

Disconnect electrical supply before servicing or cleaning the unit. Failure to do so could result in electrical shock or personal injury from cleaner suddenly starting.

The attached hose swivels to make cleaning easier in every direction. Remove the hose from the hose clip by pulling straight out.

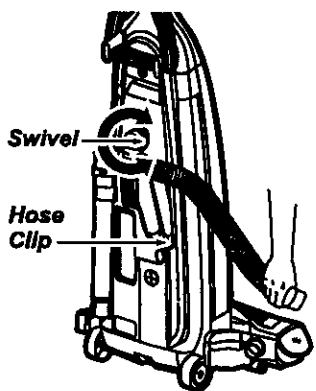

TELESCOPING WAND WITH SUCTION CONTROL SLIDE

SOME MODELS

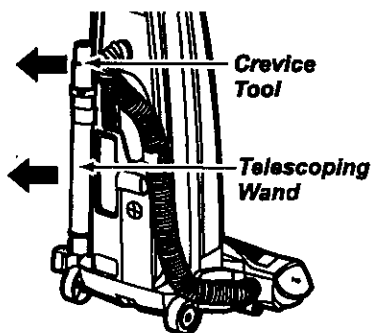

Remove the telescoping wand from its storage position.

Remove the crevice tool from its storage position in the wand. Turn the locking ring to the **UNLOCK** position.

Extend the wand to its full length. Turn the locking ring to the **LOCK** position. Attach the extension wand onto the open end of the hose.

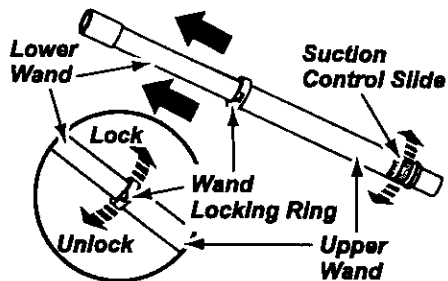

Align the tabs on the extension wand with the "J" slots in the hose. Push the wand into the hose and twist to the right to lock.

To achieve maximum reach with the attachments, add the crevice tool to the end of the wand by inserting and twisting slightly.

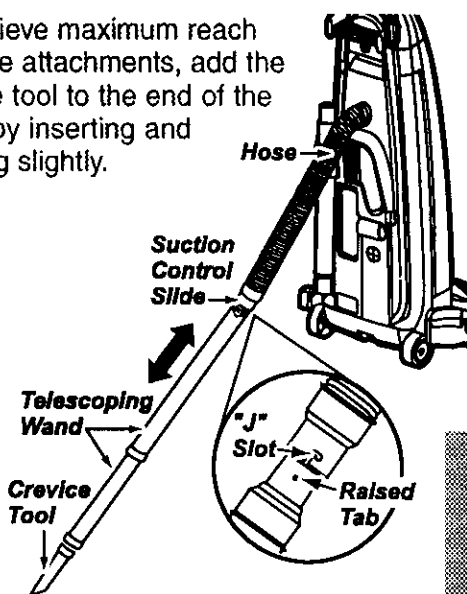

ENGLISH

When using the dusting brush or the combination brush, they may be attached directly to the wand or placed on the end of the crevice tool.

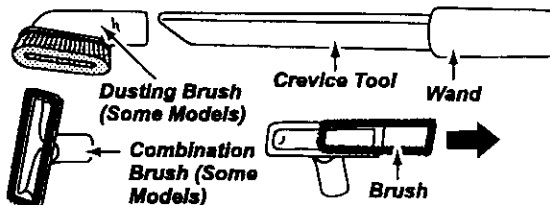

TO OPERATE SUCTION CONTROL SLIDE

Telescoping Wand

When using attachments for cleaning draperies, small rugs with low pile and other delicate items, twist the suction control slide to the open position. This lever is located on the telescoping wand, close to the hose.

This will reduce suction for ease of cleaning.

Note: Return suction control slide to the closed position for normal cleaning.



CAUTION

When using attachments, be careful not to overextend the stretch hose when reaching. Trying to reach beyond the hose stretch capability could cause the cleaner to tip over.

TO STORE ATTACHMENTS

Remove dusting brush or combination brush. Snap into appropriate storage location.

Remove crevice tool from the wand by twisting. Lay aside.

Remove the extension wand from the hose. Twist the wand to the left and pull from the hose end.

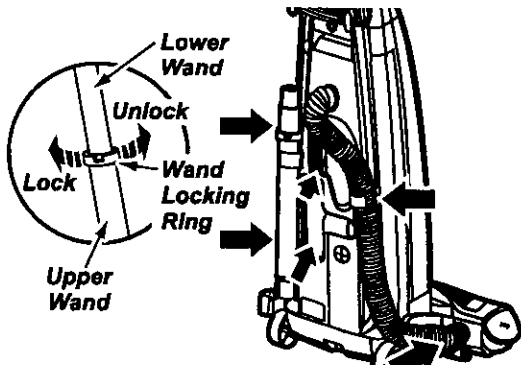

Unlock the wand by turning the wand locking ring to the **UNLOCK** position.

Slide the lower wand into the upper wand. Turn the wand locking ring to the **LOCK** position.

Place the crevice tool down into the compressed wand. Snap into the appropriate storage location.

Reinsert the hose fully into the opening on the lower body from which it was removed. Press firmly to assure connection.



WARNING

Personal Injury Hazard

The agitator may begin rotating when the hose is inserted. Ensure that the agitator is clear of all hands, feet, objects, etc.



CAUTION

DO NOT pull the vacuum cleaner around the room by the hose. Property damage could result.

EXTENSION HOSE

SOME MODELS

Some models include an extra hose which connects to the stretch hose on the vacuum for a longer cleaning reach.

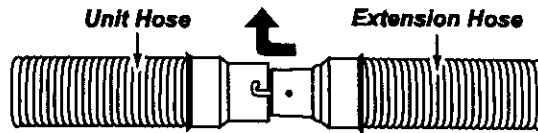

Insert the two tabs on the end of the extension hose into the two "J" shaped slots on the unit hose and twist to connect.

All attachments and the telescoping wand can be attached to the open end of the hose.

FLOOR BRUSH AND WAND:

SOME MODELS



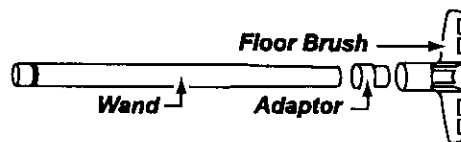

Some models have an extra brush and wand for cleaning bare floors. Twist one end of the adaptor into the floor brush and the other end into the straight wand. Connect the straight wand to the telescopic wand and then to the vacuum hose or extension hose.



CAUTION

When using the regular hose or with the extension hose attached, the cleaner should be on a solid surface on the same level or below the level of the user's feet. **DO NOT** use the hoses when the cleaner is above the level of the user's feet.

ATTACHMENT USE CHART

CLEANING AREA					
ATTACHMENT	Furniture*	Between Cushions*	Drapes*	Stairs	Walls
DUSTING BRUSH 	X		X		X
CREVICE TOOL 	X	X		X	
COMBINATION BRUSH 	X		X	X	
Handi-Mate® Jr. 	X			X	

*Always clean attachments before using on fabrics.

ENGLISH

VACUUMING TIPS

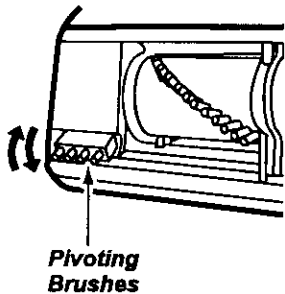

Carpet edges
Guide either side or the front of the nozzle along a baseboard. The pivoting brushes help remove dirt at carpet edges.

Stairs
Put handle in full upright position. Agitator stops rotating. Use the crevice tool or fabric brush. Set the On/Off switch to ON and move the Agitator On/Off selector to the OFF position.

For best cleaning results, keep the airflow passage clear.

Occasionally, check each of the areas indicated for clogs.

Unplug the cleaner from the outlet before checking.

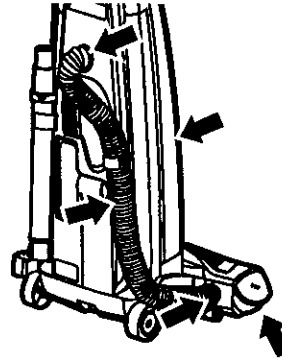

WARNING

Personal Injury Hazard

Use care if vacuum cleaner is placed on stairs. If it falls, personal injury or property damage could result.

PERFORMANCE/SAFETY FEATURES

MOTOR PROTECTION SYSTEM

Motor Protector

This vacuum has a motor protector by-pass valve which automatically opens to provide cooling air to the suction motor when a clog prevents the normal flow of air to the motor. If the by-pass valve opens to prevent motor overheating and possible damage to the vacuum, you will notice a change of sound as air rushes through the valve opening.

To correct problem: See the TROUBLE-SHOOTING chart.

NOTE: The motor protector may open when using attachments or when cleaning new carpet, due to reduced airflow by the attachments themselves or by new carpet fuzz filling the bag quickly. See the TROUBLESHOOTING section.

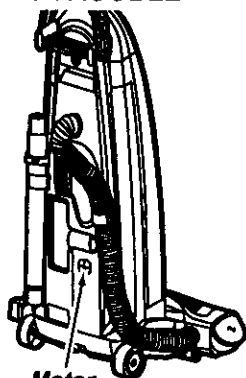

Motor Protector

Note: Do not block motor protector.

Thermal Protector

This vacuum has a thermal protector which automatically trips to protect the vacuum from overheating. If a clog prevents the normal flow of air to the motor, the thermal protector turns the motor off automatically to allow the motor to cool in order to prevent possible damage to the vacuum. During this time the headlight remains on.

To correct problem: If this occurs, turn the vacuum off and unplug the power cord from the outlet to allow the vacuum to cool and the thermal protector to reset. **Check for and remove clogs, if necessary. Also check and replace any clogged filters. Wait approximately thirty (30) minutes and plug the vacuum in and turn back on to see if the motor protector has reset. The motor protector will not reset if the vacuum is not turned off even if the vacuum has cooled down.**

AGITATOR OVERLOAD PROTECTOR

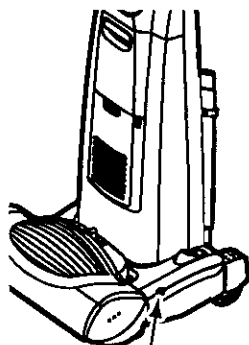

Agitator Overload Reset Button

The agitator has built-in protection against motor damage should the agitator jam. If the agitator slows down or stops, the agitator overload protector shuts off the agitator. The suction motor will continue to run.

To correct problem: Turn off and unplug vacuum, remove obstruction, then press reset button.

To reset: Push in the agitator overload protector button.

PERFORMANCE INDICATOR SOME MODELS

When the unit is running with normal air flow, the light on the performance indicator is off. The light comes on whenever the airflow becomes blocked. If that occurs, check the disposable dust bag, motor safety filter and other possible clog locations shown in CLOG REMOVAL.

To correct problem: See the TROUBLE-SHOOTING chart.

NOTE: The light may also come on when using attachments, due to reduced airflow through the attachment.

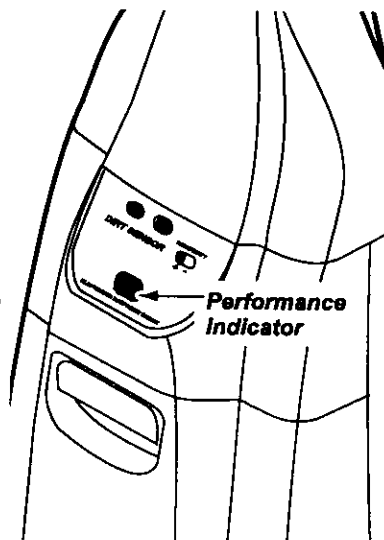

Performance Indicator

DIRT SENSOR SOME MODELS

The electronic dirt sensor is a feature which will detect particles as they pass through the vacuum cleaner.

The dirt sensor indicators and sensor sensitivity switch are located on the front of the switch cover.

A red light indicates dirt is being picked up by the cleaner. A green light indicates most of the dirt has been picked up by the cleaner.

OPERATION

As you vacuum, the red indicator light will come on and stay on as long as the sensor detects a high concentration of particles passing through the cleaner.

The green light indicates that most of the cleaning is complete.

The sensor switch allows you to select the sensitivity of the dirt sensor. The switch can be set to HI (+) or LO (-) sensitivity.

Set the sensor switch to the HI (+) position when:

- Cleaning bare floors.
- Cleaning carpet with low pile height.

Set the sensor switch to the LO (-) position when:

- Cleaning heavily soiled areas.
- Cleaning carpet with deep pile.
- Cleaning new carpets.

Even with the sensor switch in the LO (-) position, the dirt sensor will detect carpet fuzz, especially on new carpet, which may cause the red light to remain on longer than expected.

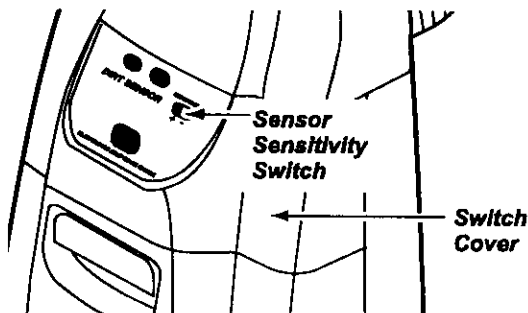

WARNING

Electrical Shock And Personal Injury Hazard

Disconnect electrical supply before servicing or cleaning the unit. Failure to do so could result in electrical shock or personal injury from cleaner suddenly starting.

TO CLEAN DIRT SENSOR OPTICS

The dirt sensor optics consist of two optic cells located inside the bag holder. Occasionally, it may become necessary to clean the two optic cells to assure maximum performance. It is recommended the optic cells be cleaned:

- When the red light stays on continuously.
- When the green light stays on continuously.
- When dirt or dust adheres to the optic cells.
- Whenever the dust bag is changed.

To clean the sensor, wipe the optic cells with a soft, dry cloth. Never use cleaners or liquids as they can help speed the recoating of the optic cells and make it necessary to clean them much sooner than normal. The dirt sensor area can be reached by removing the dust cover and the dust bag.

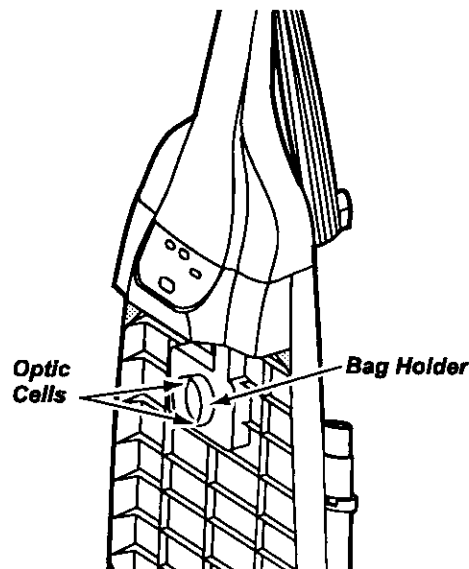

ENGLISH

VACUUM CLEANER CARE

Always follow all safety precautions when cleaning and servicing the vacuum cleaner.



WARNING

Electrical Shock And Personal Injury Hazard

Disconnect electrical supply before servicing or cleaning the unit. Failure to do so could result in electrical shock or personal injury from cleaner suddenly starting.

VACUUM STORAGE

Gather the cord and wrap it loosely around the upper and lower cord hooks.

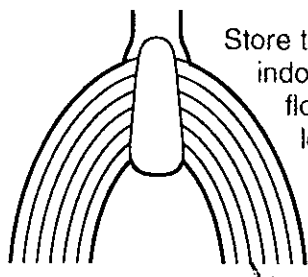

Store the cleaner in a dry, indoor area, on the floor with the handle locked in the upright position.



WARNING

Electrical Shock And Personal Injury Hazard

Wrapping the cord too tightly puts stress on the cord and can cause cord damage. A damaged cord is an electrical shock hazard and could cause personal injury or damage.

CLEANING EXTERIOR AND ATTACHMENTS

Unplug cord from wall outlet. **DO NOT** drip water on cleaner.

Clean exterior using a clean, soft cloth that has been dipped in a solution of mild liquid detergent and water, then wrung dry. Wipe dry after cleaning.

To reduce static electricity and dust build-up, wipe outer surface of cleaner and attachments.

Wash attachments in warm soapy water, rinse and air dry. **Do not clean in dishwasher.**



CAUTION

Do not use attachments if they are wet. Attachments used in dirty areas, such as under a refrigerator, should not be used on other surfaces until they are washed. They could leave marks.

DUST BAG CHANGING

TO REMOVE DUST BAG

WARNING

Always unplug power cord from electrical outlet before performing any service on vacuum.

Pull out on the bag cover release located near the top of the bag cover.

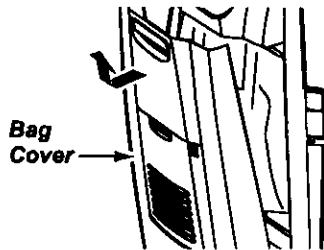
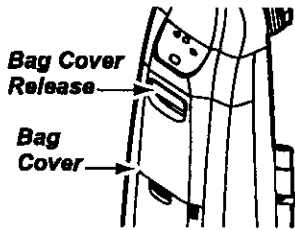

Pull the bag cover forward and lift up. Remove and lay aside.

Grasp the dust bag collar and pull gently, carefully removing the dust bag.

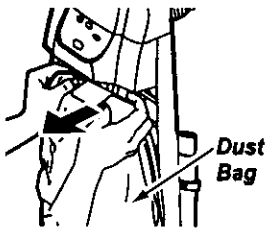

Throw away the used dust bag.

Do not reuse.

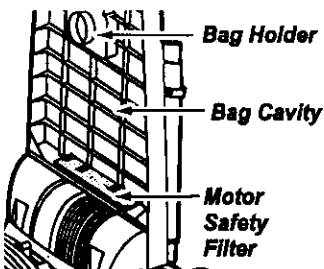

Check the bag holder and the motor safety filter. If either is blocked, check TROUBLE-SHOOTING.

CAUTION

NEVER REUSE A DUST BAG. Very fine materials, such as carpet freshener, face powder, fine dust, plaster, soot, etc. can clog the bag and cause it to burst before it is full. Change bag more often when vacuuming these materials.

TO REPLACE DUST BAG

Unfold the new dust bag. Fold the safety seal tab on the new dust bag away from the opening that fits on the bag holder.

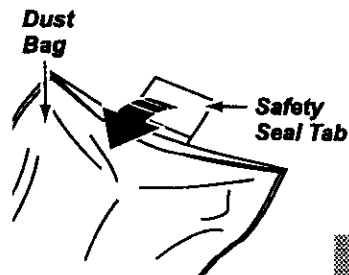

NOTE: See PARTS AND FEATURES for bag number.

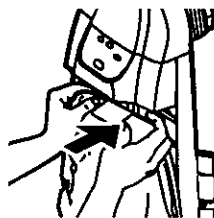

Insert the dust bag onto the bag holder completely by holding the bag collar.

Place the dust bag collar into position.

Tuck the bag behind each of the four bag retention corner flaps shown here. Be sure the bottom and sides of the dust bag are completely within bag cavity prior to replacing the bag cover.

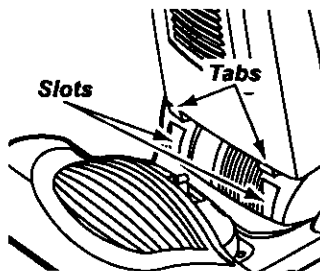
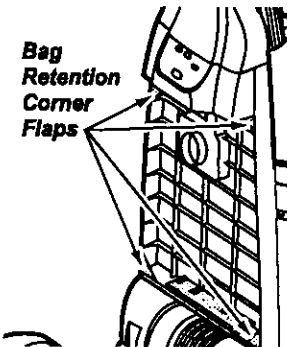

Position the bag cover so its positioning tabs fit into the body positioning tab slots.

Close the bag cover.

You will hear a distinct snap when cover is securely closed.

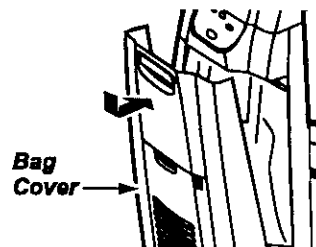

Check to see that the dust bag is fully enclosed in the bag cover.

English

FILTER CHANGING

Check motor safety filter frequently and change when dirty.



WARNING

Electrical Shock Hazard

Unplug power cord from electrical outlet. Do not operate the cleaner without the motor safety filter. Be sure the filter is dry and properly installed to prevent motor failure and/or electrical shock.

Remove the dust bag as outlined in the DUST BAG CHANGING section.

MOTOR SAFETY FILTER ELECTROSTATIC

1. This white & grey filter must be replaced when dirty. It should be replaced regularly depending on use conditions. **The filter CANNOT be washed as it will lose its dust trapping ability.**

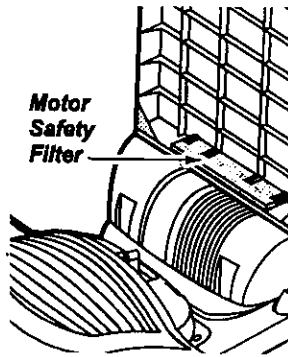

Note: See PARTS AND FEATURES for motor safety filter number.

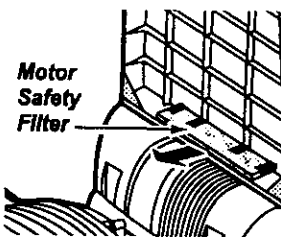

2. If the filter, located in the bottom of the bag cavity, is dirty, remove it by pulling forward out from under the ribs.

3. Replace the filter, **white side up**, by sliding it back into place under the ribs in the bag cavity.

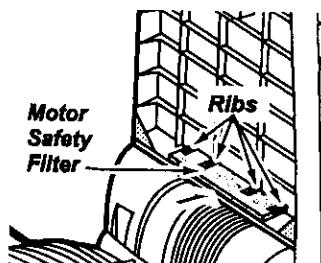

Replace the bag as outlined in the DUST BAG CHANGING section.

EXHAUST FILTER HEPA



WARNING

Do not operate without exhaust filter.

The exhaust filter cartridge must be replaced when dirty. It should be replaced regularly depending on use conditions. **The filter CANNOT be washed as it will lose its dust trapping ability.**

Note: See PARTS AND FEATURES for the exhaust filter number.

Slide the exhaust filter cover release down. Pull out on exhaust filter cover to remove from bag cover.

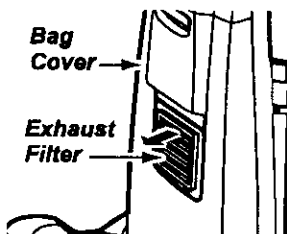
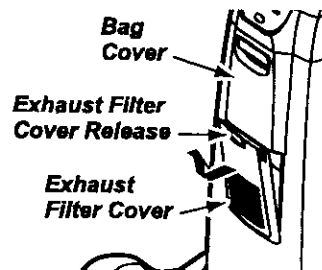

Remove the exhaust filter cartridge from the bag cover.

Replace the exhaust filter cartridge, carefully positioning it so that it fits into the bag cover. **The grey edge of the filter should be facing away from the operator.** Push only on filter cartridge frame, not on filter itself.

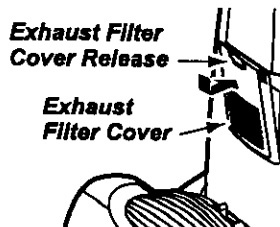
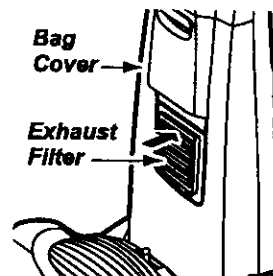

Replace the exhaust filter cover and secure the latch by pushing it upward.

LIGHT BULB CHANGING



WARNING

Electrical Shock Or Personal Injury Hazard

Disconnect electrical supply before servicing or cleaning the unit. Failure to do so could result in electrical shock or personal injury from cleaner suddenly starting.

TO REMOVE LIGHT BULB

Disconnect power cord from electrical outlet.

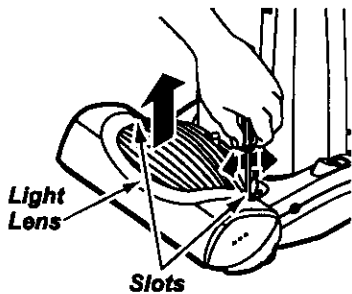

Pry light lens out at slot in rear as shown on both sides. Rotate lens up and lift off.



CAUTION

Do not use a bulb rated over 9W (13V). During extended use, heat from the bulb could overheat surrounding plastic parts.

Remove the light bulb by pulling straight out.

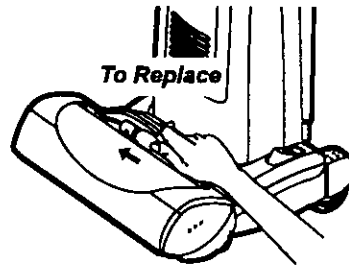
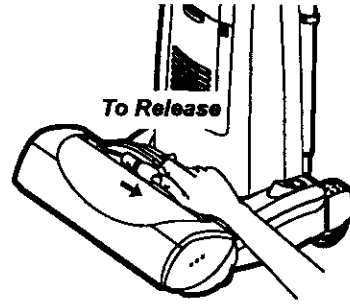

To replace the light bulb carefully insert fully into slot.

ENGLISH

Note: See PARTS AND FEATURES for bulb number.



CAUTION

Do not plug in or turn on until the vacuum is completely reassembled.

To replace light lens, place tabs at front of lens into slots. Rotate lens down and snap into place.

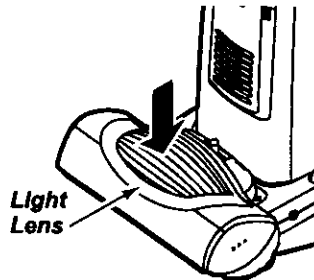

AGITATOR CLEANING

To maintain efficient cleaning, the agitator must be kept free of carpet pile, string, or hair build-up. After every 7 to 10 uses, unplug and turn vacuum over and check agitator for string and hair build-up.

Use a scissors to remove any build-up entangled around the agitator.

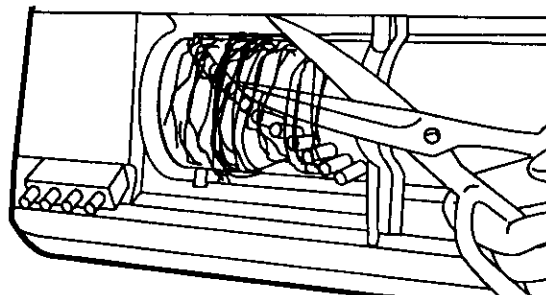

CLOG REMOVAL

Always follow all safety precautions when cleaning and servicing the vacuum cleaner.



WARNING

Electrical Shock Or Personal Injury Hazard

Disconnect electrical supply before servicing or cleaning the unit. Failure to do so could result in electrical shock or personal injury from cleaner suddenly starting.

If the cleaner does not seem to have adequate suction, first check if the dust bag is full or if a filter is clogged. See DUST BAG CHANGING and FILTER CHANGING.

If the bag and filter areas are free of clogs, check the hose area. Remove the lower end of the stretch hose from the cleaner by grasping the hose collar, twisting, and pulling straight out.

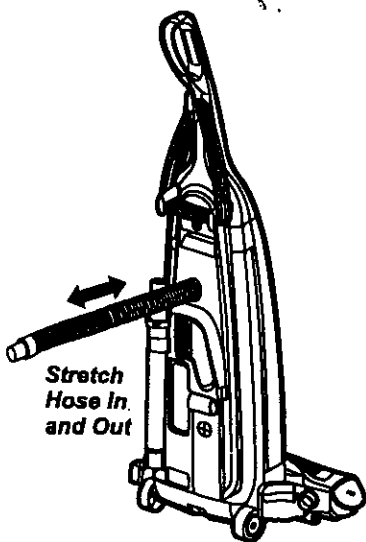

Plug in the vacuum and turn it on. Stretch the hose to maximum length and then allow the hose to return to its storage length.

Re-insert the hose into the opening on the lower body from which it was removed. Press firmly to assure connection.

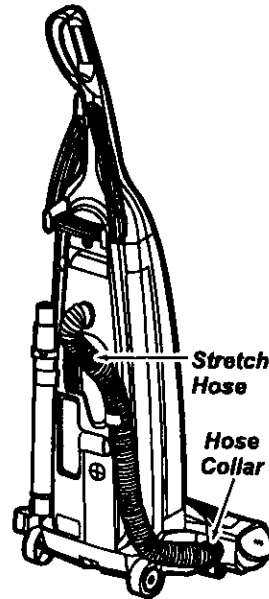

WARNING

Personal Injury Hazard

DO NOT place hands or feet underneath the unit at any time.

If the bag and filter areas and the hose areas are free of clogs, disconnect the hose from the nozzle pipe and check the nozzle pipe for clogging. Clean the agitator according to the instructions in the AGITATOR CLEANING section.

Return the cleaner to the upright position before plugging into an electrical outlet.

TROUBLESHOOTING

Review this chart to find do-it-yourself solutions for minor performance problems. Any service needed, other than those described in this owner's manual, should be performed by an authorized service representative.



WARNING Electrical Shock Hazard

Disconnect electrical supply before servicing or cleaning the unit. Failure to do so could result in electrical shock or personal injury.

PROBLEM	POSSIBLE CAUSE	POSSIBLE SOLUTION
Cleaner won't run.	<ol style="list-style-type: none"> 1. Unplugged at wall outlet. 2. Tripped circuit breaker/blown fuse at household service panel. 3. On/Off switch not turned ON. 4. Thermal protector tripped. 	<ol style="list-style-type: none"> 1. Plug in firmly, push On/Off switch to ON. 2. Reset circuit breaker or replace fuse. 3. Push On/Off switch to ON. 4. Allow vacuum to cool, then reset Thermal protector (page 12).
Poor job of dirt pick-up.	<ol style="list-style-type: none"> 1. Full or clogged dust bag. 2. Wrong pile height setting. 3. Worn agitator. 4. Clogged nozzle or bag holder. 5. Clogged hose. 6. Hole in hose. 7. Hose not inserted fully. 8. Motor protection system activated. 9. Dirty filters. 	<ol style="list-style-type: none"> 1. Change bag, (page 15). 2. Adjust setting, (page 7). 3. Take to your nearest Sears Service Center. 4. Check CLOG REMOVAL. (page 18). 5. Check for clogs, (page 18). 6. Take to your nearest Sears Service Center. 7. Insert hose fully, (page 10). 8. Check for clogs, (page 18). 9. Change filters, (page 16).
Cleaner picks up moveable rugs or pushes too hard.	<ol style="list-style-type: none"> 1. Wrong pile height setting. 	<ol style="list-style-type: none"> 1. Adjust setting, (page 7).
Light won't work.	<ol style="list-style-type: none"> 1. Burned out light bulb. 	<ol style="list-style-type: none"> 1. Change light bulb, (page 17).
Agitator does not turn.	<ol style="list-style-type: none"> 1. Agitator On/Off selector in OFF position. 2. Handle in full upright position. 3. Hose removed from nozzle. 4. Agitator Overload tripped. 5. Thermal protector tripped. 	<ol style="list-style-type: none"> 1. Move selector to the ON position, (page 8). 2. Move handle from upright position (page 7). 3. Reattach hose to nozzle (page 10). 4. Reset Agitator Overload (page 12). 5. Allow vacuum to cool, then reset Thermal protector (page 12).
Performance indicator, some models, is red.	<ol style="list-style-type: none"> 1. Full or clogged dust bag. 2. Dirty filters. 3. Clogged airflow passage. 4. Certain attachment tools. 	<ol style="list-style-type: none"> 1. Change bag, (page 15). 2. Change filters, (page 16). 3. Clear clog from airflow passage, (page 18). 4. This is normal. Light should go off when tool is removed.
Air flow restricted with attachment use. Sound changes.	<ol style="list-style-type: none"> 1. Attachment use restricts air flow. 2. New carpet fuzz clogged air path. 	<ol style="list-style-type: none"> 1. Check ATTACHMENTS, (page 8) 2. Check CLOG REMOVAL and clean hose, (page 18).
Dirt Sensor, some models, will not work.	<ol style="list-style-type: none"> 1. Dirty optic cells. 	<ol style="list-style-type: none"> 1. Clean optic cells. (page 13).

ENGLISH

Get it fixed, at your home or ours!

Your Home

For repair - **in your home** - of all major brand appliances, lawn and garden equipment, or heating and cooling systems, **no matter who made it, no matter who sold it!**

For the replacement parts, accessories and owner's manuals that you need to do-it-yourself.

For Sears professional installation of home appliances and items like garage door openers and water heaters.

1-800-4-MY-HOME[®] Anytime, day or night
(1-800-469-4663) (U.S.A. and Canada)

www.sears.com

www.sears.ca

Our Home

For repair of carry-in products like vacuums, lawn equipment, and electronics, call or go on-line for the nearest **Sears Parts and Repair Center.**

1-800-488-1222 Anytime, day or night (U.S.A. only)

www.sears.com

To purchase a protection agreement (U.S.A.) or maintenance agreement (Canada) on a product serviced by Sears:

1-800-827-6655 (U.S.A.)

1-800-361-6665 (Canada)

Para pedir servicio de reparación a domicilio, y para ordenar piezas:

1-888-SU-HOGARSM
(1-888-784-6427)

Au Canada pour service en français:

1-800-LE-FOYER^{MC}
(1-800-533-6937)
www.sears.ca

SEARS

© Sears, Roebuck and Co.

® Registered Trademark / TM Trademark / SM Service Mark of Sears, Roebuck and Co.

® Marca Registrada / TM Marca de Fábrica / SM Marca de Servicio de Sears, Roebuck and Co.

^{MC} Marque de commerce / ^{MD} Marque déposée de Sears, Roebuck and Co.