

This Owner's Manual is provided and hosted by [Appliance Factory Parts](#).

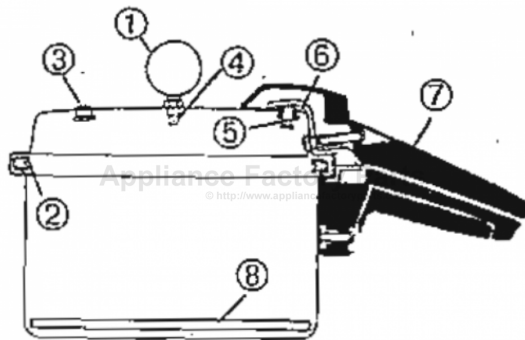

# Mirro M-0646 Owner's Manual

[Shop genuine replacement parts for Mirro M-0646](#)



[Find Your Mirro Pressure Cooker Parts - Select From 109 Models](#)

----- Manual continues below -----

June '04

# Table of Contents

English Section . . . . .	4-32	Fish & Seafood . . . . .	19
Safety Rules & Safeguards . . . . .	4	Vegetables . . . . .	20-22
Getting to Know Your Cooker . . . . .	5	Fruits . . . . .	22
How to Cook With Your Cooker . . . . .	6	Soup & Chowder . . . . .	23
How to Operate Your Cooker . . . . .	7	Desserts . . . . .	24
Cooker Problems . . . . .	8	Canning . . . . .	25-31
Cleaning & Care . . . . .	9	Canning Problems . . . . .	27
Questions & Answers . . . . .	10	More Info on Canning . . . . .	27
Recipes & Adapting Recipes . . . . .	11	Food Info & Charts . . . . .	28-29
Meat & Poultry Timetable . . . . .	11	Sterilization . . . . .	31
Beef . . . . .	12-14	Replacement Parts . . . . .	32
Pork . . . . .	15-16	Spanish Section . . . . .	33-63
Veal & Lamb . . . . .	17	French Section . . . . .	64-94
Poultry & Game . . . . .	18	Parts Order Form . . . . .	95-96

## Caution!

### Read This Book Before Using.

IMPROPER USE MAY RESULT IN SCALDING INJURY. DO NOT OVERFILL. FOR PROPER CLOSURE, COVER HANDLE MUST BE DIRECTLY ABOVE PAN HANDLE. DO NOT ATTEMPT TO

OPEN COVER UNTIL PRESSURE CONTROL IS REMOVED AND LOCK LEVER IS RELEASED FROM PAN HANDLE. NEVER FORCE HANDLES OPEN.

### Be Sure You Understand All Operating Instructions Before Using Cooker.

See pages 4-10 for important information about operating and repairing cooker.

## Five-Year Limited Warranty

### Our Promise to You:

This Mirro Company product is warranted against defects in workmanship and material for a period of **FIVE YEARS** from the date that the product is originally purchased. If this product becomes defective within the warranty period, Mirro will repair it or replace it.

This warranty is not applicable to the gasket and overpressure plug or damage to the product resulting from misuse, accidents or alterations to the product. **MIRRO SHALL NOT BE LIABLE FOR INCIDENTAL OR CONSEQUENTIAL DAMAGES, HOWEVER CAUSED.** Some states do not allow the inclusion or limitation of incidental or consequential damages, so the above exclusion may not apply to you.

If service becomes necessary within the warranty period, return the product, along with a description of the claimed defect, to:

**MIRRO COMPANY**  
1512 Washington Street  
P.O. Box 1330  
Manitowoc, WI 54221-1330

Mirro will refund the postage and insurance charges, if any, you prepaid if the service work requested is covered by this warranty.

This warranty gives you specific legal rights and you may also have other rights which vary from state to state.

See pages 10, 32 and 95 for Questions and Answers and repair instructions.

# IMPORTANT SAFEGUARDS

## Pressure Cooker Safety Rules

Pressure cookers work differently from conventional pots and pans and require some special safety practices in addition to normal cooking safety precautions.

1. Before using your pressure cooker, read all instructions and be sure you understand them.
2. Do not touch hot surfaces. Use handles or knobs.
3. Use your pressure cooker on top of the stove only—never put it in the oven.
4. Be very careful when using the pressure cooker near children. Supervise children closely.
5. Before use, always check that the vent tube in the cover is open and that the pressure control is not clogged.
6. Never cook foods that tend to foam or froth, as they may clog the vent tube and pressure control. Foods that are especially likely to do this are listed below.

### Never cook these foods in the pressure cooker:

- applesauce
- oatmeal or other cereals
- noodles, macaroni, spaghetti or other pasta
- split peas
- pearl barley
- cranberries or rhubarb

If the vent tube or pressure control is blocked, the pressure may seem to be down when the pressure control is removed, even though the contents may be above the boiling point and under pressure for a long time after the cooker is removed from heat.

7. Never fill the cooker more than  $\frac{3}{4}$  full. If you are cooking food that expands during cooking (such as rice or dried vegetables), **fill the cooker only  $\frac{1}{2}$  full, see "food preparation instructions"**
  8. This appliance cooks under pressure. Improper use may result in scalding injury. Make certain unit is properly closed before operating. See **How to Operate Cooker**, page 7.
  9. Never try to open your pressure cooker until the unit is thoroughly cool and the internal pressure is down. When the pressure is down, the cover should turn easily.
- Never try to force open the cover if it seems locked tight.** See **Cooker Problems**, page 8.
10. If the vent tube becomes blocked while cooker is being heated, the pressure control will stop jiggling or rocking. **Immediately turn off heat and allow cooker to cool.**

**WARNING: If vent tube is blocked, overpressure plug may release and hot food and steam spray out. Keep face and head away from cooker.**

When cooker is thoroughly cool, clean the vent tube and check the contents to find out why the blockage occurred. **Correct the problem before you resume cooking.**

11. If the vent tube becomes blocked during cooking, and you do not notice the problem, the overpressure plug will release.

**Immediately turn off heat and allow cooker to cool.**

**WARNING: If overpressure plug releases, cooker may spray scalding hot steam and food. Keep away until cooker has cooled.**

**Never reuse a blown overpressure plug.** Replace it with a new plug. See "Overpressure plug has released" in **Cooker Problems**, page 8.

12. Never use your pressure cooker for pressure frying with oil and never "broast" (pressure cooking with oil or shortening instead of water) in your cooker.
13. Never use your pressure cooker for other than its intended use.
14. **Always remove the gasket** before using the cooker as a conventional (non-pressurized) covered pan without the pressure control. If you leave the gasket in, some pressure may develop in the cooker. Without the gasket, pressure will not develop.
15. Be extremely careful when moving a pressure cooker full of hot liquids.

## IMPORTANT

**Steam may sometimes escape through lock lever and around cover handle. This is not a malfunction as steam escapes until lock lever is fully engaged. If steam continues for several minutes, tap cover handle lightly or open and reclose cooker to ensure proper gasket seal.**

**If pressure cannot be maintained in cooker, check gasket for replacement.**

**The overpressure plug will release when vent tube is blocked. Do not reuse a blown overpressure plug. Replace with a new plug. To install, push rounded portion through underside of cover. Indented portion will be visible from underside of cover when correctly installed.**

**If unable to obtain replacement parts from a local dealer, use order form on page 96 and send directly to manufacturer.**

IF YOU SHOULD HAVE ANY QUESTIONS ON THE PROPER OPERATION OF YOUR PRESSURE COOKER, PLEASE CALL 1-800-527-7727. ATTENTION: CONSUMER CENTER.



This symbol on the product's nameplate means it is listed by UNDERWRITERS' LABORATORIES, INC.

## SAVE THESE INSTRUCTIONS

# Getting to Know Your Pressure Cooker

To use your pressure cooker properly, you must be familiar with its parts and features. Many of these parts are common to all models of cookers, but some differ for different models.

This information covers these models:

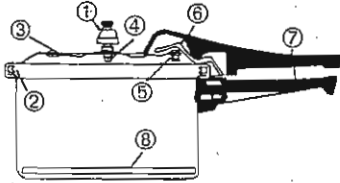

4- and 6-quart (3.8- and 5.7-liter) models with single control.

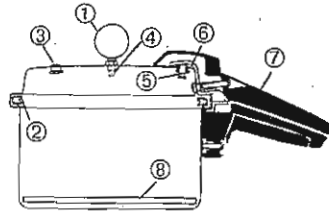

4- and 6-quart (3.8- and 5.7-liter) models with selective control.

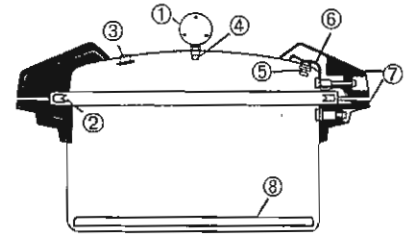

8-, 12-, and 22-quart (7.6-, 11.4-, and 20.9-liter) models.

## Automatic Pressure Control (Selective or Single)

These precision-made controls never require adjustment or testing for accuracy. They automatically maintain the proper pressure for cooking. Your cooker has one of two types of pressure controls:

### Selective Control

The selective control lets you select one of three pressure settings:

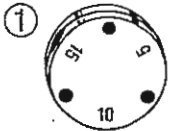

Pressure	Cooking Temperature
5 lbs. (35 kPa)	228° F (109° C)
10 lbs. (70 kPa)	240° F (115° C)
15 lbs. (103 kPa)	250° F (121° C)

When the cooker reaches the proper temperature, the selective control jiggles audibly.

### Single Control

The single control has one pressure setting:



Pressure	Cooking Temperature
15 lbs. (103 kPa)	250° F (121° C)

When the cooker reaches the proper temperature, the single control rocks gently.

## V-Type Self-Sealing Gasket

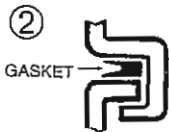

The gasket inside the cover automatically seals the cover when the cooker is closed according to directions and brought under operating pressure. The gasket may easily be removed for cleaning.

## Overpressure Plug

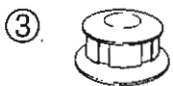

The overpressure plug releases if the vent tube becomes blocked and cooker develops too much pressure. This is a protection that permits excess pressure to be released safely. If you follow directions for using the cooker properly, the plug will probably never release. To replace a blown plug, see page 32.

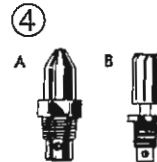

## Vent Tube

Your cooker has one of two types of vent tubes, to match the two types of pressure controls:

- A. Selective** (5-, and 10-, and 15-lb.) control
- B. Single** (15-lb.) control.



## Lift Pin Assembly

As the pressure increases and decreases inside the cooker, the lift pin moves the lock lever in the handle.

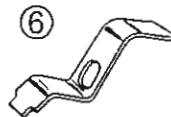

## Lock Lever

When the cover is properly closed and pressure begins to rise in the cooker, the lock lever drops into the locked position in the bottom handle. It releases and unlocks when the pressure goes down.

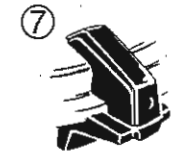

## Handles/Grips

**8-, 12-, and 22-quart (7.6-, 11.4-, and 20.9-liter) models**

These models have matching grips on each side of the cover and pan. To close, rotate cover clockwise until the grips on the cover are **directly over the grips on the pan**.

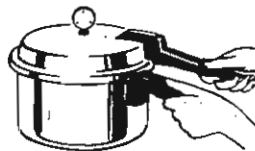

**4- and 6-quart (3.8- and 5.7-liter) models**

These models have long handles, one on the cover and one on the pan. To close, rotate cover clockwise until the cover handle is **directly over the pan handle**.

To open either type, **wait until pressure is down, then gently rotate cover counter-clockwise**.

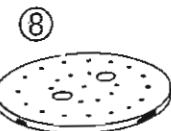

## All-Aluminum Cooking Rack

The rack is used for canning and steaming foods and whenever directions specify its use.



## Cover Positive Stop-Notch

There is a stop-notch located on the flange of the pan. Specifically on the first lug to the right of the handle. The stop-notch is a designed part of the pressure cooker/canner flange system. The purpose of the stop-notch is to be a positive stop when you rotate your cover to the closed position.

# How to Cook With Your Pressure Cooker

## General Tips—Read Before You Cook

### Recipes and Timetables

Pressure cookers use different recipes from conventional pans. This book includes recipes and timetables for many popular foods. The quantities of ingredients used depend on the size of the cooker, and the time needed to cook the food properly depends on the pressure used. For this reason, the recipes and timetables have information in several columns to correspond to different pressures and sizes of cookers.

Ingredient amounts are listed in four columns, corresponding to different size cookers and U.S. and metric measures (metric measures are rounded):

- 4-quart cooker, U.S. measure
- 6- or 8-quart cooker, U.S. measure
- 3.8-liter cooker, metric measure
- 5.7- or 7.6-liter cooker, metric measure

The timetables give minutes needed to cook in two columns, corresponding to two different pressures:

- 10 lbs. pressure
- 15 lbs. pressure

**CAUTION: Be sure you use the columns for your cooker and the pressure you are using.**

Cooking times are only guidelines, because meats and vegetables vary in tenderness. Adjust cooking times to your taste.

To use these recipes in one of the larger canners, follow this guide:

#### **12-quart (11.4-liter) canner:**

**double** the recipe for the 6- to 8-quart (5.7- to 7.6 liter) canner and

**increase the water** by one cup (250 mL).

#### **22-quart (20.9-liter) canner:**

**triple** the recipe for the 6- to 8-quart (5.7- to 7.6-liter) canner and

**increase the water** by one cup (250 mL).

**CAUTION: If you reduce any of the recipes in this book, you must still use the FULL AMOUNT of liquid called for.**

### Canning

To pressure can, you must use a model with a selective control, because canning is done only at the lower pressures (5 and 10 lbs.).

**CAUTION: Do not attempt to pressure can with a single-pressure control or a selective control set at 15 lbs.**

See specific instructions and recipes for canning on pages 25-31.

### Cooking and Canning at High Altitude

At altitudes above 1,000 feet (300 meters), increase pressure by 5 lbs. For example, if the recipe calls for 10 lbs. of pressure, cook at 15 lbs. If the recipe calls for 15 lbs. of pressure, increase cooking time slightly.

## How to Operate Cooker

Your pressure cooker is very simple to operate. Follow these steps.

### 1. Check to make sure vent tube is clear.

Hold the cover up to a light. You should be able to see light through the vent tube. If you cannot see light, the tube may be blocked. Insert a piece of wire into the tube and run it gently in and out until you are sure the tube is clear.

### 2. Put food in the cooker, add the required amount of water, and wipe the rim of the pan.

At first, until you become familiar with your cooker, use a little more water than is called for.

### 3. Place gasket in position inside the cover and set the cover on the pan with the handles apart and the arrow on the cover pointing to the center of the pan handle.

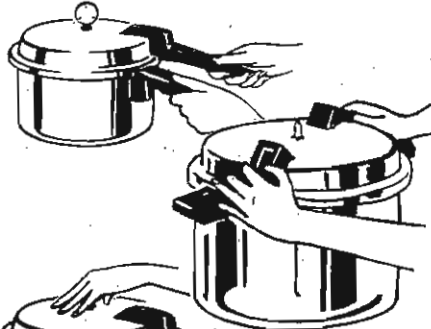

### 4. Rotate cover clockwise until handles (or grips) on the cover are directly over handles (or grips) on the pan.

If a new gasket makes closing difficult, press down on the cover with one hand while rotating the cover with the other hand.

**WARNING: Handles or grips on cover must be directly over handles or grips on pan. Never attempt to cook with handles or grips in any other position.**

### 5. Set pressure control over vent tube. For selective pressure controls, be sure to align the control so that hole corresponding to the desired pressure is directly over the vent tube.

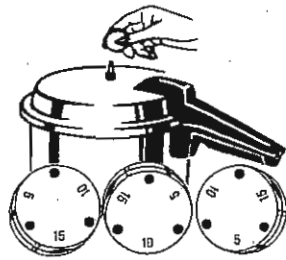

### 6. Unless the recipe directs otherwise, set the cooker with contents over high heat.

Some recipes specify medium heat at this time.

As the cooker heats and pressure builds up, the lock lever will drop into the locked position in the pan handle.

Some steam may appear around the handle during heating and you may hear a hissing sound as air and steam escape from the cooker. **This is normal and will stop before cooker reaches operating pressure.**

### 7. When pressure control begins to jiggle and sputter (selective control) or rock (single control), reduce heat until selective control jiggles about 1 to 4 times per minute or single control rocks gently.

The pressure control jiggles or rocks when the cooker reaches the selected pressure. Lowering the heat so that the selective pressure control jiggles (1-4 times per minute) or single control rocks occasionally maintain the proper pressure while preventing excessive fuel use and excessive loss of cooking liquid as steam. Experience will teach you what setting on your stove will maintain pressure. Generally a setting of "medium" or "low" will be right.

How long it takes to bring the pressure up to the point where the pressure control jiggles or rocks depends on the size of the cooker and the amount of food being cooked

or canned. A small cooker may take only 5 or 10 minutes to reach pressure, while a large pressure cooker with a full load may take 45 minutes to an hour.

**CAUTION: If steam escapes in a steady stream after heat is reduced, gently nudge the pressure control to reset it so that it jiggles intermittently or rocks gently.**

### 8. Count cooking time from the first jiggle or rock of the pressure control.

### 9. When food has cooked under proper pressure for the required length of time, remove cooker from heat and reduce pressure.

**CAUTION: Do not remove pressure control until pressure is completely reduced.**

You can reduce pressure in three ways:

- **fast**—for fresh vegetables and fish.

Run cold water over the cooker or place it in a pan of cold water. Depending on the amount of food in the cooker, it will take 15-60 seconds for pressure to go down fully.

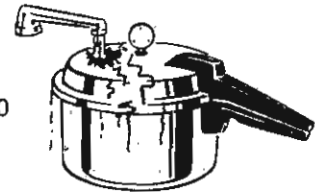

- **normally**—for canning.

Let the cooker cool slowly to room temperature. This will take 25-35 minutes for a small cooker, 40-45 minutes for the largest canner.

- **combination**—for meats and dried vegetables.

Let the cooker cool normally at room temperature for 5 minutes, then place the cooker under cold water to reduce the remaining pressure.

As the pressure is reduced, air will re-enter the cooker, making a hissing or squealing sound. When the hissing stops, the lock lever in the cover will release.

### 10. When the pressure is reduced, nudge the pressure control to make sure pressure is down, and if it is, remove the pressure control.

**WARNING: Escaping steam can scald you, and the pressure control may be hot. Protect your hand with a pot holder or oven mitt.**

**CAUTION: If steam spurts out when control is nudged, pressure is not completely down. Continue to cool the cooker.**

To remove the selective control, insert the tine of a fork into one of the holes (see illustration) and lift.

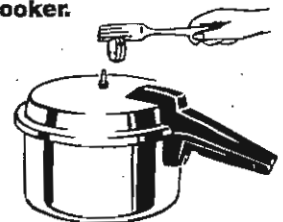

**WARNING: The pressure control may be hot. Handle with care.**

To remove the single control, using a pot holder or oven mitt, grasp the plastic knob and lift straight up.

### 11. Open the cover by turning the cover counter-clockwise until handles or grips are apart and cover is in the open position.

When the pressure is fully reduced, the cover should slide open easily.

**WARNING: Never tug at the handles or try to force them apart if they seem locked. The lock lever will not release if any steam pressure remains in the cooker. Cool the cooker until pressure is fully reduced.**

# Cooker Problems

## ***Problem: Pressure will not build up.***

Steam continues to escape around the edge of the cover or around the handle, and pressure does not increase to make the pressure control jiggle or rock.

### ***Causes and Remedies:***

1. Food particles have lodged in lift pin cavity, preventing it from sealing and actuating the lock lever.

#### **Reduce the pressure as instructed in the recipe.**

When pressure is fully down, remove the pressure control and open the cooker. Clean the cover (see page 9) and try again.

2. Gasket or edge of cover is wet, with water escaping as steam and giving the appearance of a leak.

#### **Reduce the pressure as instructed in the recipe.**

When pressure is fully down, remove the pressure control and open the cooker. Remove the gasket from the cover, and wipe the gasket, the pan rim, and the inside of the cover. Dry thoroughly and start over.

3. Gasket has shrunk, so that it does not form a tight seal.

#### **Reduce the pressure as indicated in the recipe.**

When pressure is fully down, remove the pressure control and open the cooker. Remove the gasket from the cover and stretch it gently to its original size, replace it and try again. If gasket continues to leak, replace it.

## ***Problem: Cover is stuck closed.***

Cover won't turn easily so it can be removed.

### ***Causes and Remedies:***

#### **WARNING: Check these possible causes IN THE ORDER GIVEN.**

1. Cooker is not fully cooled, so pressure is not fully down, preventing the lock lever from releasing.

#### **Cool cooker until pressure is fully down.**

2. Vent tube is blocked, so pressure cannot be fully reduced.

#### **Cool cooker until you are sure it is thoroughly cool.**

Insert a piece of wire into vent tube and run it in and out until you are sure vent tube is clear.

3. Food such as meat broth has collected on the gasket and "glued" it tight when the pressure was reduced.

**With the pressure control off** the cover, put the cooker back on low heat until steam escapes from vent tube. Take the cooker off the heat and let it cool until steam stops coming from the vent tube. Then remove the cover.

Often, reheating for a short time will soften the material and allow the cover to be removed.

4. Food such as soup has boiled up and gotten between the gasket and the rim of the cooker, causing it to stick.

Reheating, as in step 3, often will soften the food material and allow the cover to be removed.

5. Gasket has stretched, so that it no longer fits properly.

If the cooker is thoroughly cool, the vent tube is clear, and pressure is fully down, the gasket may have stretched until it no longer fits properly.

#### **Note: If this is the case, the cover will have been hard to close as well as hard to remove.**

Replace gasket with a new one.

## ***Problem: Lock lever does not release after pressure is down.***

### ***Causes and Remedy:***

Pressure is not fully down.

**Cool cooker to room temperature.** Remove pressure control, then slip a knife blade between the cover handle and the pan handle and slip the lock lever up.

#### **WARNING: If steam escapes when the lock lever is pushed up, the pressure is not fully down. Cool to room temperature.**

## ***Problem: Overpressure plug has released.***

### ***Causes and Remedy:***

The vent tube is blocked.

If the vent tube becomes blocked, and this condition goes unnoticed, excess pressure can build up in the cooker, causing the overpressure plug to release.

1. Cool the cooker and, when cool, remove cover.
2. Inspect the cover and pan for damage.
3. Clean the vent tube by inserting a piece of wire into the vent tube and running it in and out until you are sure the tube is open.
4. Install a **new** overpressure plug. To install, push the rounded end of the plug through the underside of the cover. When properly installed, the indented part of the plug will be visible from the underside of the cover.

#### **WARNING: Never reuse a blown overpressure plug. Replace with a new plug.**

# Cleaning and Care of Your Pressure Cooker

Before using your cooker the first time, wash it thoroughly in hot soapy water. Rinse thoroughly and dry.

## Interior

To make cleaning easier, run warm water into your cooker immediately after removing food. Wash in hot, soapy water.

Remove food stains and hard-water stains with a soap-filled steel wool pad; or bring to a boil one quart (1 L) of water, and 2 level tablespoons (30 mL) of cream of tartar, and let that solution boil in the cooker (**cover off**) for a few minutes. You can also use a solution of equal amounts of water and vinegar. After cleaning, rinse thoroughly and dry.

## Exterior

Clean the exterior occasionally with silver polish. Remove water stains on the cover with a mild cleansing powder or silver polish. Do not soak cover or pan in water or wash in the dishwasher, as this will dull the outside polished finish. The outside of the pan bottom may be scoured with a steel wool pad if necessary.

**CAUTION: Never beat a spoon, potato masher, or other utensil on the rim of the cooker. Any mar or dent in the rim may prevent a good seal from forming and prevent the cooker from pressurizing properly.**

## Gasket

After each use of the cooker, remove the gasket from the cover. Wash it thoroughly in hot, soapy water, and rinse and dry it thoroughly. Then slip the gasket back in place in the cover so the cooker is always ready to use.

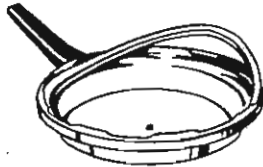

## Lift Pin and Lock Lever

Always wash the cover thoroughly after each use. Run hot water around all openings in handle to keep lift pin and lock lever free of grease or food particles that could keep them from operating properly.

**Note: If moisture remains inside handle, steam may appear around handle when the cooker is next used. This is normal.**

## Vent Tube

After washing and rinsing the cover and always before using, hold it up to the light to see if the vent tube is clear. You should be able to see light through the vent tube. If you cannot, the tube may be blocked. Carefully insert a piece of wire in the vent tube and run it gently in and out to be sure the tube is clear and unobstructed. Then rinse again in hot water.

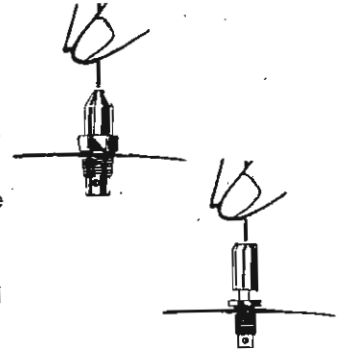

**WARNING: The vent tube must be open. Always check it before use.**

## Pressure Control

Usually the pressure control will remain clean because it is "steam-cleaned" during operation. However, washing in hot, soapy water followed by thorough rinsing will not harm it.

**CAUTION: Be sure that stove top is level. If the top is tilted, the pressure control may bind and not operate properly.**

## Storage

Store cooker with cover **off** or **upside-down** on cooker. Do not store with cover and gasket closed tight on pan.

## Questions and Answers

### ***How can I tell if the correct pressure is being maintained?***

As long as the pressure control jiggles (about 1-4 times per minute) or rocks gently, you can be sure the correct pressure is being maintained.

The control is precision-made and accurate. It never needs to be tested or adjusted for accuracy.

The most common mistake is using too much heat so that the control jiggles too often or rises on the vent tube and emits a steady flow of steam. Too much heat results in excessive loss of cooking liquid.

### ***Sometimes a trickle of moisture appears around the vent tube or the overpressure plug. Is this normal?***

As the pressure is brought up, steam contacts the cold metal of the tube and condenses as water. The moisture usually disappears when the control jiggles and the metal has fully heated.

### ***What makes the overpressure plug release?***

The overpressure plug is a safety feature to release pressure if the vent tube becomes blocked and excess pressure develops. If you follow the directions in this manual, you will probably never have the overpressure plug release.

**WARNING: Never reuse a blown overpressure plug.**

**Replace it with a new one.** (For installation, see "Cooker Problems" page 8.)

### ***Why does steam and moisture escape around the rim of the cooker and the cover handle?***

Moisture inside the handle or between the gasket and cover will escape as steam when the cooker is heated. The steam should stop as the pressure builds up. If it does not stop, follow instructions in "Cooker Problems" section under "Pressure will not build up" page 8.

### ***How can I tell if my cooker needs a new gasket?***

If steam escapes around the rim of the cooker and pressure will not build up (and the lift pin and locking lever are clean), you probably need a new gasket.

If a gasket has become hard and shiny after long use, replace it.

If gasket has stretched so that it no longer fits easily into the cover, replace it.

### ***When my cooker was new, the cover fit very snugly. Now the cover slides on and off easily. Should I stretch the gasket?***

No. As long as pressure builds up properly and the cooker operates normally, the gasket is fine. As the cooker is heated, the gasket expands to seal the rim.

After a gasket has been under pressure a few times, it naturally shrinks a little. Stretch it **only** if it fails to hold pressure.

### ***What causes a squeal or hissing sound sometimes when the cooker is cooled under running water?***

When the pressure is reduced quickly, it produces a vacuum inside the cooker. The noise you hear is air rushing in to fill the vacuum. It is normal and harmless.

You can minimize the noise by running a moderate stream of water on the rim of the cooker rather than directly on top.

### ***What makes a gasket stretch or swell?***

Sometimes, after a gasket has been used for a long time, it stretches so that it no longer fits properly. Replace it with a new one.

If a gasket stretches in less than a year, it is probably because of excess grease. Be sure to wash the gasket thoroughly after each use.

### ***What makes the cooker hard to close?***

In a new cooker, the gasket is often very snug fitting. Pressing down on the cover with one hand, while you open or close the cooker with the other, will often help. In a few instances, it may be necessary to lubricate the gasket with cooking oil or shortening for the first two or three uses.

**CAUTION: Do not lubricate gasket after the first two or three uses. Continued lubrication will cause the gasket to swell and not fit properly.**

If your cooker has seen extended use, the gasket may have stretched so that it no longer fits. Replace it with a new one.

### ***Are the pressure controls interchangeable on the three-pressure (selective) model cooker and the one-pressure (single) model cooker?***

No. Pressure controls are **not** interchangeable and must be used with the model of cooker for which they were intended.

### ***May I use a one-pressure (single) model cooker for canning?***

No. The one-pressure model can be used at 15 lbs. pressure only. Canning requires 5 lbs. and 10 lbs. also. See specific instructions for canning on pages 25-31.