

This Owner's Manual is provided and hosted by [Appliance Factory Parts](http://www.appliancefactoryparts.com).



PRESTO A403AD Owner's Manual

[Shop genuine replacement parts for PRESTO A403AD](#)



[Find Your PRESTO Pressure Cooker Parts - Select From 250 Models](#)

----- Manual continues below -----

PRESTO®

4- and 6-Quart Aluminum Pressure Cookers



©2006 by National Presto Industries, Inc.

Visit us on the web at
www.GoPresto.com

Instructions and Recipes

TABLE OF CONTENTS

Important Safeguards	2
Introduction	2
Getting Acquainted.....	3
How to Use	4
Important Safety Information.....	5
Care and Maintenance.....	6
Helpful Hints.....	8
Questions and Answers	9
Soups and Stocks	10
Seafood.....	13
Poultry	16
Meats	20
Vegetables	25
Dry Beans and Peas	29
Grains	31
Desserts	33
Recipe Index	36
Service and Parts Information	37
Warranty	37

This is a  Listed appliance. The following Important Safeguards are recommended by most portable appliance manufacturers.

IMPORTANT SAFEGUARDS

To reduce the risk of personal injury or property damage, basic safety precautions should always be followed, including the following:

1. **Read all instructions.**
2. Always check the vent pipe before use. Hold cover up to light and look through vent pipe to be certain it is clear.
3. Always check the air vent/cover lock to be sure it moves freely before use.
4. Do not fill pressure cooker over $\frac{2}{3}$ full. For soup, grains, and dry beans and peas which expand during cooking, do not fill cooker over $\frac{1}{2}$ full. Overfilling may cause a risk of clogging the vent pipe and developing excess pressure. See food preparation instructions.
5. Do not pressure cook applesauce, cranberries, rhubarb, cereals, pastas, dried soup mixes, or any dry beans and peas which are not listed on the chart on page 29. These foods tend to foam, froth, and sputter and may block the vent pipe, overpressure plug, and air vent/cover lock.
6. This appliance cooks under pressure. Improper use may result in scalding injury. Make certain pressure cooker is properly closed before operating; cover handle must be directly above the body handle. See “How To Use Instructions.”
7. Do not place the pressure cooker or attempt to pressure cook in a heated oven.
8. Extreme caution must be used when moving a pressure cooker containing hot liquids. Do not touch hot surfaces. Use handles or knobs.
9. Do not open pressure cooker until internal pressure has been completely reduced, air vent/cover lock has dropped, and no steam escapes when the pressure regulator is removed. See “How To Use Instructions.”
10. **Caution:** To ensure safe operation and satisfactory performance, replace the overpressure plug every time you replace the sealing ring or sooner if it becomes hard, deformed, cracked, worn, or pitted. It is recommended that the sealing ring and overpressure plug be replaced at least every two years.
11. Close supervision is necessary when the pressure cooker is used near children. It is not recommended that children use the pressure cooker.
12. When normal operating pressure is reached, the pressure regulator will begin to rock. Gradually lower the heat to maintain a slow, steady rocking motion. If the pressure regulator is allowed to rock vigorously excess steam will escape, liquid will be evaporated, and food may scorch.
13. **Caution:** Do not use pressure cooker on an outdoor LP gas burner or gas range over 12,000 BTU’s.
14. Do not use this pressure cooker for other than intended use.
15. Do not use this pressure cooker for pressure frying with oil.

SAVE THESE INSTRUCTIONS

THIS PRODUCT IS FOR HOUSEHOLD USE ONLY.

INTRODUCTION

Welcome to the world of pressure cooking. With your new Presto® Pressure Cooker, you’ll discover how fast and easy it is to prepare a wide variety of delicious foods—especially foods that emphasize good health and nutrition along with good taste.

The pressure cooker is perfect for the way we live and eat today. It’s ideal for preparing many of the lighter foods that help keep us healthy and fit. It preserves flavors and nutrients, tenderizes leaner cuts of meat and, best of all, it cooks foods three to ten times faster than ordinary cooking methods. And, it’s even possible to cook several foods in the pressure cooker at the same time without the flavors intermingling.

We have included recipes for some traditional family favorites that are especially well suited to the many advantages of pressure cooking. For your convenience, we have also provided nutritional information for all of the recipes in this book.

To help get started with your new pressure cooker, be sure to read the “GETTING ACQUAINTED” section beginning on the next page.

GETTING ACQUAINTED

Your pressure cooker is like a saucepan with a very special cover that locks in place. Air is automatically exhausted and steam is sealed inside creating pressure within the unit. Under pressure, internal temperatures in the cooker are raised above the normal boiling point of water, causing foods to cook faster. At 15 pounds of pressure, a temperature of 250° F. (or 121° C.) is reached inside the pressure cooker. These higher temperatures speed cooking and the moist steam atmosphere tenderizes meats naturally.

It is important to become familiar with the various parts of the pressure cooker (Fig. A) and to read the "HOW TO USE" section beginning on page 4 before using the unit for the first time.



Fig. A

Before the first use, remove the sealing ring (Fig. B) by simply pulling it out of the inside rim of the cover.

Wash sealing ring, cover, body, and cooking rack (Fig. A) in hot, sudsy water to remove any packaging material and white manufacturing lubricant. Rinse all parts with warm water and dry. Then, replace the sealing ring, being careful to fit it under the stop tabs and the lock pin (Fig. B) which are located on the inside rim of the cover.



Fig. B

HOW TO USE

To assure the very best results every time, carefully follow these step-by-step instructions for pressure cooking. You may find it helpful to refer back to Fig. A on page 3.

1. Prepare ingredients according to the directions in the pressure cooking recipe you have selected. Recipes in this book were developed for use in a 4-quart pressure cooker. If you have a 6-quart pressure cooker, you may increase the ingredients by $\frac{1}{2}$, if desired. Be sure not to overfill the pressure cooker (see page 5).

Pour liquid into the cooker body, as specified in the recipe or timetable. This liquid is usually water. However, some recipes will call for other liquids, such as wine.

2. Place the cooking rack into the cooker, if called for in the recipe (see Helpful Hints on page 8 for guidance on when to use).
3. **IMPORTANT:** Look through the vent pipe to make certain that it is clear before closing the cover (Fig. C). See safety information on page 5.

Holding the body handle with your left hand and the cover handle with your right hand, align the **V** mark on the cover with the **▲** mark on the body handle and place the cover on the cooker body (Fig. D). Move the cover handle slightly until the cover drops into position.

4. Close the cover securely by rotating it clockwise until the cover handle lines up with the body handle. **The pressure cooker is completely closed when the cover handle is directly above the body handle (Fig. E).**

5. Place the pressure regulator on the vent pipe (Fig. F). The pressure regulator will fit loosely on the vent pipe. It will not touch the top of the pressure cooker cover.

6. Using a high heat setting on your stove, heat the pressure cooker until the pressure regulator attains a gentle rocking motion.

NOTE: The air vent/cover lock may move up and down a few times when cooking first begins as it automatically exhausts air from the pressure cooker. Steam will be noticeable. This is normal. When pressure begins to build, it slides up, locking the cover on. Once the cooker has sealed, the air vent/cover lock will remain in the up position until pressure is released (Fig. G).

7. Cooking time begins when the pressure regulator begins to rock gently. Gradually lower the heat as necessary to maintain a slow, steady rocking motion and cook for the length of time indicated in the recipe or timetable. If the pressure regulator is allowed to rock vigorously, excess steam will escape. Therefore, too much liquid will evaporate and food may scorch. Never leave your pressure cooker unattended at high heat settings. It could boil dry, overheat, and cause damage to the pressure cooker.

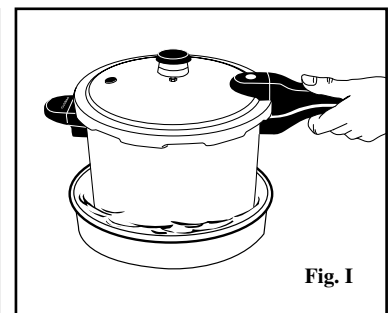
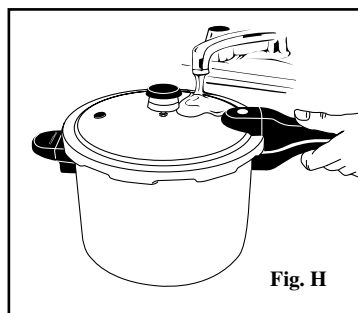
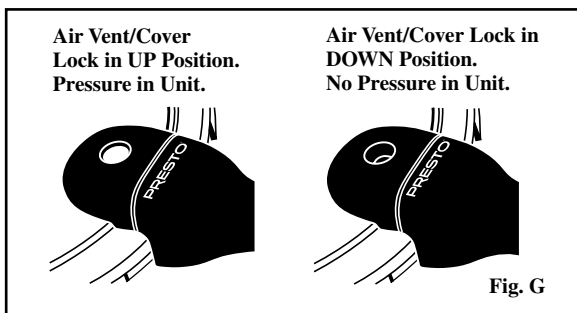
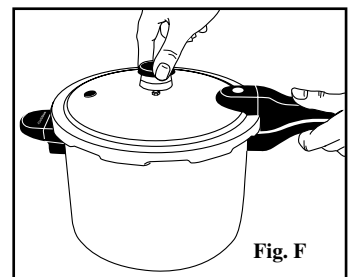
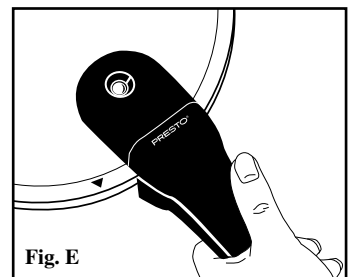
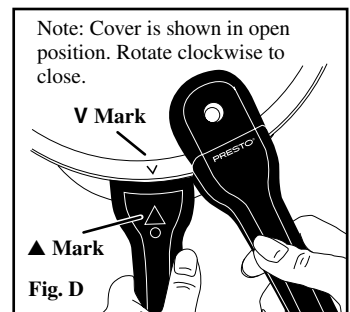
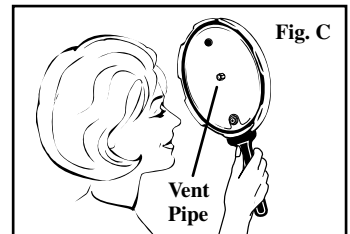

8. When cooking time is complete, turn off burner. If using an electric stove, remove pressure cooker from burner. **Caution: Lift pressure cooker to remove it from the burner. Sliding cookware can leave scratches on stovetops.**
9. Reduce pressure according to the recipe or timetable instructions. If the instructions say “Let the pressure drop of its own accord,” set the pressure cooker aside to cool until pressure is completely reduced. If the instructions state, “Cool cooker at once,” cool the pressure cooker under a running water faucet (Fig. H) or pour cold water over it, or place it in a pan of cold water (Fig. I) until pressure is completely reduced. **Note: Do not set hot cooker in a molded sink as it could damage the sink.**
 Pressure is completely reduced when the air vent/cover lock has dropped.
 If the air vent/cover lock remains in its raised position, there is still pressure inside the pressure cooker. Continue to cool until the air vent/cover lock drops.
10. After pressure has been completely reduced, remove the pressure regulator. **Always remove the pressure regulator before opening the cover.**
11. To open the cover, turn it counterclockwise until the ▼ on the cover aligns with the ▲ mark on the body handle. Then, lift the cover toward you to keep any steam away from you. If the cover turns hard, there still may be some pressure in the unit. **Do not force the cover off.** Continue to cool the pressure cooker until steam no longer is escaping from the vent pipe, the air vent/cover lock has dropped, and the cover turns easily.
12. Food is ready to serve.

IMPORTANT SAFETY INFORMATION

Cooking under pressure enables you to prepare food both quickly and deliciously. If used properly, your pressure cooker is one of the safest appliances in your kitchen. To ensure safe operation, make sure you always observe the following simple rules whenever you use the pressure cooker:

1. **Never overfill the pressure cooker.** — The pressure regulator is designed to maintain cooking pressures at a safe level. It relieves excess pressure through the vent pipe as it rocks back and forth. Many foods tend to expand when cooked. If the cooker is overfilled, expansion of food may cause the vent pipe to become blocked or clogged. If the vent pipe becomes blocked, it cannot relieve excess pressure.

There are a few foods such as rice, grains, dry beans and peas, and soups which expand so much or foam and froth while cooking that the cooker should never be filled above the $\frac{1}{2}$ fill line. For other foods, never fill the cooker above the $\frac{2}{3}$ fill line.

For your convenience, both the $\frac{2}{3}$ and $\frac{1}{2}$ full levels are marked by indentations on the side of the pressure cooker body (see Fig. J). The upper marking indicates the $\frac{2}{3}$ full level and the lower the $\frac{1}{2}$ full level. In addition, in each section of the recipes you will find instructions on the maximum fill level for each type of food.

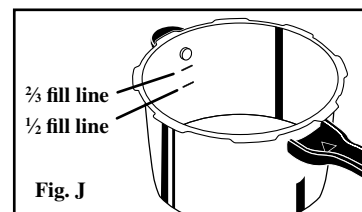

Reminder: When cooking any food, do not let any portion extend above the maximum fill mark. When cooking rice, grains, dry beans and peas, and soups, the cooker should never be more than $\frac{1}{2}$ full.

2. **Always add cooking liquid.** — If an empty pressure cooker is left on a hot burner or if a cooker boils dry and is left on a heated burner, the cooker will overheat excessively causing possible discoloration and/or damage to the cooker.
3. **Always look through the vent pipe before using the cooker to make sure it is clear.** — If the vent pipe is blocked, it cannot function as it should and thus cannot relieve excess pressure. Pressure may then build to unsafe levels. To clean the vent pipe, see page 6.
4. **Always fully close the pressure cooker.** — The cooker is fully closed when the cover handle is directly above the body handle. Your pressure cooker has specially designed lugs on the cover and body which lock the cover in place when the cooker is fully closed. However, if the cooker is not fully closed, the lugs cannot lock the cover onto the body. It's possible that pressure could build inside the cooker and cause the cover to come off and result

in bodily injury or property damage. Always be sure the cover handle is directly above the body handle (see page 4, Fig. E). Do not turn past handle alignment.

5. **Never open the cooker when it contains pressure.** — The air vent/cover lock provides a visual indication of pressure inside the cooker. When it is up, there is pressure. When it is down, there is no pressure in the cooker and it can be opened. If the pressure cooker is opened before all of the pressure is released, the contents of the cooker will erupt and could cause bodily injury or property damage.
6. **Replace the overpressure plug if it is hard, deformed, cracked, worn or pitted, or when replacing the sealing ring. Replace the sealing ring if it becomes hard, deformed, cracked, worn, pitted, or soft and sticky.** — The overpressure plug is a secondary pressure relief valve which is designed to relieve excess pressure by releasing from the cooker cover in the event that the vent pipe becomes blocked. The overpressure plug is made of rubber, and when new, is soft and pliable. Over time, depending on the frequency and type of use, rubber becomes hard and inflexible. When hard and inflexible, the overpressure plug loses its ability to act as a secondary pressure relief valve. It should be replaced immediately.

Should the overpressure plug ever be forced out of the cover due to excess pressure while cooking, it is important to call the Test Kitchen at 1-800-368-2194. **Do not attempt to use the released overpressure plug.**

7. **Always follow special procedures found in the instruction book when pressure cooking rice, grains, and dry beans and peas.** — During cooking, dry beans and peas tend to froth and foam which could cause the vent pipe to become blocked. Therefore, dry beans and peas need to be soaked and cooked according to instructions beginning on page 29. Using this method will keep foam at safe levels during cooking. Like dry beans and peas, rice and grains tend to froth and foam during cooking; therefore, to contain foaming and frothing during the cooking period, rice and grains must be prepared in a bowl in the pressure cooker according to directions on page 31.
8. **Never pressure cook applesauce, cranberries, rhubarb, cereals, pastas, dried soup mixes, or dry beans and peas which are not listed in the chart on page 29.** — These foods expand so much as a result of foaming and frothing that they should never be cooked under pressure.

CARE AND MAINTENANCE

1. All parts of your pressure cooker, including the sealing ring and pressure regulator, are fully immersible for easy cleaning. When washing the unit, however, the sealing ring should always be removed to allow easy cleaning of the inside rim of the cover. The sealing ring should be washed with hot, sudsy water after each use.
2. To be sure the vent pipe is clear, hold the cover up to the light and look through the vent pipe. Clean it with a small brush or pipe cleaner if it is blocked or partially blocked (Fig. K). Also clean the vent pipe nut as shown.

3. Occasionally remove the air vent/cover lock in the pressure cooker cover handle for cleaning. To remove the air vent/cover lock, place your finger over the hole in the cover handle (Fig. M) and remove the white rubber gasket from the air vent/cover lock on the underside of the cover (Fig. L). Push the air vent/cover lock through the top of the cover and wash it and the gasket in hot sudsy water. The metal shaft of the air vent/cover lock may be cleaned with a nylon mesh pad. Clean the hole in the cover handle with a small brush. After cleaning, reinsert the metal shaft of the air vent/cover lock from the top side of the cover down through the cover handle hole (Fig. M). Place a finger over the handle hole (to keep the cover lock from falling out) and turn the cover over. Wet the rubber gasket and push onto the end of the metal shaft until it snaps into the groove on the shaft.

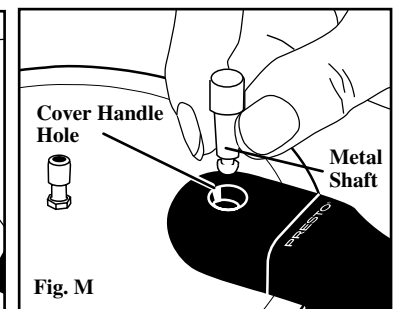
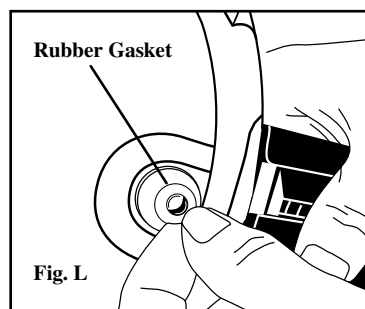
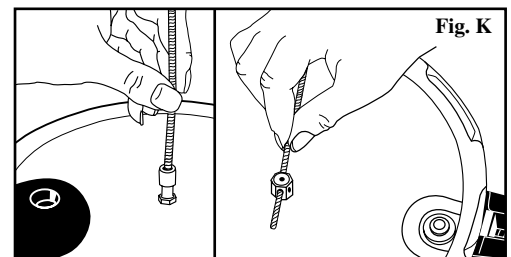

4. The overpressure plug can also be removed for cleaning by pushing it out of its opening from the top of the cover. After cleaning, reinsert it by pushing the domed side of the plug into the opening from the underside of the cover, until the bottom edge is fully and evenly seated against the underside of the cover (Fig. N). When the overpressure plug is properly installed, the word (TOP) will be visible on the overpressure plug when viewing the outside of the cover.

5. Iron and other minerals in water and foods may darken the inside of your aluminum cooker. This discoloration will not affect the food cooked in the unit. These stains can be removed by using a solution of water and cream of tartar. Use a tablespoon of cream of tartar for each quart of water and pour enough solution into the cooker to cover the discoloration (do not fill over $\frac{2}{3}$ full). Close the cover securely, place the pressure regulator on the vent pipe, and heat until the pressure regulator rocks gently. Remove the cooker from the heat and allow it to stand for two to three hours. Remove the pressure regulator and discard the contents. Scour thoroughly with a soap impregnated steel wool pad; wash, rinse, and dry.



The outside surface of aluminum pressure cookers may be cleaned with a good silver polish if necessary. Staining may result if the cooker is washed in the dishwasher. If food residue adheres to the pressure cooker body, clean with a vegetable brush, a fine steel wool pad, or a fine kitchen cleanser.

6. When not in use, store your pressure cooker in a dry place with the cover inverted on the body. If the cover is locked on, unpleasant odors may form inside the unit and the sealing ring could be damaged.
7. As is the case of all cookware, avoid chopping or cutting food inside the cooker with a knife or other sharp utensil.
8. If the body or cover handles become loose, tighten them with a screwdriver.
9. Do not strike the rim of the pressure cooker with any cooking utensil because this could cause nicks in the rim which may allow steam to escape and prevent the pressure cooker from sealing.
10. The sealing ring, overpressure plug, and rubber gasket of the air vent/cover lock may shrink, become hard, deformed, cracked, worn, or pitted with normal use. Exposure to high heat, such as a warm burner or oven top, will cause these parts to deteriorate rapidly. When this happens, replace the sealing ring, overpressure plug, and small rubber gasket of the air vent/cover lock. Replace the sealing ring and overpressure plug at least every two years.

Leakage between the cover and body is usually caused by shrinkage of the sealing ring after prolonged use. Replace the sealing ring. Whenever you replace the sealing ring, replace the overpressure plug also.

11. Each time you clean or use your pressure cooker, check to be sure the bottom has not been damaged. Nicks and scratches may leave sharp edges that can damage ceramic stovetops or other smooth surfaces. Lift pressure cooker to remove it from burner. Sliding cookware could leave scratches on stovetops.
12. The formation of a small amount of moisture under the pressure regulator is normal when cooking first begins. It is the result of the temperature of the regulator being lower than the rest of the unit.

A small amount of steam or moisture may also be visible around the overpressure plug and air vent/cover lock as cooking begins. It should stop when pressure begins to build and the overpressure plug and air vent/cover lock seal. If leakage continues, clean or replace the overpressure plug and/or air vent/cover lock assembly. The pressure cooker will not seal if the gasket for the air vent/cover lock is cracked.

Do not operate your pressure cooker with continual leakage. If the preceding steps do not correct the problem, return the entire unit to the Presto Factory Service Department (see page 37).

13. If for any reason the pressure cooker cannot be opened, contact the Consumer Service Department in Eau Claire, WI at 1-800-877-0441.

Any maintenance required for this product, other than normal household care and cleaning, should be performed by the Presto Factory Service Department (see page 37).

HELPFUL HINTS

- ◆ Your favorite recipes may be adjusted for cooking in the pressure cooker by following the general directions in this book for the particular type of food being cooked. Decrease the cooking time for your recipe by $\frac{2}{3}$ since pressure cooking is much faster than ordinary cooking methods. For example, if your ordinary cooking method requires 45 minutes, in the pressure cooker the cooking time will be 15 minutes. Because there is very little evaporation, the amount of liquid used should be decreased. Use about $\frac{1}{2}$ cup more liquid than you'll desire in your finished dish. But, remember, there must always be water or some other liquid in the pressure cooker to produce the necessary steam.
- ◆ Use the cooking rack when it is desirable to cook foods out of the cooking liquid. When foods are pressure cooked out of the liquid, flavors will not intermingle. Therefore, it is possible to cook several foods at once, as long as they have similar cooking times. If it is desirable to blend flavors, do not use the cooking rack.
- ◆ Many different cooking liquids can be used in a pressure cooker. Wine, beer, bouillon, fruit juices, and of course water all make excellent cooking liquids in the pressure cooker.
- ◆ Beautiful desserts and side dishes can be prepared in the pressure cooker, using individual or small metal molds or glass custard cups, which are ovenproof. Fill molds $\frac{2}{3}$ full to allow for expansion of food, and fit them loosely into the pressure cooker on the cooking rack. Do not fill the pressure cooker over $\frac{2}{3}$ full.
- ◆ If a recipe says to cook 0 minutes, cook food only until the pressure regulator begins to rock. Then cool pressure cooker according to recipe.
- ◆ The pressure cooker is usually cooled at once for delicate foods such as custards and fresh vegetables. For other foods, like meats, soups, and grains, let the pressure drop of its own accord.
- ◆ When pressure cooking at high altitudes, the cooking time needs to be increased 5% for every 1000 feet above the first 2000 feet. Following this rule, the times should be increased as follows:

3000 ft. ... 5%	5000 ft. ... 15%	7000 ft. ... 25%
4000 ft. ... 10%	6000 ft. ... 20%	8000 ft. ... 30%

Because pressure cooking times are increased at altitudes above 2000 feet, an additional $\frac{1}{2}$ cup cooking liquid will be needed.

- ◆ If you have any questions on recipes, time charts, or the operation of your pressure cooker, call or write: Test Kitchen, National Presto Industries, Inc., 3925 North Hastings Way, Eau Claire, Wisconsin 54703-3703, phone 1-800-368-2194. You may also contact us at our website www.GoPresto.com. When writing, please include a phone number and a time when you can be reached during weekdays, if possible. Written inquiries will be answered promptly by letter or telephone.

QUESTIONS & ANSWERS

Occasionally the cover is hard to open or close. What causes this? What should I do?

In order for pressure to build inside your pressure cooker, the unit has a special cover which provides an airtight fit. Because of this, you may find that on occasion the cover may be difficult to open or close. The following suggestions will help if this happens:

If the cover seems hard to close, press the palm of your hand on the cover area directly opposite the cover handle while moving the cover handle to the closed position with your other hand.

If, after browning meat or poultry, the cover is difficult to close, it may be due to expansion of the pressure cooker body from heating. Remove the cover and allow the pressure cooker body to cool slightly and try again. Do not place the pressure cooker back on the burner until it is fully closed.

If necessary, to help make the cover easier to open and close, a very light coating of cooking oil may be applied to the sealing ring and to the underside of the lugs on the pressure cooker body (Fig. O). Use a pastry brush, a piece of cloth, or your fingertips and be sure to wipe off any excess oil.

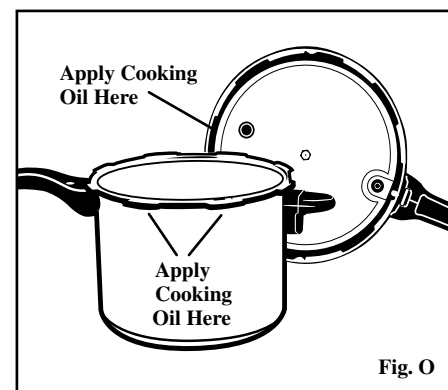

What can be done if the food prepared in the pressure cooker has more liquid than desired?

Simmer to evaporate the excess liquid. Next time you prepare the same recipe, you may want to use less liquid.

How does one prevent overcooking?

Remember to begin timing as soon as the pressure regulator begins to rock gently. It is very important to accurately time the cooking period. A Presto® kitchen timer is very helpful for this purpose. Also be sure to follow the recipe instructions for cooling the pressure cooker.

What if the food is not completely done after the recommended cooking time?

Simply bring the cooker back up to pressure and cook the food a minute or two longer.

Can I use my stainless steel pressure cooker on all types of ranges?

Your pressure cooker will work on gas, electric coil and ceramic glass (smoothtop) ranges. In addition, stainless steel pressure cookers will work on induction ranges.

When cooking first begins, is it normal for steam to escape and moisture to form on the cover and between the handles?

It is normal for steam to escape and a slight amount of moisture leakage to form on the cover and between the handles when cooking first begins. If leakage continues, the cover handle may not be properly aligned with the body handle and, therefore, the cover lock cannot engage.

Is it normal for the air vent/cover lock to rise up partially and drop back down when cooking first begins?

It is possible that the air vent/cover lock will move up and down slightly when cooking first begins. Do not be concerned. The air vent/cover lock will remain in the up position once the cooker has sealed. However, if the air vent/cover lock continues to move up and down or rises partially, tap it lightly with the tip of a knife. If it does not rise once you have tapped it, the following may be occurring:

1. The burner is not hot enough.
2. The cooker is not fully closed (see page 4).
3. There is insufficient liquid to form steam.
4. The gasket for the air vent/cover lock needs to be replaced (see page 6).

SOUPS AND STOCKS

The pressure cooker is perfect for preparing delicious, nourishing soups and stocks in minutes instead of the hours taken by ordinary methods.

Stocks form the base for most great soups and sauces, and you can even substitute a stock for water in many recipes to add extra flavor. Traditionally, stocks are made by simmering bones and scraps for hours to extract all their flavor. With the pressure cooker, you can do the same thing in just minutes by following the simple directions on the following pages.

We've also included a few favorite soup recipes and, if you have a favorite recipe of your own, try it in the pressure cooker using one of the recipes in this book as your guide. If adding dry beans and peas, they must first be soaked according to directions on page 29. **Do not pressure cook soups containing barley, rice, pasta, grains, dry beans and peas which are not listed in the chart on page 29, and dried soup mixes** because they have a tendency to foam, froth, and sputter and could block the vent pipe.

Cooked barley, rice, grains, pasta, dry beans and peas which are not listed in the chart on page 29, and dried soup mixes should be added to the soup after pressure cooking.

*FOR SOUPS AND STOCKS,
DO NOT FILL PRESSURE COOKER OVER ½ FULL!
OPERATING THE COOKER WITHOUT COOKING LIQUID OR
ALLOWING THE COOKER TO BOIL DRY WILL DAMAGE THE COOKER.*

CHICKEN SOUP

1½ pounds chicken, cut into serving pieces	½ cup chopped onion
4 cups water	¼ cup chopped celery
½ cup sliced carrots	1 teaspoon salt
	¼ teaspoon black pepper

Place all ingredients in cooker. Close cover securely. Place pressure regulator on vent pipe and **cook 12 minutes with pressure regulator rocking slowly. Let pressure drop of its own accord.** Remove pieces of chicken from cooker and let cool. Remove meat from bones and return meat to cooker. Heat through.

Nutrition Information Per Serving 4 servings
160 Calories, 8 g Fat, 54 mg Cholesterol

Delicious Soups From Chicken Soup...

CHICKEN SOUP STOCK — Strain Chicken Soup to make stock.

CHICKEN NOODLE SOUP — Bring soup to a boil. Add fine noodles and simmer, uncovered, 10 to 15 minutes. Salt and pepper to taste.

6 servings

CHICKEN DUMPLING SOUP — Mix together 1 beaten egg, ½ cup milk, and ½ teaspoon salt. Stir in 1⅛ cups flour. Drop mixture from teaspoon into bubbling Chicken Soup in cooker. Simmer dumplings uncovered 6 minutes.

6 servings

CHICKEN RICE SOUP — Add 1 cup cooked rice to Chicken Soup. Heat through. Salt and pepper to taste.

6 servings

BROWN BEEF SOUP

1½ pounds lean beef, cut into 1-inch cubes	¼ cup chopped celery
4 cups water	1 bay leaf
½ cup chopped onion	1 teaspoon parsley flakes
½ cup sliced carrots	1 teaspoon salt
	¼ teaspoon black pepper

Place all ingredients in cooker. Close cover securely. Place pressure regulator on vent pipe and **cook 12 minutes with pressure regulator rocking slowly. Let pressure drop of its own accord.**

Nutrition Information Per Serving
295 Calories, 15 g Fat, 110 mg Cholesterol

4 servings

Delicious Soups From Brown Beef Soup...

BROWN BEEF SOUP STOCK — Strain Brown Beef Soup to make stock.

ONION SOUP — Pour 2 tablespoons vegetable oil into cooker and sauté 1½ cups thinly sliced onions. Stir onions into 6 cups Brown Beef Soup Stock in cooker. Season with ¼ teaspoon pepper. Close cover securely. Place pressure regulator on vent pipe and **cook 2 minutes with pressure regulator rocking slowly. Let pressure drop of its own accord.** Ladle into soup bowls. Top with Parmesan cheese. If desired, garnish with croutons or toasted French bread.

6 servings

BEEF TOMATO SOUP — Add 2 cups tomato juice and 1 cup cooked rice to Brown Beef Soup. Heat through.

8 servings

BLACK BEAN SOUP

2 cups dry black beans	4 cups chicken stock or broth
1 tablespoon olive or vegetable oil	2 cups sliced carrots, ¾-inch thick
1 cup chopped onion	1 tablespoon packed brown sugar
3 cloves garlic, minced	2 teaspoons white wine vinegar
1-2 jalapeño chiles, seeded, deveined, minced	•••••
1 tablespoon chili powder	1 cup loosely packed fresh cilantro, chopped
1½ teaspoons oregano	Salt to taste
½ teaspoon allspice	

Soak beans according to instructions on page 29. Pour oil in pressure cooker. Sauté onion, garlic, chiles, chili powder, oregano, and allspice for 2 minutes. Stir in beans, chicken stock, carrots, brown sugar, and vinegar. Close cover securely. Place pressure regulator on vent pipe and **cook 12 minutes with pressure regulator rocking slowly. Let pressure drop of its own accord.** Remove 1 cup of bean mixture, place in blender and purée until smooth. Return to pressure cooker and stir in fresh cilantro.

Nutrition Information Per Serving
231 Calories, 3 g Fat, 0 mg Cholesterol

8 servings

SAFFRON FISH STEW

- | | |
|-----------------------------------|--------------------------------------|
| 1 can (14½ ounces) chicken broth | Pinch of saffron threads |
| ¼ cup dry white wine | or ¼ teaspoon turmeric |
| 4 new red potatoes, quartered | •••••• |
| 3 carrots, cut into ½-inch chunks | 1 pound firm fish (halibut, haddock, |
| 1 medium onion, finely chopped | cod, pollack) fresh or thawed, cut |
| 2 cloves garlic, minced | into 8 pieces |
| ¼ cup chopped parsley | 1 small red pepper, cut into chunks |
| 1 bay leaf | 1 cup frozen peas, thawed |

Place broth, wine, potatoes, carrots, onion, garlic, parsley, bay leaf, and saffron in pressure cooker. Close cover securely. Place pressure regulator on vent pipe and **cook 2 minutes with pressure regulator rocking slowly. Cool cooker at once.** Add fish, pepper, and peas. Close cover securely. Place pressure regulator on vent pipe and **cook 1 minute with pressure regulator rocking slowly. Cool cooker at once.** Discard bay leaf.

Nutrition Information Per Serving
174 Calories, 1 g Fat, 40 mg Cholesterol

8 servings

MINESTRONE

- | | |
|--|--|
| 1 pound lean beef, cut into 1-inch cubes | 1½ teaspoons basil |
| 5 cups water | 1 teaspoon salt |
| 1 can (14-15 ounces) diced tomatoes | 1 bay leaf |
| ½ cup chopped onion | ¼ teaspoon black pepper |
| 1 cup sliced carrots | •••••• |
| ¼ cup chopped celery | 1 can (16 ounces) Great Northern beans |
| 1 clove garlic, minced | 1 can (15 ounces) cut green beans, drained |
| 2 tablespoons parsley flakes | 2 ounces fine noodles |

Place beef, water, tomatoes, onions, carrots, celery, garlic, parsley, basil, salt, bay leaf, and pepper in cooker. Close cover securely. Place pressure regulator on vent pipe and **cook 10 minutes with pressure regulator rocking slowly. Let pressure drop of its own accord.** Add Great Northern beans, green beans, and noodles. Simmer uncovered 10 minutes. Garnish with Parmesan cheese, if desired.

Nutrition Information Per Serving
234 Calories, 6 g Fat, 44 mg Cholesterol

10 servings

POTATO SOUP

- | | |
|-------------------------------|--|
| 1 tablespoon vegetable oil | ¼ teaspoon basil |
| 1 cup finely chopped onions | •••••• |
| ½ cup finely sliced celery | 1 can (12 ounces) evaporated skim milk |
| 3 cups chicken broth | Salt to taste |
| 4 cups peeled, diced potatoes | |
| ¼ teaspoon white pepper | |

Heat oil in pressure cooker over medium heat. Sauté onion and celery until soft. Add broth, potatoes, pepper, and basil to pressure cooker. Close cover securely. Place pressure regulator on vent pipe and **cook 5 minutes with pressure regulator rocking slowly. Let pressure drop of its own accord.** Remove 2 cups of potato mixture; place in blender or food processor and process until smooth. Return to pressure cooker and stir in evaporated milk.

Nutrition Information Per Serving
160 Calories, 2 g Fat, 2 mg Cholesterol

6 servings

ZESTY HOMEMADE CHILI

- | | |
|---------------------------------|---|
| 1½ pounds ground beef | 1 teaspoon ground cumin |
| 1 can (8 ounces) tomato sauce | ½ teaspoon black pepper |
| ½ cup water | ½ teaspoon oregano |
| 1 cup chopped onion | ¼ teaspoon cayenne pepper |
| ¾ cup chopped green pepper | •••••• |
| 2 cloves garlic, finely chopped | 1 can (15 ounces) kidney beans,
drained and rinsed |
| 1 tablespoon chili powder | |
| 1 teaspoon salt | |

Turn heat selector to medium and brown meat. Add remaining ingredients except kidney beans. Close cover securely. Place pressure regulator on vent pipe and **cook 5 minutes with pressure regulator rocking slowly. Let pressure drop of its own accord.** Stir in kidney beans and heat through.

Nutrition Information Per Serving
432 Calories, 17 g Fat, 111 mg Cholesterol

4 servings

SEAFOOD

Seafood is the basis of some of the healthiest and most nutritious meals you can make. It is an excellent source of protein, a good source of minerals, and some vitamins, and it's low in fat and sodium.

Steaming in the pressure cooker brings out the finest, fullest flavors of seafood. The cooking time required is directly related to the thickness of the seafood. To be safe, if the fish you are cooking seems thin for its weight or if it weighs less than the recipe specifies, reduce the cooking time. Overcooking tends to toughen seafood.

*FOR FISH AND SEAFOOD,
DO NOT FILL PRESSURE COOKER OVER ⅔ FULL!
OPERATING THE COOKER WITHOUT COOKING LIQUID OR
ALLOWING THE COOKER TO BOIL DRY WILL DAMAGE THE COOKER.*

SALMON STEAKS MOUTARDE

- | | |
|---|--|
| 4 small salmon steaks, 1-inch thick | 1 cup dry white wine
or chicken broth |
| 4 tablespoons Dijon-style mustard | 1 bay leaf |
| 3-4 sprigs fresh thyme or ½ teaspoon
dried thyme | •••••• |
| 1 tablespoon olive or vegetable oil | 2 tablespoons Dijon-style mustard |
| 1 small onion, chopped | 1 tablespoon cornstarch |
| 1 clove garlic, minced | |

Spread each steak with 1 tablespoon mustard. Press 1 thyme sprig into mustard on each steak or sprinkle with dried thyme. Pour oil into cooker. Turn heat selector to medium and sauté onion and garlic until tender. Stir in wine and bay leaf. Place steaks on rack in cooker. Close cover securely. Place pressure regulator on vent pipe and **cook 2 minutes with pressure regulator rocking slowly. Cool cooker at once.** Carefully remove steaks and rack. Keep steaks warm. Discard bay leaf. Mix 2 tablespoons mustard with cornstarch. Stir into liquid in pressure cooker. Heat until sauce boils and thickens, stirring constantly. Serve sauce with salmon steaks.

Nutrition Information Per Serving
218 Calories, 9 g Fat, 20 mg Cholesterol

4 servings

VARIATION: Substitute halibut for salmon steaks.

“SCAMPI-STYLE” SHRIMP

- | | |
|--|------------------------------|
| 1 pound medium, raw shrimp,
peeled and deveined | ¼ teaspoon salt |
| 3 tablespoons margarine | 1 cup water |
| 2 tablespoons minced green onion | •••••• |
| 6 cloves garlic, minced | 2 tablespoons minced parsley |
| 2 teaspoons lemon juice | ¼ teaspoon grated lemon peel |

Pat shrimp dry with paper towels. Place margarine in cooker. Turn heat selector to medium and melt margarine. Sauté onion and garlic. Stir in lemon juice and salt. Cook until bubbly. Pour into metal bowl which will fit loosely in cooker. Stir in shrimp. Cover bowl firmly with aluminum foil. Pour water into cooker. Place bowl on rack in cooker. Close cover securely. Place pressure regulator on vent pipe and **cook 3 minutes with pressure regulator rocking slowly. Cool cooker at once.** Stir in parsley and lemon peel.

Nutrition Information Per Serving

205 Calories, 11 g Fat, 173 mg Cholesterol

4 servings

SHRIMP JAMBALAYA

- | | |
|---|--|
| 1 cup long grain white rice | 2 cloves garlic, minced |
| 1½ cups water | 1 bay leaf |
| 1 cup water | 1 teaspoon basil |
| •••••• | ½ teaspoon thyme |
| 1 can (14-15 ounces) stewed
tomatoes | ½ teaspoon chili powder |
| ½ cup chicken broth | ¼ teaspoon black pepper |
| ½ pound precooked ham, diced | ¼ teaspoon salt |
| ½ cup chopped onion | ¼ teaspoon hot sauce |
| ½ cup chopped celery | •••••• |
| ½ cup chopped green pepper | 1 pound precooked shrimp, peeled
and deveined |

Combine rice and 1½ cups water in a metal bowl which will fit loosely in cooker. Cover bowl firmly with aluminum foil. Pour 1 cup water into cooker. Place bowl on rack in cooker. Close cover securely. Place pressure regulator on vent pipe and **cook 5 minutes with pressure regulator rocking slowly. Let pressure drop of its own accord.** Open cooker and set rice aside to steam. Remove rack and water.

Add remaining ingredients, except shrimp, to cooker; stir well. Close cover securely. Place pressure regulator on vent pipe and **cook 3 minutes with pressure regulator rocking slowly. Cool cooker at once.** Stir in shrimp; cook uncovered over medium heat until shrimp is heated through, 2 to 3 minutes. Serve over rice.

Nutrition Information Per Serving

252 Calories, 3 g Fat, 157 mg Cholesterol

6 servings

LEMON 'N DILL COD AND BROCCOLI

- | | |
|---|---|
| 1 pound frozen cod fillets,
1-inch thick | Salt |
| Dill weed | 1 cup water |
| lemon pepper | 2 cups broccoli, cut into bite size
pieces |

Cut fish into 4 pieces. Sprinkle with dill weed, lemon pepper, and salt. Pour 1 cup water into cooker. Arrange fish and broccoli on rack in cooker. Close cover securely. Place pressure regulator on vent pipe and **cook 2 minutes with pressure regulator rocking slowly. Cool cooker at once.**

Nutrition Information Per Serving

103 Calories, 1 g Fat, 49 mg Cholesterol

4 servings

SEAFOOD GUMBO

- | | |
|---|---|
| <p>1 cup long grain white rice
 1½ cups water
 1 cup water
 ••••••••</p> <p>2½ cups chicken broth
 1 pound medium, fresh shrimp,
 peeled and deveined
 1 pound sole fillets, cut into
 2-inch pieces
 1 can (14-15 ounces) diced
 tomatoes
 1 cup chopped onion
 ¾ cup chopped green pepper</p> | <p>2 cloves garlic, minced
 2 bay leaves
 2 tablespoons parsley
 1 teaspoon basil
 ½ teaspoon thyme
 ¼ teaspoon ground red pepper
 ¼ teaspoon salt
 ••••••••</p> <p>¼ cup cold water
 2 tablespoons cornstarch
 1 package (10 ounces) frozen
 sliced okra, thawed</p> |
|---|---|

Combine rice and 1½ cups water in a metal bowl which will fit loosely in cooker. Cover bowl firmly with aluminum foil. Pour 1 cup water into cooker. Place bowl on rack in cooker. Close cover securely. Place pressure regulator on vent pipe and **cook 5 minutes with pressure regulator rocking slowly. Let pressure drop of its own accord.** Open cooker and set rice aside to steam. Remove rack and water.

Add broth, shrimp, sole, tomatoes, onion, green pepper, garlic, bay leaves, parsley, basil, thyme, red pepper, and salt to cooker. Close cover securely. Place pressure regulator on vent pipe and **cook 1 minute with pressure regulator rocking slowly. Cool cooker at once.** Combine water and cornstarch. Stir into hot mixture. Heat until sauce thickens, stirring constantly. Stir in okra. Heat for 3 to 4 minutes. Discard bay leaf. Serve over rice.

Nutrition Information Per Serving *9 servings*
 224 Calories, 2 g Fat, 101 mg Cholesterol

MARINATED TUNA

- | | |
|---|---|
| <p>1 pound tuna steak, 1-inch thick
 ¼ cup lemon juice
 2 tablespoons olive oil
 1 tablespoon soy sauce</p> | <p>2 cloves garlic, minced
 1 teaspoon ginger
 ½ teaspoon black pepper
 ½ cup water</p> |
|---|---|

Place tuna steaks in a shallow glass dish. Combine remaining ingredients except water; pour over tuna. Marinate for 30 minutes, turning fish once. Remove tuna from marinade and place tuna on rack in cooker. Pour marinade and water into cooker. Place pressure regulator on vent pipe and **cook 2 minutes with pressure regulator rocking slowly. Cool cooker at once.**

Nutrition Information Per Serving *4 servings*
 170 Calories, 6 g Fat, 52 mg Cholesterol

SEAFOOD TIMETABLE

Pour 1 cup water into cooker. Position rack in cooker. Place seafood on rack in cooker. Do not fill cooker over ⅔ full. Close cover securely. Place pressure regulator on vent pipe and **cook according to chart. Cool cooker at once.**

SEAFOOD (FRESH OR THAWED)	COOKING TIME	SEAFOOD (FRESH OR THAWED)	COOKING TIME
Crab Legs	0 to 1 minute	Shrimp	
Fish Fillets (1-inch thick)	2 minutes	Medium to Large (36 to 40 count)	0 to 1 minute
Salmon Fillets (1-inch thick)	2 minutes	Large (21 to 25 count)	1 minute
Scallops (Large)	1 minute	Tuna Fillets (1-inch thick)	2 minutes

POULTRY

A host of great, light meals can evolve from chicken and other poultry when prepared in the pressure cooker. Be it a tender fillet with a delightful, light sauce or a savory casserole with a host of nutritious vegetables, you'll find the pressure cooker is perfect for preparing your favorites in a hurry.

Try the following recipes and enjoy tasty poultry in a variety of ways or prepare your own favorite poultry dishes. It's not necessary to brown poultry before pressure cooking, but you may do so if you like. Searing tends to seal in the natural juices, while cooking without browning lets the flavor of the various ingredients intermingle for some spectacular taste combinations. For crispier chicken, you may want to put the chicken under the broiler for a few minutes after pressure cooking.

*FOR POULTRY, DO NOT FILL PRESSURE COOKER OVER $\frac{2}{3}$ FULL!
NO PORTION OF THE POULTRY SHOULD EXTEND ABOVE
THE $\frac{2}{3}$ FULL MARK (SEE PAGE 5).*

*OPERATING THE COOKER WITHOUT COOKING LIQUID OR
ALLOWING THE COOKER TO BOIL DRY WILL DAMAGE THE COOKER.*

CHICKEN BREASTS TARRAGON

- | | | | |
|---------------|--|---------------|-----------------------|
| 1 | tablespoon vegetable oil | $\frac{1}{4}$ | cup sliced carrot |
| 4 | boneless, skinless chicken breast halves | 1 | teaspoon tarragon |
| | | 1 | teaspoon salt |
| $\frac{1}{2}$ | cup white wine | $\frac{1}{4}$ | teaspoon black pepper |
| | Worcestershire sauce | ••••• | |
| $\frac{1}{2}$ | cup white wine | $\frac{1}{4}$ | cup water |
| $\frac{1}{4}$ | cup chopped onion | 1 | tablespoon cornstarch |
| $\frac{1}{4}$ | cup sliced celery | | |

Pour oil into cooker. Turn heat selector to medium and brown chicken. Add remaining ingredients except cornstarch and water. Close cover securely. Place pressure regulator on vent pipe and **cook 4 minutes with pressure regulator rocking slowly. Cool cooker at once.** Remove chicken and keep warm. Combine water and cornstarch. Stir into sauce. Heat until sauce thickens, stirring constantly.

Nutrition Information Per Serving
219 Calories, 5 g Fat, 69 mg Cholesterol

4 servings

CALIFORNIA CHICKEN

- | | | | |
|---------------|--|---------------|--------------------------|
| 2 | tablespoons vegetable oil | $\frac{1}{2}$ | cup chicken broth |
| 6 | boneless, skinless chicken breast halves | $\frac{1}{4}$ | cup chopped parsley |
| | | ••••• | |
| 1 | teaspoon rosemary | $\frac{1}{2}$ | lemon, thinly sliced |
| 3 | cloves garlic, peeled and sliced | | Salt and pepper to taste |
| $\frac{1}{2}$ | cup white wine | | |

Pour oil into cooker. Turn heat selector to medium and brown chicken. Season chicken with rosemary. Place chicken in cooker. Cover chicken with garlic. Combine wine, broth, and parsley; pour over chicken. Close cover securely. Place pressure regulator on vent pipe and **cook 4 minutes with pressure regulator rocking slowly. Cool cooker at once.** Garnish chicken with lemon slices.

Nutrition Information Per Serving
191 Calories, 6 g Fat, 69 mg Cholesterol

6 servings

CHUTNEY CHICKEN

6 boneless, skinless chicken breast halves	1/3 cup mango chutney
1 can (14-15 ounces) diced tomatoes	1 tablespoon vinegar
1 can (4 ounces) chopped green chilies	1 tablespoon brown sugar
1/2 cup raisins	1/4 teaspoon allspice
	•••••
	1/4 cup water
	1 tablespoon cornstarch

Place all ingredients except cornstarch and water in cooker. Close cover securely. Place pressure regulator on vent pipe and **cook 4 minutes with pressure regulator rocking slowly. Let pressure drop of its own accord.** Remove chicken and keep warm. Combine water and cornstarch. Stir into sauce. Heat until sauce thickens, stirring constantly.

Nutrition Information Per Serving
258 Calories, 3 g Fat, 73 mg Cholesterol

6 servings

SOY CHICKEN

4 boneless, skinless chicken breast halves	1/2 cup sliced mushrooms
1/2 cup water	1/2 onion, sliced
1/4 cup low sodium soy sauce	1/2 cup sliced celery
	3 tablespoons brown sugar

Place all ingredients in cooker. Close cover securely. Place pressure regulator on vent pipe and **cook 4 minutes with pressure regulator rocking slowly. Let pressure drop of its own accord.**

Nutrition Information Per Serving
169 Calories, 2 g Fat, 69 mg Cholesterol

4 servings

SWEET 'N SOUR CHICKEN

3 pound chicken, cut into serving pieces and skinned	1/2 cup vinegar
1 tablespoon vegetable oil	2 tablespoons soy sauce
1 can (8 ounces) pineapple chunks, undrained	1 tablespoon catsup
1/2 cup sliced celery	1/2 teaspoon Worcestershire sauce
1 green or red pepper, cut into chunks	1/4 teaspoon ground ginger
1/4 cup brown sugar	•••••
	2 tablespoons cold water
	2 tablespoons cornstarch

Pour oil into cooker. Turn heat selector to medium and brown chicken. Combine remaining ingredients except water and cornstarch; pour over chicken. Close cover securely. Place pressure regulator on vent pipe and **cook 8 minutes with pressure regulator rocking slowly. Cool cooker at once.** Remove chicken, pineapple, and vegetables to a warm platter. Mix cold water and cornstarch. Stir into hot liquid. Heat until sauce thickens, stirring constantly. Pour sauce over chicken, pineapple, and vegetables. Serve with steamed rice, if desired, see page 31.

Nutrition Information Per Serving
333 Calories, 11 g Fat, 104 mg Cholesterol

6 servings

CHICKEN CACCIATORE

- | | |
|--|-------------------------------------|
| 3 pound chicken, cut into serving pieces | 2 cloves garlic, minced |
| 1 cup diced tomatoes | 2 tablespoons minced parsley |
| $\frac{1}{3}$ cup white wine | 1 teaspoon oregano |
| 1½ cups sliced onions | 1 teaspoon salt |
| $\frac{1}{2}$ cup chopped carrots | $\frac{1}{4}$ teaspoon black pepper |
| $\frac{1}{2}$ cup chopped celery | •••••• |
| | 1 can (6 ounces) tomato paste |

Place all ingredients except tomato paste in pressure cooker. Close cover securely. Place pressure regulator on vent pipe and **cook 8 minutes with pressure regulator rocking slowly. Cool cooker at once.** Place chicken on warm platter. Stir tomato paste into sauce in cooker. Simmer until thickened. Pour over chicken.

Nutrition Information Per Serving

6 servings

291 Calories, 14 g Fat, 90 mg Cholesterol

HERBED CHICKEN

- | | |
|---|--------------------------------------|
| 1 tablespoon vegetable oil | 1 teaspoon oregano |
| 1 cup chopped onion | 1 teaspoon basil |
| 1 tablespoon chopped garlic | •••••• |
| 3 pounds chicken thighs, skinned | 1 can (4 ounces) sliced black olives |
| 1 cup chicken broth | 2 tablespoons cold water |
| 1 tablespoon chopped parsley | 2 tablespoons flour |
| $\frac{1}{2}$ cup chopped celery leaves | Salt and pepper to taste |

Pour oil into cooker. Turn heat selector to medium and sauté onion and garlic; remove. Brown chicken. Add onion, garlic, broth, parsley, celery leaves, oregano, and basil. Close cover securely. Place pressure regulator on vent pipe and **cook 8 minutes with pressure regulator rocking slowly. Cool cooker at once.** Remove chicken to a warm dish. Add olives to liquid and heat. Mix cold water with flour. Stir into hot broth. Heat until sauce thickens, stirring constantly. Pour sauce over chicken.

Nutrition Information Per Serving

6 servings

250 Calories, 8 g Fat, 115 mg Cholesterol

CHICKEN AND DRESSING

- | | |
|---|----------------------------------|
| 2½ cups cooked chicken, cut into bite size pieces | $\frac{1}{4}$ cup chopped celery |
| 1 can (10½ ounces) cream of chicken soup | $\frac{1}{4}$ cup chopped onion |
| 1½ cups seasoned bread crumbs | 2 chicken bouillon cubes |
| | 2 cups hot water |
| | 1½ cups water |

Place chicken in greased metal bowl which will fit loosely in the cooker. Cover chicken with chicken soup. Combine stuffing, celery, onion; moisten with bouillon cubes dissolved in hot water. Spread over chicken soup. Cover bowl firmly with aluminum foil. Pour 1½ cups water into cooker. Place bowl on rack in cooker. Close cover securely. Place pressure regulator on vent pipe and **cook 5 minutes with pressure regulator rocking slowly. Let pressure drop of its own accord.**

Nutrition Information Per Serving

6 servings

317 Calories, 13 g Fat, 109 mg Cholesterol

TURKEY BREAST*

*NOTE: USE THIS RECIPE ONLY IN A 6-QUART PRESSURE COOKER

- | | |
|---|---|
| <p>3-4 pound turkey breast
 1 tablespoon vegetable oil
 1½ cups water
 1 onion, chopped</p> | <p>½ cup chopped celery
 ½ teaspoon poultry seasoning
 Salt and pepper to taste</p> |
|---|---|

Pour oil into cooker. Turn heat selector to medium and brown turkey on all sides. Add remaining ingredients. Close cover securely. Place pressure regulator on vent pipe and **cook 35 minutes with pressure regulator rocking slowly. Let pressure drop of its own accord.** Thicken gravy, if desired.

Nutrition Information Per Serving 6 to 8 servings
 197 Calories, 8 g Fat, 76 mg Cholesterol

BAYOU BOUNTY CHICKEN

- | | |
|--|--|
| <p>1½ pounds chicken pieces
 1 can (15 ounces) whole tomatoes, undrained, cut up
 ¾ cup chopped onion
 ⅓ cup chopped green pepper
 ⅓ cup chopped celery</p> | <p>2 cloves garlic, minced
 ½ tablespoon extra-spicy seasoning blend
 •••••
 Hot cooked rice (see page 31)</p> |
|--|--|

Add all ingredients except rice to pressure cooker. Close cover securely. Place pressure regulator on vent pipe and **cook 8 minutes with pressure regulator rocking slowly. Let pressure drop of its own accord.** Serve chicken and sauce over rice.

Nutrition Information Per Serving 3 servings
 394 Calories, 14 g Fat, 90 mg Cholesterol

POULTRY TIMETABLE

It is not necessary to brown poultry before pressure cooking, but you may do so if you like. After browning remove poultry from cooker and pour liquid into cooker. Place poultry on rack in cooker.

*DO NOT FILL PRESSURE COOKER OVER ⅔ FULL!
 NO PORTION OF THE POULTRY SHOULD EXTEND
 ABOVE THE ⅔ FULL MARK (SEE PAGE 5).*

POULTRY	CUPS OF LIQUID	COOKING TIME (MINUTES)
Whole Chicken (2½ to 3 pounds)	1	13 to 15
Chicken (cut into serving pieces)	1	8
Chicken Breast (boneless)	1	3 to 4*
Turkey Breast** (3 to 4 pounds)	1½	35

*Cool cooker at once (see page 4).

**NOTE: COOK ONLY IN A 6-QUART PRESSURE COOKER.

MEATS

When it comes to creating juicy, tender, flavorful meat dishes, the pressure cooker has no equal. Even budget cuts of meat that usually require slow, moist-heat cooking will turn out succulent and savory—in very little time in the pressure cooker.

An important step when preparing meat in the pressure cooker is to sear meat to a crispy brown on all sides to seal in natural juices. This can be done right in the pressure cooker. The following recipes were written for fresh or completely thawed meats. To cook frozen meats, thaw one half hour or more so that the surface of the meat will sear crispy brown. Then increase the cooking times given in the recipes. Frozen beef, veal, and lamb should be cooked 25 minutes per pound. Frozen pork should be cooked 30 minutes per pound.

Cooking time will vary depending on the size and thickness of the cut, the distribution of fat and bone, the grade and cut of the meat, and the degree of doneness desired.

After cooking, if gravy is desired, stir 1 to 2 tablespoons of flour or cornstarch into $\frac{1}{4}$ cup cold water. Heat cooking liquid in pressure cooker and slowly pour in flour mixture, stirring to blend. Heat to boiling, stirring constantly for 1 minute or until thickened. Season with salt and pepper.

*FOR MEAT, DO NOT FILL PRESSURE COOKER
OVER $\frac{2}{3}$ FULL! NO PORTION OF THE MEAT SHOULD
EXTEND ABOVE THE $\frac{2}{3}$ FULL MARK (SEE PAGE 5).*

*OPERATING THE COOKER WITHOUT COOKING LIQUID OR
ALLOWING THE COOKER TO BOIL DRY WILL DAMAGE THE COOKER.*

BEEF POT ROAST

3 pounds beef pot roast	Salt and pepper
1 tablespoon vegetable oil	1 small onion, chopped
2 cups water	1 bay leaf

Pour oil into cooker. Turn heat selector to medium and brown roast well on all sides; remove roast. Pour water into cooker. Place roast on rack in cooker. Season roast with salt, pepper, onions, and bay leaf. Close cover securely. Place pressure regulator on vent pipe and **cook 45 minutes with pressure regulator rocking slowly. Let pressure drop of its own accord.** Thicken gravy, if desired.

Nutrition Information Per Serving
297 Calories, 20 g Fat, 72 mg Cholesterol

6 servings

PORCUPINE MEATBALLS

1 pound lean ground beef	$\frac{1}{4}$ cup sliced celery
$\frac{1}{3}$ cup uncooked long-grain white rice	$\frac{1}{4}$ cup chopped green pepper
2 tablespoons tomato paste	1 cup tomato sauce
1 teaspoon salt	$\frac{1}{2}$ cup water
$\frac{1}{4}$ teaspoon pepper	1 tablespoon sugar
$\frac{1}{2}$ cup chopped onion	$\frac{1}{2}$ teaspoon dry mustard

Combine ground beef, rice, tomato paste, salt, and pepper; mix well. Form into 8 balls. Place meatballs in cooker. Add onion, celery, and green pepper. Combine tomato sauce, water, sugar, and mustard. Pour over meatballs. Close cover securely. Place pressure regulator on vent pipe and **cook 12 minutes with pressure regulator rocking slowly. Cool cooker at once.**

Nutrition Information Per Serving
350 Calories, 17 g Fat, 77 mg Cholesterol

4 servings

SWISS STEAK

2 pounds round steak, 1-inch thick	½ cup chopped green pepper
1 can (8 ounces) tomato sauce	½ cup sliced celery
½ cup water	½ teaspoon salt
1 cup chopped onion	¼ teaspoon pepper

Place all ingredients in cooker. Close cover securely. Place pressure regulator on vent pipe and **cook 18 minutes with pressure regulator rocking slowly. Cool cooker at once.** Thicken sauce, if desired.

Nutrition Information Per Serving

6 servings

251 Calories, 9 g Fat, 98 mg Cholesterol

BEEF STEW

1 pound lean beef, cut into 1-inch cubes	1 cup sliced carrots
1 cup water	1 cup diced tomatoes
1 large onion, sliced	1 teaspoon salt
••••••••	¼ teaspoon black pepper
4 small potatoes, quartered	¼ cup cold water
1 cup frozen green beans	1 tablespoon flour

Place beef, water, and onion in cooker. Close cover securely. Place pressure regulator on vent pipe and **cook 8 minutes with pressure regulator rocking slowly. Cool cooker at once.** Add potatoes, green beans, carrots, tomatoes, salt, and pepper to cooker. Close cover securely. Place pressure regulator on vent pipe and **cook 3 minutes with pressure regulator rocking slowly. Cool cooker at once.**

Mix water and flour; stir into stew. Heat until stew thickens, stirring constantly.

Nutrition Information Per Serving

4 servings

347 Calories, 7 g Fat, 73 mg Cholesterol

SPAGHETTI MEAT SAUCE

1 pound lean ground beef	1 teaspoon salt
1 can (14 to 15 ounces) diced tomatoes	1 teaspoon parsley flakes
½ cup water	½ teaspoon oregano
1 cup chopped onion	½ teaspoon basil
½ cup chopped celery	¼ teaspoon thyme
½ cup diced green pepper	⅛ teaspoon red pepper
1 clove garlic, minced	3 drops hot pepper sauce
2 teaspoons sugar	••••••••
	1 can (6 ounces) tomato paste

Turn heat selector to medium and brown beef. Stir in remaining ingredients except tomato paste. Close cover securely. Place pressure regulator on vent pipe and **cook 8 minutes with pressure regulator rocking slowly. Cool cooker at once.** Stir in tomato paste and simmer, uncovered, to desired thickness. Serve sauce over spaghetti. Sprinkle with Parmesan cheese, if desired.

Nutrition Information Per Serving

6 servings

229 Calories, 12 g Fat, 51 mg Cholesterol

APRICOT BARBECUE PORK ROAST

3 pound boneless rolled pork roast	1 teaspoon crushed red pepper
$\frac{1}{2}$ cup catsup	1 teaspoon dry mustard
$\frac{1}{2}$ cup teriyaki sauce	$\frac{1}{4}$ teaspoon black pepper
$\frac{1}{3}$ cup apricot preserves	1 large onion, sliced
$\frac{1}{4}$ cup cider vinegar	2 cups water
$\frac{1}{4}$ cup packed dark brown sugar	

Place pork roast in a large plastic bag or glass dish. Combine catsup, teriyaki sauce, preserves, vinegar, brown sugar, red pepper, mustard, and pepper. Mix thoroughly and pour over pork. Refrigerate overnight. Remove pork; reserve marinade. Brown pork on all sides in pressure cooker over medium heat; remove.

Place cooking rack, half of sliced onion, and water in cooker. Place pork roast on rack in cooker and arrange remaining onion evenly on top of roast. Close cover securely. Place pressure regulator on vent pipe and **cook 60 minutes with pressure regulator rocking slowly. Let pressure drop of its own accord.** Place reserved marinade in saucepan and simmer until thickened, stirring occasionally. Remove roast and onions from pressure cooker. Add onions to thickened marinade and serve with sliced pork. Onions may be puréed before adding to sauce and served with rice, if desired.

Nutrition Information Per Serving

332 Calories, 13 g Fat, 77 mg Cholesterol

8 servings

BARBECUE SPARERIBS

3 pounds spareribs, cut into serving pieces	$\frac{1}{2}$ cup vinegar
1 cup water	$\frac{1}{4}$ cup chopped onion
••••••••	$\frac{1}{4}$ cup sugar
1 cup catsup	1 teaspoon salt
$\frac{1}{2}$ cup water	1 teaspoon chili powder
	1 teaspoon celery seed

Place ribs and water in cooker. Close cover securely. Place pressure regulator on vent pipe and **cook 5 minutes with pressure regulator rocking slowly. Cool cooker at once.** Drain off liquid. Mix remaining ingredients; pour over ribs in cooker. Stir to coat ribs. Close cover securely. Place pressure regulator on vent pipe and **cook 10 minutes with pressure regulator rocking slowly. Let pressure drop of its own accord.** Remove ribs. Simmer sauce, uncovered, to desired thickness.

Nutrition Information Per Serving

427 Calories, 27 g Fat, 107 mg Cholesterol

6 servings

CORNERED BEEF

3 pounds corned beef	1 tablespoon garlic powder
2 cups water	1 bay leaf

Pour 2 cups water into cooker. Rub garlic powder into all surfaces of corned beef. Place corned beef on rack in cooker. Add bay leaf. Close cover securely. Place pressure regulator on vent pipe and **cook 60 minutes with pressure regulator rocking slowly. Let pressure drop of its own accord.**

Note: If seasoning packet is provided with corn beef, use packet and omit bay leaf.

Nutrition Information Per Serving

295 Calories, 18 g Fat, 103 mg Cholesterol

6 servings

STUFFED PORK CHOPS

2 tablespoons vegetable oil	1 cup bran flakes, crushed
4 1-inch thick boneless pork chops, with deep pocket cut in each	2 tablespoons water
1 cup chopped onion	½ teaspoon dried sage
¾ cup chopped celery	1½ cups water
½ cup corn	Salt and pepper to taste

Pour oil into cooker. Turn heat selector to medium and brown pork chops. Remove from cooker. Sauté onions and celery in cooker. Stir in corn, bran flakes, 2 tablespoons water, and sage; remove from cooker. Stuff pork chops with mixture. Pour 1½ cups water into cooker. Place pork chops on rack in cooker. Close cover securely. Place pressure regulator on vent pipe and **cook 16 minutes with pressure regulator rocking slowly. Cool cooker at once.**

Nutrition Information Per Serving

4 servings

430 Calories, 20 g Fat, 133 mg Cholesterol

PORK LOIN ROAST

3 pound pork loin roast	Salt and pepper
1 tablespoon vegetable oil	1 onion, sliced
2 cups water	

Pour vegetable oil into cooker. Turn heat selector to medium and brown roast well on all sides. Remove roast from cooker. Pour water into cooker. Place roast on rack in cooker. Season with salt, pepper, and sliced onion. Close cover securely. Place pressure regulator on vent pipe and **cook 55 minutes with pressure regulator rocking slowly. Let pressure drop of its own accord.**

Nutrition Information Per Serving

6 servings

483 Calories, 27 g Fat, 171 mg Cholesterol

STUFFED FLANK STEAK

1 tablespoon margarine	¼ teaspoon marjoram
½ cup chopped onion	¼ teaspoon thyme
½ cup chopped celery	⅛ teaspoon black pepper
1 clove garlic, minced	1 pound flank steak, cut into 2 equal pieces
6 tablespoons beef broth, divided	1 cup diced tomatoes
1 cup bread crumbs	
½ teaspoon salt	

Add margarine to cooker. Turn heat selector to medium and sauté onion, celery, and garlic. Mix in 2 tablespoons of the broth, bread crumbs, salt, marjoram, thyme, and pepper. Spread stuffing mixture on one steak; top with remaining steak. Secure with toothpicks or metal skewers. Place steak in cooker; stir in remaining 4 tablespoons broth and tomatoes. Close cover securely. Place pressure regulator on vent pipe and **cook 18 minutes with pressure regulator rocking slowly. Let pressure drop of its own accord.**

Nutrition Information Per Serving

4 servings

237 Calories, 12 g Fat, 47 mg Cholesterol

LAMB STEW

<p>1 pound lamb stew meat, cut into 1-inch cubes</p> <p>1 cup water</p> <p>1 large onion, sliced</p> <p>1 tablespoon Worcestershire sauce</p> <p>1 large clove garlic, minced</p>	<p>4 small potatoes, quartered</p> <p>1 cup baby-cut carrots</p> <p>1 teaspoon salt</p> <p>¼ teaspoon black pepper</p> <p>¼ cup cold water</p> <p>1 tablespoon flour</p>
---	--

Place lamb, water, onion, Worcestershire sauce, and garlic in cooker. Close cover securely. Place pressure regulator on vent pipe and **cook 6 minutes with pressure regulator rocking slowly. Cool cooker at once.**

Add potatoes, carrots, salt, and pepper. Close cover securely. Place pressure regulator on vent pipe and **cook 3 minutes with pressure regulator rocking slowly. Cool cooker at once.**

Mix water and flour thoroughly; stir into stew. Heat until stew thickens, stirring constantly.

Nutrition Information Per Serving

4 servings

315 Calories, 6 g Fat, 74 mg Cholesterol

MEAT TIMETABLE

Brown meat well and remove from cooker. Pour liquid into cooker. Place meat on rack in cooker.

*DO NOT FILL PRESSURE COOKER OVER ⅔ FULL!
NO PORTION OF THE MEAT SHOULD EXTEND ABOVE THE
⅔ FULL MARK (SEE PAGE 5).*

MEAT			CUPS OF LIQUID	COOKING TIME (MINUTES)
BEEF	Chuck Roast	3 pounds	2	45 – 50
	Corned Beef	3 pounds	2	60
	Rolled Rib Roast	3 pounds	1½	30 – 35
	Round Steak	1" thick	1	18*
	Round Steak	½" thick	1	10*
	Short Ribs		1½	25
HAM	Slice	3 pounds	1½	30 – 35
	Picnic	3 pounds	1½	30 – 35
LAMB	Chops	1" thick	1	12*
	Chops	½" thick	1	5*
	Leg of Lamb	3 pounds	2	35-45
PORK	Chops	1" thick	1	15*
	Chops	½" thick	1	8*
	Butt Roast	3 pounds	2	55
	Loin Roast	3 pounds	2	55
	Steak	1" thick	1	12*
	Steak	½" thick	1	5*
VEAL	Chops	1" thick	1	12*
	Chops	½" thick	1	5*
	Roast	3 pounds	2	45 – 50
	Steak	1" thick	1	10*

*Cool cooker at once (see page 4).

VEGETABLES

Vegetables have assumed new importance and prominence on the menu. Health-conscious cooks feature an abundance of vegetables on the family meal plan, while restaurants increasingly cater to a more “vegetable-conscious” clientele.

Pressure cooking is the preferred method for preparing vegetables. Because of the fast cooking time and super-heated steam, vegetables retain most of their natural color, texture, flavor, and nutrients. And pressure cooking offers an additional health advantage, because so much more natural taste is retained, vegetables require much less salt and seasonings.

A garden variety of fresh or frozen vegetables can be cooked at the same time in the pressure cooker. By using the cooking rack to keep them out of the cooking liquid, each vegetable retains its own distinctive flavor and appearance. Just be sure that all vegetables cooked together require the same cooking time. It is important to accurately time the cooking period, because vegetables cook very quickly in the pressure cooker. If you wish to blend the vegetable flavors, place them in the cooking liquid and omit the rack.

*FOR FRESH AND FROZEN VEGETABLES,
DO NOT FILL PRESSURE COOKER OVER 2/3 FULL!
OPERATING THE COOKER WITHOUT COOKING LIQUID OR
ALLOWING THE COOKER TO BOIL DRY WILL DAMAGE THE COOKER.*

CABBAGE WITH APPLES

8 cups shredded cabbage	1/2 cup chicken broth
1 small onion, thinly sliced	2 tablespoons frozen apple juice concentrate, thawed
1 small tart apple, peeled, cored, and chopped	Salt and pepper to taste

Add all ingredients to cooker. Close cover securely. Place pressure regulator on vent pipe and **cook 4 minutes with pressure regulator rocking slowly. Cool cooker at once.**

Nutrition Information Per Serving
50 Calories, 0 g Fat, 0 mg Cholesterol

6 servings

GLAZED ROOT VEGETABLES

2 tablespoons margarine	2 tablespoons sugar
2 medium turnips, peeled, cut into eighths	2 teaspoons ground ginger
8 ounces baby carrots	••••••
2 medium parsnips, peeled, sliced 1/2-inch thick	1/4 cup cold water, optional
1 cup chicken broth	1 tablespoon cornstarch, optional
	Salt and pepper to taste

Heat margarine in pressure cooker over medium heat; add turnip wedges and carrots and sauté for 3 minutes. Add parsnips, chicken broth, ginger, and sugar. Close cover securely. Place pressure regulator on vent pipe and **cook 1 minute with pressure regulator rocking slowly. Cool cooker at once.** Combine water and cornstarch. Stir into sauce. Heat until sauce thickens, stirring constantly.

Nutrition Information Per Serving
77 Calories, 3 g Fat, 0 mg Cholesterol

8 servings

GARLIC MASHED POTATOES

- | | |
|---|---------------------------------|
| 2 pounds russet potatoes, peeled
and diced | •••••• |
| 4 large cloves garlic | 1 tablespoon margarine |
| 1½ cups chicken broth | Salt and pepper to taste |

Place all ingredients except margarine and salt and pepper in cooker. Close cover securely. Place pressure regulator on vent pipe and **cook 5 minutes with pressure regulator rocking slowly. Cool cooker at once.** Allow potatoes, garlic, and broth to remain in cooker. Mash potatoes using a potato masher or hand mixer until desired consistency is reached. Add margarine.

Nutrition Information Per Serving *6 servings*
127 Calories, 4 g Fat, 0 mg Cholesterol

ARTICHOKES 'N SAUCE

- | | |
|-----------------------------------|---------------------|
| 1 cup water | 3 artichokes |
| 1 tablespoon vegetable oil | |

Pour water and oil into cooker. Place artichokes on rack in cooker. Close cover securely. Place pressure regulator on vent pipe and **cook 10 minutes with pressure regulator rocking slowly. Cool cooker at once.** Serve with your choice of the following sauces.

Nutrition Information Per Serving *3 servings*
60 Calories, 0 g Fat, 0 mg Cholesterol

GARLIC SAUCE — Combine ¼ cup margarine, melted and 2 cloves minced garlic. Serve warm.

HERB YOGURT — Combine 1 cup plain yogurt, ¼ cup finely chopped carrots, ½ teaspoon dill weed, and ¼ teaspoon salt. Serve chilled.

ITALIAN SAUCE — Combine ½ cup mayonnaise and ¼ cup Italian style salad dressing. Serve chilled.

MAPLE GLAZED SWEET POTATOES

- | | |
|---|--------------------------------------|
| 3 sweet potatoes, peeled, cut into
1 to 1½-inch chunks | ½ cup water |
| ¾ cup maple flavored syrup | 1 tablespoon melted margarine |
| | ½ teaspoon salt |

Place sweet potatoes in pressure cooker. Combine remaining ingredients and pour over potatoes. Close cover securely. Place pressure regulator on vent pipe and **cook 5 minutes with pressure regulator rocking slowly. Cool cooker at once.**

Nutrition Information Per Serving *6 servings*
125 Calories, 2 g Fat, 0 mg Cholesterol

FRESH AND FROZEN VEGETABLE TIMETABLE

When using the vegetable timetables below and on page 28, cook the vegetables the minimum amount of time indicated if you prefer your vegetables crisp. If you prefer your vegetables soft, cook them the maximum amount of time indicated. **TO PREVENT OVER-COOKING, COOL COOKER AT ONCE AFTER COOKING VEGETABLES, EXCEPT WHEN NOTED.**

If the timetable says to cook 0 minutes, this means to cook food until the pressure regulator begins to rock, then cool cooker at once.

Quantity of vegetables does not change pressure cooking times. More mature vegetables may require longer pressure cooking times than given in chart.

To assure even heating, separate a block of frozen vegetables.

For fresh and frozen vegetables, pour liquid into cooker. Place vegetables on rack in cooker.

*FOR FRESH AND FROZEN VEGETABLES,
DO NOT FILL PRESSURE COOKER OVER 2/3 FULL!*

FRESH VEGETABLE TIMETABLE

VEGETABLE	SIZE	CUPS OF LIQUID	COOKING TIME (MINUTES)
Artichoke	Whole, 6 to 8 ounces	1	10
Asparagus	Stems cut into 1-inch pieces	1	0 – 1
Beans (green, wax)	Whole or sliced	1	1 – 3
Beets	Whole, 2½-inch diameter	1½	15 – 16
Broccoli	Flowerets	1	0 – 2
Brussels Sprouts	Small, 1-inch diameter	1	1 – 3
Cabbage (red, green)	Wedges, 2-inch thick	1	3 – 5
	Thinly sliced	1	2 – 3
Carrots	Baby cut	1	3 – 5
	½-inch slices	1	3 – 5
Cauliflower	Flowerets	1	0 – 2
Collards*	Leaves coarsely chopped, stems thinly sliced	1	3 – 4
Corn on-the-cob	Whole, 2½-inch diameter	1	3
Eggplant	Cubed, 1 to 1½-inches thick	1	2 – 3
	Sliced, ½-inch thick	1	2
Kale	Leaves coarsely chopped, stems thinly sliced	1	1 – 2
Parsnips	Sliced, ½-inch thick	1	0 – 2

* Do not use rack; place in cooking liquid.

FRESH VEGETABLE TIMETABLE

VEGETABLE	SIZE	CUPS OF LIQUID	COOKING TIME (MINUTES)
Peas	Shelled	1	0 – 2
Peppers	Whole	1	0 – 3
Potatoes (sweet)	Sliced, 1 to 1½- inches thick	1	6 – 8
	Sliced, ½-inch thick	1	4 – 5
Potatoes (white)	Whole, 2½-inch diameter	1½	15
	Whole, 1½-inch diameter	1	10
	Sliced, ¾-inch thick	1	5
	Sliced, ½-inch thick	1	3
Rutabaga	Cubed or sliced, 1-inch thick	1	3
Spinach	Whole leaves	1	0
Squash (winter) acorn†	Quartered	1	12
Squash (winter) spaghetti†	Halved	1	12
Squash (yellow, zucchini)	Sliced, 1-inch thick	1	1
	Sliced, ¼ to ½-inch thick	1	0 – 1
Swiss Chard	Whole leaves	1	0 – 1
Turnips	Sliced or cubed, ¾-inch thick	1	3 – 5

† Let pressure drop of its own accord.

FROZEN VEGETABLE TIMETABLE

VEGETABLE	CUPS OF LIQUID	COOKING TIME (MINUTES)
Asparagus (cut, spears)	1	2
Beans (green, wax, french style)	1	1 – 2
Broccoli	1	1 – 2
Brussels Sprouts	1	2 – 3
Cauliflower	1	1 – 2
Corn Cut	1	1 – 2
Corn on Cob	1	2 – 3
Lima Beans	1	1 – 2
Mixed Vegetables	1	1 – 2
Peas	1	1 – 2
Peas and Carrots	1	1 – 2
Spinach	1	2 – 4

DRY BEANS AND PEAS

The pressure cooker is ideal for preparing dry beans and peas quickly. However, dry beans and peas have a tendency to froth and foam during cooking, which could cause the vent pipe to become blocked. **Therefore, it is necessary to use the following cautions when pressure cooking dry beans and peas:**

- (1) **Never fill the cooker over the ½ full line (this includes beans, ingredients, and water).**
- (2) **Add 1 tablespoon vegetable oil for cooking.**
- (3) **Allow pressure to drop of its own accord.**

SOAKING BEANS AND PEAS — Soaking is strongly recommended for all beans and peas, except lentils and black-eyed peas, for even cooking and to remove water-soluble, gas-producing starches. Soaking can be done using the traditional or the quick-soak method.

Traditional method: Clean and rinse beans; cover with three times as much water as beans. Soak 4 to 8 hours. Drain.

Quick method: Clean and rinse beans; cover with three times as much water as beans. Bring beans to a boil and boil for 2 minutes. Remove from heat, cover, and let stand for 1 to 2 hours. Drain.

COOKING BEANS AND PEAS — After soaking, rinse beans and remove any loose skins. Place beans in pressure cooker. Add fresh water to just cover the beans and add 1 tablespoon vegetable oil. Close cover securely. Place pressure regulator on vent pipe and cook according to the times in the timetable below. For more firm beans for salads and side dishes and when cooking less than 2 cups of beans or peas, use the shorter time. For soups and stews, use the longer time. **After cooking is complete, allow pressure to drop of its own accord.**

*FOR DRY BEANS AND PEAS,
DO NOT FILL PRESSURE COOKER OVER ½ FULL!
OPERATING THE COOKER WITHOUT COOKING LIQUID OR
ALLOWING THE COOKER TO BOIL DRY WILL DAMAGE THE COOKER.*

DRY BEANS AND PEAS TIMETABLE

Soak beans and peas, except lentils and black-eyed peas, according to information above.

Add 1 tablespoon vegetable oil to cooking liquid. DO NOT COOK SPLIT PEAS.

FOR DRY BEANS AND PEAS, DO NOT FILL PRESSURE COOKER OVER ½ FULL!

BEANS AND PEAS	COOKING TIME (MINUTES)
Adzuki	1 – 3
Anasazi	1 – 3
Black Beans	2 – 4
Black-eyed Peas	2 – 4*
† Chickpeas (garbanzo)	7 – 10
Great Northern Beans	2 – 5
Kidney Beans	1 – 3
Lentils (brown, green)	3 – 5*
† Lima Beans (large)	0 – 1
† Lima Beans (baby)	1 – 3
Navy Beans (pea)	1 – 3
Peas (whole yellow, green)	6 – 9
Pinto Beans	3 – 6
Red beans	3 – 6
Soy beans (beige)	8 – 11

* cooking time is for unsoaked beans

† add ½ to 1 teaspoon salt to soaking and cooking water to keep bean skins intact.

LENTIL CURRY

1	tablespoon vegetable oil	½	tablespoon curry powder
¾	cup chopped onion	½	teaspoon ground ginger
3	cups water	••••••	
1	cup lentils	½	teaspoon salt
½	tablespoon coriander		

Pour oil into cooker. Turn heat selector to medium and sauté onions. Add water, lentils, coriander, curry powder, and ginger. Close cover securely. Place pressure regulator on vent pipe and **cook 3 minutes with pressure regulator rocking slowly. Let pressure drop of its own accord.** Stir in salt.

Nutrition Information Per Serving
190 Calories, 2 g Fat, 0 mg Cholesterol

4 servings

BAKED BEANS

2	cups navy beans	1	medium onion, minced
3	cups water	⅓	cup brown sugar
¼	cup catsup	½	teaspoon dry mustard
¼	cup molasses	¼	teaspoon black pepper
1	8-ounce slice uncooked ham, diced	••••••	
			Salt to taste

Soak beans according to instructions on page 29. Drain. Add drained navy beans and remaining ingredients except salt to cooker. Close cover securely. Place pressure regulator on vent pipe and **cook 35 minutes with pressure regulator rocking slowly. Let pressure drop of its own accord.**

Nutrition Information Per Serving
264 Calories, 4 g Fat, 5 mg Cholesterol

6 servings

SAVORY WHITE BEANS

2	cups navy beans	1	small bay leaf
3	cups chicken broth	½	teaspoon thyme
1	cup chopped onion	¼	teaspoon rosemary
1	cup sliced carrots	¼	teaspoon black pepper
1	tablespoon minced garlic	••••••	
1	tablespoon vegetable oil		Salt to taste

Soak beans according to instructions on page 29; drain. Add all ingredients except salt to cooker. Close cover securely. Place pressure regulator on vent pipe and **cook 2 minutes with pressure regulator rocking slowly. Let pressure drop of its own accord.**

Nutrition Information Per Serving
254 Calories, 3 g Fat, 0 mg Cholesterol

7 servings

GRAINS

Grains are an important, but often little recognized, part of a healthy diet. They contribute complex carbohydrates, soluble and insoluble fiber, and other nutrients. Yet with all these benefits, grains are low in fat. Grains can be prepared quickly and conveniently with the pressure cooker. With a pressure cooker it is not necessary to soak or simmer grains for several hours.

During cooking many grains tend to froth, foam, and sputter and could cause the vent pipe to become blocked. Therefore, to contain frothing and foaming during the cooking period, grains must be prepared in a bowl covered with aluminum foil in the pressure cooker. Preparing grains in a bowl also minimizes cleanup which can be difficult if the grains stick to the bottom of the cooker.

The bowl can be metal, such as stainless steel, or oven-safe glass. If using glass, increase cooking time by 1 to 5 minutes depending on the length of the recommended cooking time.

FOR GRAINS, DO NOT FILL PRESSURE COOKER OVER ½ FULL!

*OPERATING THE COOKER WITHOUT COOKING LIQUID OR
ALLOWING THE COOKER TO BOIL DRY WILL DAMAGE THE COOKER.*

GRAIN TIMETABLE

Combine the desired grain and the amount of water or broth indicated in the table below in a bowl which fits loosely in the pressure cooker. Cover bowl securely with aluminum foil. Pour two cups water into cooker. Place bowl on rack in cooker. Close cover securely. Place pressure regulator on vent pipe and **cook for the time indicated in the table below. After pressure cooking, allow pressure to drop of its own accord.** Using tongs or hot pads, carefully remove bowl from cooker. Remove foil. Before serving, separate the grains by lifting gently with a fork while steaming. It may be necessary to allow excess moisture to evaporate from some grains. If excessive moisture remains, drain before using grains.

FOR GRAINS, DO NOT FILL PRESSURE COOKER OVER ½ FULL!

<u>GRAIN (1 CUP)</u>	<u>CUPS LIQUID IN BOWL</u>	<u>COOKING TIME (MINUTES)</u>
Amaranth	1¾	4 – 5
Barley (Hulled)	2½	25 – 28
Barley (Pearl)	2½	9 – 12
Buckwheat	2	3 – 4
Bulgar	1½	2 – 3
Millet	2	9 – 10
Oats (whole groats)	1½	20 – 25
Oats (steel cut)	2	4 – 5
Quinoa	1½	1
Rice (brown)	1½	10 – 12
Rice (white)	1½	5 – 8
Rye Berries	1½	20 – 25
Spelt	2	25 – 30
Wheat berries	2	25 – 30
Wild Rice	1½	20 – 25

SEASONED RICE PILAF

- | | |
|------------------------------|----------------------|
| 2 tablespoons margarine | 1/2 teaspoon salt |
| 1 small onion, chopped | 1/2 teaspoon oregano |
| 2 cups long grain white rice | 1/4 teaspoon pepper |
| 2 cups chicken broth | 2 cups water |
| 1 3/4 cups water | |

Place margarine in cooker. Turn heat selector to medium to melt margarine. Add onions; sauté until tender. Combine onion with rice, broth, 1 3/4 cup water, salt, oregano, and pepper in a metal bowl which will fit loosely in cooker. Cover bowl firmly with aluminum foil. Pour 2 cups water into cooker. Place bowl on rack in cooker. Close cover securely. Place pressure regulator on vent pipe and **cook 5 minutes with pressure regulator rocking slowly. Let pressure drop of its own accord.** Open cooker, remove foil, and set rice aside to steam.

Nutrition Information Per Serving 8 servings
210 Calories, 4 g Fat, 0 mg Cholesterol

VARIATION: GRECIAN RICE PILAF

After pressure has dropped of its own accord, combine rice, 3/4 cup peas, 1/2 cup sliced ripe olives, and 1 red pepper, coarsely chopped. Allow rice to steam uncovered 5 minutes.

LEMON RICE

- | | |
|--------------------------|---------------------------|
| 1 cup long grain rice | 2 cups water |
| 1 1/2 cups chicken broth | •••••• |
| 2 teaspoons lemon juice | 1/4 teaspoon grated lemon |
| 3/4 teaspoon salt | rind |

Combine rice, chicken broth, lemon juice, and salt in a metal bowl which fits loosely in cooker. Cover bowl firmly with aluminum foil. Pour 2 cups water into cooker. Place bowl on rack in cooker. Close cover securely. Place pressure regulator on vent pipe and **cook 5 minutes with pressure regulator rocking slowly. Let pressure drop of its own accord.** Open cooker, remove foil, and set rice aside to steam for 5 minutes. Stir in lemon rind.

Nutrition Information Per Serving 4 servings
183 Calories, 0 g Fat, 0 mg Cholesterol

WILD RICE WITH RAISINS AND PECANS

- | | |
|--------------------------------|-------------------------|
| 1 tablespoon vegetable oil | 2 cups water |
| 1 medium onion, finely chopped | •••••• |
| 1 1/2 cups wild rice | 3/4 cup golden raisins |
| 2 cups beef broth | 1/3 cup pecans, toasted |

Pour oil into cooker. Turn heat selector to medium and sauté onion. Combine onion with wild rice and beef broth in a metal bowl which fits loosely in cooker. Cover bowl firmly with aluminum foil. Pour water into cooker. Place bowl on rack in cooker. Close cover securely. Place pressure regulator on vent pipe and **cook 25 minutes with pressure regulator rocking slowly. Let pressure drop of its own accord.** Open cooker and remove aluminum foil; add raisins and allow to steam for 5 minutes. Remove bowl from cooker; stir in pecans.

Nutrition Information Per Serving 8 servings
167 Calories, 5 g Fat, 0 mg Cholesterol

RISOTTO WITH ARTICHOKE HEARTS AND SUN-DRIED TOMATOES

1	tablespoon olive oil	1	can (13¾ ounces) artichoke hearts, drained and coarsely chopped
1	cup arborio rice		
2	cloves garlic, minced	¼	cup grated Parmesan cheese
2	cups chicken broth	1½	tablespoons fresh thyme or 1½ teaspoons dried thyme
⅓	cup white wine		Salt and pepper to taste
⅓	cup dried tomatoes, chopped		
2	cups water		
	••••••••		

Heat oil in pressure cooker over medium heat; add rice and stir for 2 minutes until coated and slightly translucent. Add garlic and cook for 1 minute. Combine rice, garlic, broth, white wine, and tomatoes in a metal bowl which fits loosely in cooker. Cover bowl firmly with aluminum foil. Pour water into cooker. Place bowl on rack in cooker. Close cover securely. Place pressure regulator on vent pipe and **cook 8 minutes with pressure regulator rocking slowly. Let pressure drop of its own accord.** Open cooker and remove foil. Stir artichoke hearts, Parmesan cheese, and thyme into rice.

Nutrition Information Per Serving
220 Calories, 5 g Fat, 4 mg Cholesterol

4 servings

DESSERTS

Add a fabulous finale to any meal with desserts prepared in your pressure cooker. Pressure cooking gives an even texture to pudding and a satiny feel to custards.

Desserts may be prepared in oven-safe custard cups or any metal mold which will fit loosely in the pressure cooker. Fill molds only ⅔ full to allow for expansion of food. Cover securely with aluminum foil shaped to the sides of the mold. Place the mold or custard cups on the cooking rack in the cooker. Up to three custard cups of dessert can be pressure cooked at a time in the 4-quart cooker and up to six in the 6-quart cooker. For the 6-quart cooker, place three custard cups on the cooking rack. Then, stack the other three custard cups opposite the bottom three custard cups.

To test custards for doneness, insert a knife into the center. If the knife comes out clean, it is done. If not, it will be necessary to bring the cooker back up to pressure and cook the custard a minute or two longer.

Do not cook applesauce, cranberries, or rhubarb in the pressure cooker.

*FOR DESSERTS, DO NOT FILL
PRESSURE COOKER OVER ⅔ FULL!*

*OPERATING THE COOKER WITHOUT COOKING LIQUID OR
ALLOWING THE COOKER TO BOIL DRY WILL DAMAGE THE COOKER.*

STUFFED APPLES

¼	cup golden raisins	½	teaspoon ground cinnamon
½	cup dry red wine	4	cooking apples
¼	cup chopped nuts	1	tablespoon butter
2	tablespoons sugar	1	cup water
½	teaspoon grated orange rind		

Soak raisins in wine for at least 30 minutes. Drain, reserving wine. Combine raisins, nuts, sugar, orange rind, and cinnamon. Core apples, cutting to but not through bottoms. Peel top one-third of apples. Place each apple on square of aluminum foil that is large enough to completely wrap apple. Fill centers with raisin mixture. Top each with one-fourth of the butter. Wrap foil around apple, pinching firmly together at top. Place reserved wine, water, and apples in cooker. Place pressure regulator on vent pipe and **cook 10 minutes with pressure regulator rocking slowly. Cool cooker at once.**

Nutrition Information Per Serving
224 Calories, 8 g Fat, 8 mg Cholesterol

4 servings

RICE PUDDING

- | | |
|-----------------------------|---------------------|
| 1 cup long-grain white rice | ½ cup sugar |
| 1½ cups water | ½ cup raisins |
| 1 cup water | ½ teaspoon cinnamon |
| •••••••• | |
| 1 cup whole milk | |

Combine rice and 1½ cups water in a metal bowl which fits loosely in cooker. Cover bowl firmly with aluminum foil. Pour 1 cup water into cooker. Place bowl on rack in cooker. Close cover securely. Place pressure regulator on vent pipe and **cook 10 minutes with pressure regulator rocking slowly. Cool cooker at once.** Stir milk, sugar, raisins, and cinnamon into rice. Cover bowl firmly with aluminum foil. Place bowl on rack in cooker. Close cover securely. Place pressure regulator on vent pipe and **cook 3 minutes with pressure regulator rocking slowly. Let pressure drop of its own accord.**

Nutrition Information Per Serving
238 Calories, 2 g Fat, 24 mg Cholesterol

6 servings

VANILLA CUSTARD

- | | |
|-------------------------|--------------------|
| 2 cups lowfat milk | ½ teaspoon vanilla |
| 2 eggs, slightly beaten | Nutmeg |
| ¼ cup sugar | 1 cup water |
| ¼ teaspoon salt | |

Combine milk, eggs, sugar, salt, and vanilla. Pour into individual custard cups. Sprinkle nutmeg on custards. Cover each cup firmly with aluminum foil. Pour water into cooker. Place custard cups on rack in cooker. Close cover securely. Place pressure regulator on vent pipe and **cook 5 minutes with pressure regulator rocking slowly. Cool cooker at once.** Chill.

Nutrition Information Per Serving
137 Calories, 4 g Fat, 118 mg Cholesterol

4 servings

VARIATION: COCONUT CUSTARD

Sprinkle 1 tablespoon coconut over top of each vanilla custard before cooking.

PETITE PUMPKIN CUSTARDS

- | | |
|--|--|
| 1 can (16 ounces) solid-pack pumpkin | 1 teaspoon finely chopped candied ginger, optional |
| 1 can (14 ounces) sweetened condensed milk | ¼ teaspoon ground cloves |
| 3 eggs, beaten | 1 cup water |
| 1 teaspoon ground cinnamon | •••••••• |
| | Whipped cream, optional |

Mix pumpkin, milk, eggs, cinnamon, ginger, and cloves. Pour into individual custard cups. Cover each cup firmly with aluminum foil. Pour water into cooker. Place custard cups on rack in cooker. Close cover securely. Place pressure regulator on vent pipe and **cook 10 minutes with pressure regulator rocking slowly. Cool cooker at once.** Refrigerate until chilled. Serve with whipped cream, if desired.

Nutrition Information Per Serving
207 Calories, 6 g Fat, 97 mg Cholesterol

8 servings

TAPIOCA PUDDING

2 cups lowfat milk	$\frac{1}{3}$ cup sugar
2 tablespoons quick cooking tapioca	$\frac{1}{2}$ teaspoon vanilla
2 eggs, slightly beaten	1 cup water

Scald milk and tapioca. Remove from heat and let stand 15 minutes. Combine eggs, sugar, and vanilla. Add milk and tapioca, stirring constantly. Pour into individual custard cups. Cover firmly with aluminum foil. Pour water into cooker. Place custard cups on rack in cooker. Place pressure regulator on vent pipe and **cook 5 minutes with pressure regulator rocking slowly. Cool cooker at once.** Chill.

Nutrition Information Per Serving

6 servings

113 Calories, 3 g Fat, 75 mg Cholesterol

OATMEAL APPLE CRISP

4 cups apples, peeled and sliced	2 tablespoons flour
1 tablespoon lemon juice	1 teaspoon cinnamon
$\frac{1}{2}$ cup quick cooking oats	2 tablespoons margarine, softened
$\frac{1}{4}$ cup brown sugar	2 cups water

Sprinkle apples with lemon juice. Combine oats, brown sugar, flour, and cinnamon. Cut in margarine until coarse meal forms. Place apples in a greased bowl that will loosely fit in cooker. Sprinkle oat mixture evenly over apples. Cover bowl firmly with aluminum foil. Pour water into cooker. Place bowl on rack in cooker. Close cover securely. Place pressure regulator on vent pipe and **cook 20 minutes with pressure regulator rocking slowly. Cool cooker at once.**

Nutrition Information Per Serving

4 servings

209 Calories, 7 g Fat, 0 Cholesterol

CHEESECAKE

1 8-ounce package cream cheese	$\frac{1}{2}$ cup vanilla wafer crumbs
1 3-ounce package cream cheese	$2\frac{1}{2}$ cups water
$\frac{1}{2}$ cup sugar	
2 eggs	

Beat cream cheese until smooth. Add sugar and beat in eggs. Pour mixture into buttered custard cups. Top with vanilla wafer crumbs. Cover each cup firmly with aluminum foil. Pour water into cooker. Place custard cups on rack in cooker. Close cover securely. Place pressure regulator on vent pipe and **cook 15 minutes with pressure regulator rocking slowly. Cool cooker at once.** Cool cheesecake. Cut around inside of cups to loosen and invert onto serving dish. Chill. Top with one of the following sauces, if desired.

Nutrition Information Per Serving

6 servings

305 Calories, 23 g Fat, 157 Cholesterol

CARAMEL SAUCE — Combine $\frac{1}{4}$ cup soft cream cheese, $\frac{1}{4}$ cup brown sugar, 1 tablespoon granulated sugar, and $\frac{1}{4}$ teaspoon vanilla. Mix thoroughly. Spoon over cheesecake. Garnish with pecans. Refrigerate until serving.

FRUIT SAUCE — Spoon canned fruit pie filling of your choice over cheesecake. Refrigerate until serving.

RECIPE INDEX

SOUPS AND STOCKS 10		
Beef Tomato Soup 11	Chicken and Dressing 18	Maple Glazed Sweet Potatoes. 26
Black Bean Soup 11	Chutney Chicken 17	DRY BEANS AND PEAS 29
Brown Beef Soup 11	Herbed Chicken 18	Baked Beans 30
Brown Beef Soup Stock 11	Poultry Timetable 19	Dry Beans and Peas Timetable 29
Chicken Dumpling Soup 10	Soy Chicken 17	Lentil Curry 30
Chicken Noodle Soup 10	Sweet 'N Sour Chicken 17	Savory White Beans 30
Chicken Rice Soup 10	Turkey Breast 19	
Chicken Soup 10	MEATS 20	GRAINS 31
Chicken Soup Stock 10	Apricot Barbecue Pork Roast 22	Grain Timetable 31
Minestrone 12	Barbecue Spareribs 22	Grecian Rice Pilaf 32
Onion Soup 11	Beef Pot Roast 20	Lemon Rice 32
Potato Soup 12	Beef Stew 21	Risotto with Artichoke Hearts and Sun-Dried Tomatoes 33
Saffron Fish Stew 12	Corned Beef 22	Seasoned Rice Pilaf 32
Zesty Homemade Chili 13	Lamb Stew 24	Wild Rice with Raisins and Pecans 32
SEAFOOD 13	Meat Timetable 24	DESSERTS 33
Lemon 'N Dill Cod and Broccoli 14	Porcupine Meatballs 20	Coconut Custard 34
Marinated Tuna 15	Pork Loin Roast 23	Cheesecake 35
Salmon Steaks Moutarde 13	Spaghetti Meat Sauce 21	Oatmeal Apple Crisp 35
"Scampi Style" Shrimp 14	Stuffed Flank Steak 23	Petite Pumpkin Custards 34
Seafood Gumbo 15	Stuffed Pork Chops 23	Rice Pudding 34
Seafood Timetable 15	Swiss Steak 21	Stuffed Apples 33
Shrimp Jambalaya 14	VEGETABLES 25	Tapioca Pudding 35
POULTRY 16	Artichokes 'N Sauce 26	Vanilla Custard 34
Bayou Bounty Chicken 19	Cabbage with Apples 25	
California Chicken 16	Fresh Vegetable Timetable 27	
Chicken Breasts Tarragon 16	Frozen Vegetable Timetable 28	
Chicken Cacciatore 18	Garlic Mashed Potatoes 26	
	Glazed Root Vegetables 25	

SERVICE AND PARTS INFORMATION

If you have any questions regarding the operation of your Presto® cooker or need parts for your cooker, contact us by any of these methods:

- **Call 1-800-877-0441** weekdays 8:00 AM to 4:30 PM (Central Time)
- **Email us at our website www.GoPresto.com**
- **Write: NATIONAL PRESTO INDUSTRIES, INC.**
Consumer Service Department
3925 N. Hastings Way, Eau Claire, WI 54703-3703

Inquiries will be answered promptly by telephone, letter, or email. When writing, please include a phone number and a time when you can be reached during weekdays, if possible.

When contacting the consumer service department or when ordering replacement parts, please specify the model number and date code found stamped on the side of the cooker body.

Any maintenance required for this cooker, other than that described in the Care and Maintenance section of this book (pages 12 through 15), should be performed by our Factory Service Department. Be sure to indicate date of purchase and a description of the problem when sending a cooker for repair. **Send cookers for repair to:**

CANTON SALES AND STORAGE COMPANY
Presto Factory Service Department
555 Matthews Drive, Canton, MS 39046-0529

The Presto Factory Service Department is equipped to service all PRESTO® appliances and supply genuine PRESTO® parts. Genuine PRESTO® replacement parts are manufactured to the same exacting quality standards as PRESTO® appliances and are engineered specifically to function properly with its appliances. Presto can only guarantee the quality and performance of genuine PRESTO® parts. “Look-alikes” might not be of the same quality or function in the same manner. To ensure that you are buying genuine PRESTO® replacement parts, look for the PRESTO® trademark.

Cooker replacement parts are available at Presto Authorized Service Stations and may also be available at hardware stores and other retail outlets. Parts may also be ordered on-line at www.GoPresto.com.

PRESTO® Limited Warranty

This quality PRESTO® appliance is designed and built to provide many years of satisfactory performance under normal household use. Presto pledges to the original owner that should there be any defects in material or workmanship during the first twelve (12) years after purchase, we will repair or replace it at our option. Our pledge does not apply to normal wear and tear including scratches, dulling of the polish, or staining; the repair or replacement of moving and/or perishable parts such as the sealing ring, overpressure plug, or air vent cover lock gasket; or for any damage caused by shipping. To obtain service under the warranty, return this PRESTO® product, shipping prepaid to the PRESTO® Factory Service Department. California residents may deliver this PRESTO® product to their nearest PRESTO® Authorized Service Station. When returning a product, please include a description of the defect and indicate the date the appliance was purchased.

We want you to obtain maximum enjoyment from using this PRESTO® appliance and ask that you read and follow the instructions enclosed. Failure to follow instructions, damage caused by improper replacement parts, abuse or misuse (including overheating and boiling the unit dry) will void this pledge. This warranty gives you specific legal rights, and you may also have other rights which vary from state to state. This is Presto's personal pledge to you and is being made in place of all other express or implied warranties.

NATIONAL PRESTO INDUSTRIES, INC.
Eau Claire, Wisconsin 54703-3703