

This Owner's Manual is provided and hosted by [Appliance Factory Parts](#).



PRESTO 01/C17 Owner's Manual

[Shop genuine replacement parts for PRESTO 01/C17](#)

PRESTO®

[Find Your PRESTO Pressure Cooker Parts - Select From 250 Models](#)

----- Manual continues below -----

PRESTO®

Pressure Canner and Cooker



Visit us on the web at www.GoPresto.com



Instructions and Recipes

©2006 by National Presto Industries, Inc.

TABLE OF CONTENTS

Important Safeguards	2
Getting Acquainted	2
Before Using the Canner for the First Time	4
How to Use Your Canner	4
Pressure Canning	5
How to Pressure Can Foods	6
Care and Maintenance	7
Pressure Canning Fruits and Tomatoes	8
Pressure Canning Vegetables	12
Pressure Canning Meat	15
Pressure Canning Poultry	16
Pressure Canning Fish and Seafood	17
Pressure Canning Soups	18
Helpful Hints For Pressure Canning	18
How To Can Foods Using Boiling Water Method	19
Pressure Cooking in Your Pressure Canner	21
How to Pressure Cook Foods	21
Important Safety Information	22
Helpful Hints for Pressure Cooking	23
Pressure Cooking Meat	24
Pressure Cooking Entrees	28
Pressure Cooking Poultry	31
Pressure Cooking Soups	33
Pressure Cooking Desserts	34
Recipe Index	36
Service and Parts Information	37
Warranty	37

This is a  Listed appliance. The following Important Safeguards are recommended by most portable appliance manufacturers.

IMPORTANT SAFEGUARDS

To reduce the risk of personal injury or property damage, basic safety precautions should always be followed, including the following:

1. Read all instructions. Improper use may result in bodily injury or property damage.
2. Always check the vent pipe before use. Hold cover up to light and look through vent pipe to be certain it is clear.
3. Always check the air vent/cover lock to be sure it moves freely before use.
4. Do not fill pressure canner over $\frac{2}{3}$ full when using for pressure cooking. For soup, rice, and dried vegetables which expand during cooking, do not fill canner over $\frac{1}{2}$ full. Overfilling may cause a risk of clogging the vent pipe and developing excess pressure. See food preparation instructions.
5. Do not pressure cook applesauce, cranberries, rhubarb, pearl barley, cereals, pastas, grains, split peas, or soup mixes containing dry beans or peas. These foods tend to foam, froth, and sputter and may block the vent pipe, overpressure plug, and air vent/cover lock.
6. This appliance cooks under pressure. Improper use may result in scalding injury. Make certain pressure canner is properly closed before operating; cover handles must be directly above the body handles. See “How To Use” instructions.
7. Do not place the pressure canner or attempt to pressure can or cook in a heated oven.
8. **Caution: Do not use pressure canner on an outdoor LP gas burner or gas range over 12,000 BTU’s.**
9. Extreme caution must be used when moving a pressure canner containing hot liquids. Do not touch hot surfaces. Use handles or knobs.
10. Do not open canner until internal pressure has been completely reduced, air vent/cover lock has dropped, and no steam escapes when the pressure regulator is removed. See “How To Use” instructions.
11. **Caution:** To ensure safe operation and satisfactory performance, replace the overpressure plug every time you replace the sealing ring or sooner if it becomes hard, deformed, cracked, worn, or pitted. It is recommended that the sealing ring and overpressure plug be replaced at least every three years.
12. Close supervision is necessary when the pressure canner is used near children. It is not recommended that children use the pressure canner.
13. When normal operating pressure is reached, the pressure regulator will begin to rock. Gradually lower the heat as necessary to maintain the pressure. If the pressure regulator is allowed to rock vigorously, excess steam will escape, liquid will be evaporated, and food may scorch.
14. Do not use this pressure canner for other than intended use.
15. Do not use this pressure canner for pressure frying with oil.

SAVE THESE INSTRUCTIONS

THIS PRODUCT IS FOR HOUSEHOLD USE ONLY.

GETTING ACQUAINTED

Your canner is a special, large capacity pressure vessel designed for home canning a wide variety of fruits, vegetables, meats, and poultry. The canner may also be used to fast cook many of your favorite foods in larger quantities than can be prepared in a conventional size pressure cooker.

The canner uses pressure to achieve the high temperatures required for safely processing foods while canning. The United States Department of Agriculture recommends the pressure canner as the only safe method for canning low-acid foods—vegetables, meats, and poultry.

The canner will also cook many foods in one-third to one-tenth the time required by conventional methods. Pressure cooking preserves flavor and nutrients and tenderizes tougher cuts of meat.

It is necessary to follow a few special rules in using and caring for your Pressure Canner. Become familiar with the various parts as shown in the diagram on page 3 and read the “How To Use” sections beginning on Pages 4, 6, 19, and 21, before using for the first time.

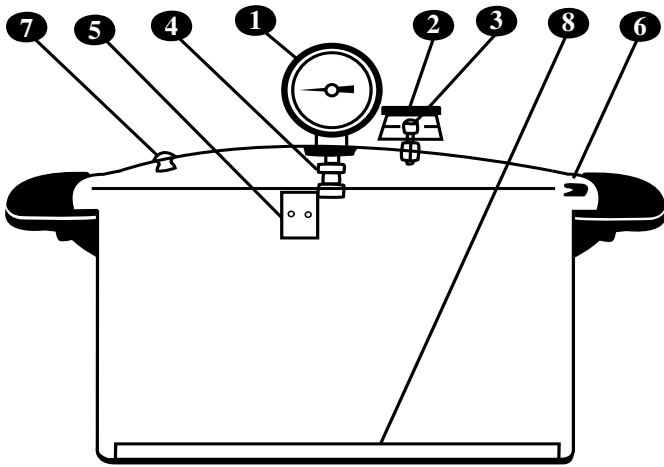

1. PRESSURE DIAL GAUGE

The pressure dial gauge registers pressure in both pounds (outer scale) and metric measure (inner scale). The pointer moves around the dial indicating the pressure within the unit. Pressure can be controlled and maintained by adjusting heat setting.

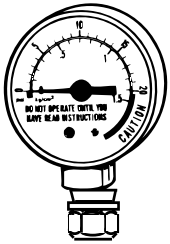

2. PRESSURE REGULATOR

The pressure regulator acts as a safety device to prevent pressure in excess of 15 pounds from building in the canner. Pressure readings on the pressure canner are registered only on the pressure dial gauge.



3. VENT PIPE

The pressure regulator fits over the vent pipe and allows excess pressure to be released.

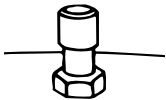

4. AIR VENT/COVER LOCK

The air vent/cover lock automatically “vents” or exhausts air from the canner and acts as a visual indication of pressure in the canner. The small gasket must be in place for the air vent/cover lock to seal completely.

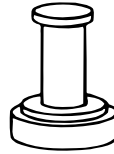

5. LOCKING BRACKET

The locking bracket on the inside of the canner body engages with the air vent/cover lock to prevent the cover from being opened when there is pressure in the unit.

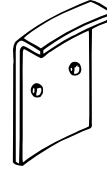

6. SEALING RING

The sealing ring fits into the canner cover and forms a pressure-tight seal between the cover and body during canning and cooking.

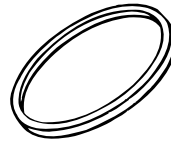

7. OVERPRESSURE PLUG

The overpressure plug is located in the canner cover. It will automatically pop out and release steam in case the vent pipe becomes blocked and/or clogged and pressure cannot be released normally through the vent pipe.



8. CANNING-COOKING RACK

The canning-cooking rack is placed in the bottom of the canner to hold jars off the bottom of the unit while canning. When cooking, the rack is used for steaming foods. It can also be used to hold foods such as vegetables out of the cooking liquid which allows several foods to be cooked at the same time without an intermingling of flavors. When it is desirable to blend flavors, do not use the canning-cooking rack. The canning-cooking rack must always be used when canning.

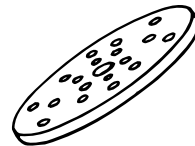

REPLACEMENT PARTS

PRESTO® Canner parts are available at most hardware stores or see parts information on page 37. When ordering parts, please specify the seven digit model number found stamped on the side of the canner body.

BEFORE USING CANNER FOR THE FIRST TIME

1. Remove the air vent/cover lock from the canner cover. The cup portion of the air vent/cover lock, on the inside of the cover, unscrews from the pin (Fig. A).
2. Remove the sealing ring by simply pulling it from the sealing ring groove.
3. Remove the overpressure plug by pushing it out of its opening from the top of the cover.
4. Wash the cover, body, and sealing ring with hot, sudsy water to remove any manufacturing oils.
5. Reinsert the air vent/cover lock making sure the small gasket is in place as shown (Fig. B).
6. Reinsert the overpressure plug by pushing the domed side of the plug into the opening from the underside of the cover, until the bottom edge is fully and evenly seated against the underside of the cover (Fig. C). When the overpressure plug is properly installed, the word (TOP) will be visible on the overpressure plug when viewing the outside of the cover.
7. Replace the sealing ring in the sealing ring groove, making certain to fit the ring under the stop tab located on the inside rim of the cover (Fig. D).
8. The sealing ring is prelubricated. If necessary, to help make the cover easier to open and close, a very light coating of cooking oil may be applied to the sealing ring and underside of the body lugs (Fig. E). The cover should open and close easily when following the instructions on page 5.
9. To attach the dial gauge to the canner cover, first remove the nut, metal washer, and white compression gasket from the threaded end of the dial gauge. Then, turn the cover upside down and starting from the bottom, insert the threaded end of the dial gauge up through the hole in the center of the cover until the metal base rests on the cover. While holding the dial gauge in place, position the gasket (the gasket should rest within the cover hole), metal washer, and then the nut on the threaded end of the gauge (Fig. F) and tighten with fingers. If necessary, lightly tighten with a wrench.

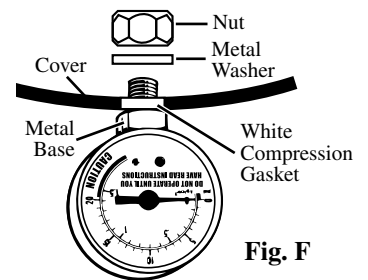
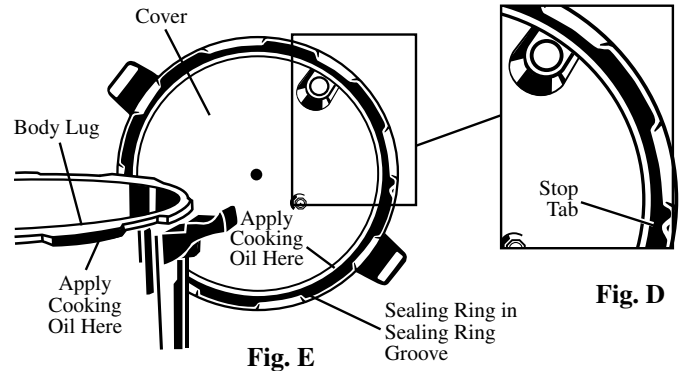
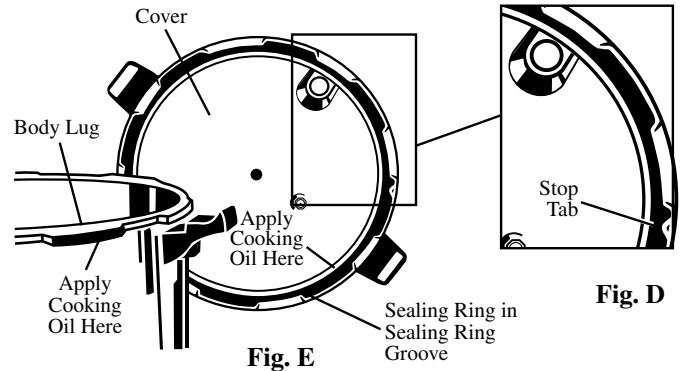
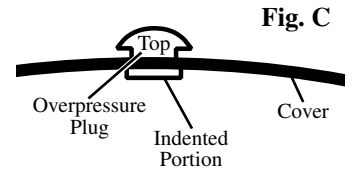
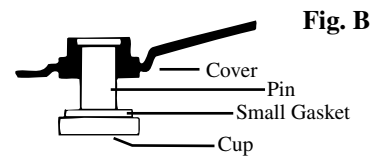
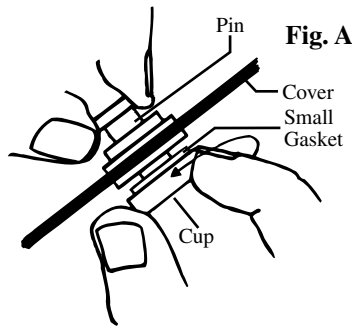

HOW TO USE YOUR CANNER

IMPORTANT: Read carefully. Do not attempt to use your Pressure Canner before reading these instructions.

- ◆ Before using your canner for the first time, clean according to the instructions above.
- ◆ Be sure the vent pipe is open before each use by holding the cover up to the light and looking through the vent pipe (Fig. G). If the vent pipe is blocked, excess pressure cannot be released through it. Pressure may then build to unsafe levels. Pressure will continue to build until the overpressure plug is forced out of its cover opening. Therefore, clean the vent pipe with a small brush or pipe cleaner if it is blocked or partially blocked (Fig. H). Also clean the vent pipe nut as shown.
- ◆ Pressure for canning is indicated by the pressure dial gauge (Fig. I). The pointer will move across the dial as pressure is developed or reduced within the canner. The pressure regulator is designed to rock only at 15 pounds pressure.

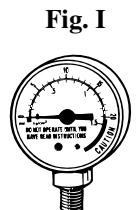
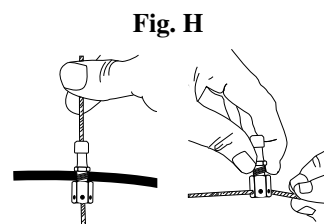
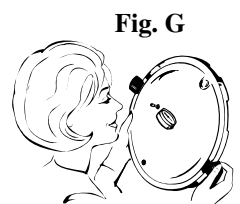

- ◆ Use the canner on a level burner and range only. Use on a tilted burner or range may interfere with the operation of the pressure regulator. **Caution: Do not use pressure canner on an outdoor LP gas burner or gas range over 12,000 BTU's.**
- ◆ The canner has been designed so the cover will go on in only one position and rotate in only the directions indicated for closing and opening. Press down on the cover handles to compress the sealing ring and make the cover easier to close. The cover has the words **CLOSE V OPEN** embossed on the top surface near a cover handle. Align the **V** mark on the cover with the **A** mark on the body handle for proper cover and body alignment (Fig. J). Turn the cover in the direction indicated to close (clockwise) until the cover handles are centered directly above body handles. Do not rotate cover beyond this point.

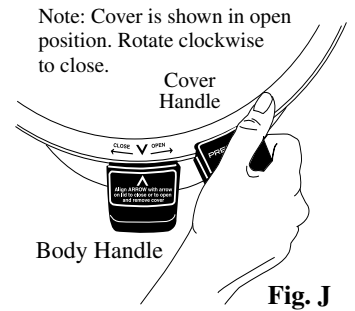

When the cover is rotated to the closed position, the air vent/cover lock passes under the locking bracket. When the handles are aligned, one over the other, the pressure regulator is placed on the vent pipe, and heat is applied, pressure will begin to build within the canner. At this point, the air vent/cover lock lifts and locks the unit. The cover will remain locked as long as there is pressure in the canner. When pressure is completely reduced, the air vent/cover lock drops allowing the canner to be opened (Fig. K).

If the cover is not rotated sufficiently (cover handles directly above body handles), the air vent/cover lock will only raise slightly and steam will continue to flow from it, preventing pressure from building.

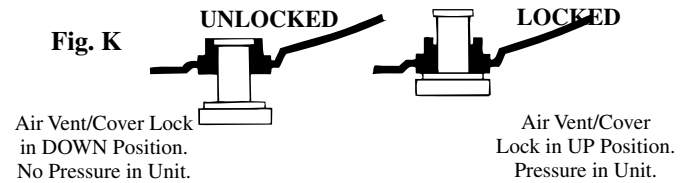

- ◆ The pressure regulator is placed on the vent pipe following the 10-minute exhaust period (see page 7, step 7). During canning, moisture may appear near the pressure regulator, overpressure plug, and air vent/cover lock. This is normally due to condensation. This does not affect operation of the canner.
- ◆ To reduce pressure at the end of the canning period, turn burner off and remove the canner from the heat source. Pressure is completely reduced when the air vent/cover lock has dropped and no steam escapes when the pressure regulator is tilted. **Do not remove the pressure regulator until pressure is completely reduced. Always remove the pressure regulator before opening canner.**

If the air vent/cover lock remains in its raised position, there may still be pressure in the canner. Do not remove the pressure regulator until the air vent/cover lock drops and no steam escapes when the pressure regulator is tilted. The cover should not be forced open. You may tap the air vent/cover lock lightly with a spoon. If pressure is present, steam will escape and the air vent/cover lock will pop back up. Continue to cool the canner until the air vent/cover lock drops.

HELPFUL HINT: To help yourself understand the operation of the pressure canner and cooker, pour 4 cups of water into the canner and follow the step-by-step instructions beginning with step 5 on page 6. For actual usage of the canner/cooker, follow the complete instructions beginning on page 6 for pressure canning and on page 21 for pressure cooking.

PRESSURE CANNING

The United States Department of Agriculture recommends the pressure canner as being the only safe method for canning low acid foods—vegetables, meats, and poultry.

There are invisible microorganisms present all around us. Fruits, vegetables, and meat contain these microorganisms naturally, and yet, they are not a problem unless food is left to sit for extended periods of time, causing food spoilage. This is nature's way of telling us when food is no longer fit to eat.

There are four basic agents of food spoilage—enzymes, mold, yeast, and bacteria. Canning interrupts the natural spoilage cycle so food can be preserved safely. Molds, yeast, and enzymes are destroyed at temperatures below 212°F, the temperature at which water boils (except in mountainous regions). Therefore, boiling water processing is sufficient to destroy those agents.

Bacteria, however are not as easily destroyed. The bacteria, *Clostridium botulinum* produces a spore that makes a poisonous toxin which causes botulism. This spore is not destroyed at 212°F. In addition, the bacteria thrive on low acids in the absence of air. For a safe food product, low acid foods need to be processed at 240°, which can be achieved only with a pressure canner.

In pressure canning, some of the water in the pressure canner is converted to steam, which creates pressure within the canner. As pressure increases, temperature increases, 5 pounds pressure—228°F, 10 pounds pressure—240°F, 15 pounds pressure—250°F. This pressurized heat destroys the potentially harmful bacterial spores. As the jars cool, a vacuum is formed, sealing the food within and preventing any new microorganisms from entering and spoiling the food.

As a safeguard against using canned foods which may be affected with spoilage that is not readily detected, boil all low acid foods and tomatoes for 10 minutes at altitudes below 1,000 feet. Extend the boiling time by 1 minute for each 1,000 foot increase in altitude.

Many times odors that cannot be detected in the cold product will become evident by these methods. If, after boiling, food does not smell or look right, **discard it without tasting.**

MASON JARS: While there are many styles and shapes of glass jars on the market, only Mason jars are recommended for home canning. Mason jars are available in ½ pint, pint, and quart capacities with threads on which a cap may be screwed. See the chart below for the jar capacity of your canner. Additional information may be obtained from the manufacturers of Mason jars.

CLOSURES FOR MASON JARS: The two-piece vacuum cap consists of a flat metal lid held in place with a screw band. A rubber compound on the underside of the lid forms a seal during processing. Follow the closure manufacturer’s directions for using the two-piece cap and for testing for a proper seal. If the closure has not sealed, completely reprocess or use the food immediately. Refer to the closure manufacturer’s directions for additional information.

CANNER JAR CAPACITIES FOR PRESSURE CANNING (MAXIMUM CAPACITY)

MODEL NO. beginning with	½ PINT	1 PINT	1 QUART
0175	12	10	7
0178	24	20	7

Please note: To double deck pint and half pint jars, see page 19.

HOW TO PRESSURE CAN FOODS

IMPORTANT: Read carefully. Do not attempt to use your canner before reading these instructions.

Follow these step-by-step instructions for pressure canning in your canner. Prepare food according to the directions in specific recipe.

1. The first step in pressure canning is to assemble the canning equipment. Be sure your canner is thoroughly cleaned and working properly. Before each canning season, check the dial gauge for accuracy (see page 8, step 11). Also check the sealing ring, overpressure plug, and the rubber gasket of the air vent/cover lock. Replace these parts when they become hard, deformed, cracked, worn, pitted, or unusually soft (see page 8, step 13).

2. Check Mason jars for nicks, cracks, and sharp edges. Check screw bands for dents or rust. Use only jars, lids, and bands in perfect condition so an airtight seal may be obtained.

Wash and rinse jars, lids, and bands. Pour hot water into jars and set aside until needed. Follow closure manufacturer’s directions for bands and lids.

3. Select fresh firm food. Sort food according to size. Clean food thoroughly. Prepare according to recipe. Fill hot Mason jars promptly with food and liquid to recommended level. Allow ½-inch headspace for fruits. ALL vegetables and meats require 1-inch headspace due to expansion during processing.

Work out air bubbles with a clean nonmetallic spatula. Wipe sealing edge clean with a damp cloth.

Adjust bands according to closure manufacturer’s directions.

4. Place 3 quarts of boiling water, canning rack, and jars in canner. To prevent water stains on jars, add 2 tablespoons white vinegar to water in canner. Always use canning rack. Jars may break if set directly on bottom of canner.

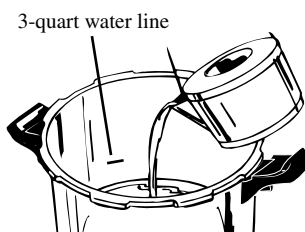

5. Look through the vent pipe to be certain it is open before placing cover on canner. To clean the vent pipe, draw a pipe cleaner or small brush through the opening.

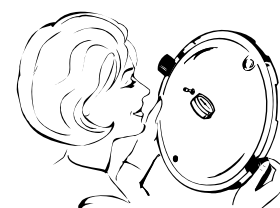

6. Place cover on canner, aligning the V mark on the cover with the A mark on the body handle and lock securely by turning in the direction indicated to close (clockwise). **Cover handles must be centered over body handles. Do not force beyond this position.**



7. Exhaust air from the canner and jars by adjusting heat to a relatively high setting to obtain a free flow of steam from the vent pipe. Consult the instruction book which accompanied your range for recommended heat setting. Reduce heat to maintain a moderate steam flow. Allow steam to flow for 10 minutes.

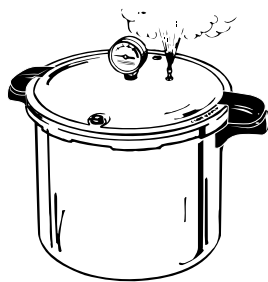

8. Place pressure regulator on vent pipe. Set burner at a relatively high heat setting, on most range burners, and heat canner until pressure dial gauge registers desired pressure.

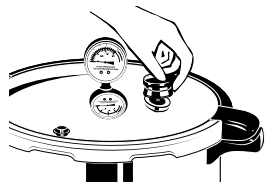

9. Processing time begins when pressure gauge registers the correct pressure. Adjust heat to maintain correct pressure on the dial gauge.

10. At end of processing time, turn burner to "OFF" and remove canner from heat source. Lift pressure canner to remove it from burner. Sliding cookware can leave scratches on stovetops.

11. **Let pressure drop of its own accord, do not quick-cool.** Pressure is completely reduced when the air vent/cover lock and overpressure plug have dropped and no steam escapes when the pressure regulator is tilted. Do not use the pressure dial gauge as an indicator for when pressure

is completely reduced. Attempting to speed the cooling of the canner may cause jar breakage.

12. When pressure has been completely reduced, remove pressure regulator from vent pipe and let canner cool for 10 minutes. **Do not** remove the pressure regulator until pressure is completely reduced and the air vent/cover lock has dropped. **Always** remove pressure regulator before opening the cover.

13. To remove cover, turn counter-clockwise until cover hits stop. Cover handles will be beyond the body handles. If cover seems to stick or is hard to turn, do not force it open. Sticking may indicate that there is still pressure inside the canner. If in doubt about pressure being completely reduced, let the canner stand until cool before removing the cover.

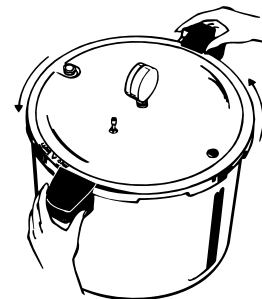

14. Lift canner cover toward you to keep steam away from you when opening.

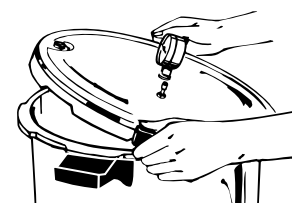

15. Remove jars from canner. Set jars apart on board or cloth away from draft to cool. When jars are cold, test seal, remove bands, wipe jars, label, date, and store in a cool, dry place.

CARE AND MAINTENANCE

1. The outside surface may be kept bright and shiny by cleaning with a good silver polish or simply by washing with soap and water. Iron and various minerals in water and foods may darken the inside of the canner but this discoloration will in no way affect food cooked. These stains may be removed by using a solution of water and cream of tartar. For each quart of water, use one tablespoon cream of tartar. Pour enough solution into the canner to cover the discoloration (do not fill over $\frac{2}{3}$ full), then close cover securely. Place regulator on vent pipe and heat until 15 pounds pressure is reached. Remove canner from heat; allow canner to stand two to three hours. Remove regulator, open canner, and empty contents. Scour thoroughly with a soap impregnated steel wool cleaning pad; wash, rinse, and dry.

Due to the acidic nature of the water supply in some areas, deterioration of the interior surface of the canner body may occur. To minimize this effect, thoroughly scour the inside of the canner body with an abrasive cleanser at least once a year.

- Each time the canner is washed, remove the sealing ring and wash in warm, sudsy water, rinse, dry, and replace in cover.
- The air vent/cover lock may be removed for occasional cleaning or for replacing the small gasket (see page 4). Wash all parts in warm, sudsy water. Use a soft cloth or small nylon brush to clean the cover hole. The small gasket must be in place when reassembling the air vent/cover lock.
- The overpressure plug can be removed for cleaning by pushing it out of its opening from the top of the cover. After cleaning, reinsert the plug by pushing the domed side of the plug into the opening from the underside of the cover, until the bottom edge is fully and evenly seated against the underside of the cover. When the overpressure plug is properly installed, the word (TOP) will be visible on the overpressure plug when viewing the outside of the cover.

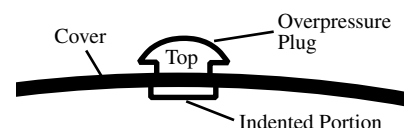

If the overpressure plug is ever forced out of its cover opening due to excess pressure while cooking or canning, it is important to call the Test Kitchen at 1-800-368-2194. **Do not attempt to use the released overpressure plug.**

5. Pouring water into a dry overheated canner may crack the metal.
6. Do not strike the rim of the canner body with any cooking utensil as this will cause nicks which may damage the rim and allow steam to escape.
7. When your pressure canner is not in use, invert the cover on the canner body and store in a dry place. Storing the canner with the cover locked on may cause unpleasant odors and deform the sealing ring.
8. **To ensure safe operation and satisfactory performance**, replace the overpressure plug every time you replace the sealing ring or sooner if it becomes hard, deformed, cracked, worn, or pitted. Replace the sealing ring and overpressure plug at least every three years. Failure to follow these instructions could result in bodily injury or property damage.
9. If the canner body or cover handles become loose, tighten with a screwdriver.
10. If leakage of moisture or steam develops while using your canner, check the following possible causes:
 - ◆ The formation of a small amount of moisture under the pressure regulator is normal when cooking or canning first begins. This condensation is a result of the temperature of the pressure regulator being lower than the rest of the canner. If excess condensation continues, the vent pipe may be loose and should be tightened with an adjustable wrench.
 - ◆ Leakage between the cover and body is usually caused by shrinkage of the sealing ring after prolonged use. Replace the sealing ring and overpressure plug.
 - ◆ A slight amount of leakage around the air vent/cover lock is normal when canning or cooking first begins. If leakage continues, the cover handles may not be fully aligned with the body handles and, therefore, the cover lock cannot engage (see page 5). Clean the air vent/cover lock occasionally to assure that it operates correctly (see page 4). Replace the small gasket if cracked or nicked.
 - ◆ A small amount of steam or moisture may be visible around the overpressure plug as canning or cooking begins. This will stop when the overpressure plug seals. If leakage continues, clean or replace the overpressure plug (see page 7).

Do not operate your pressure canner with continual leakage. If the preceding steps do not correct the problem, return the entire unit to the Presto Factory Service Department (see page 37).

11. The dial gauge is a delicate instrument which must be handled with care. Do not submerge cover or let gauge come in contact with any liquid. The pressure dial gauge needs to be checked for accuracy prior to each canning season and if any of the following conditions exist: cover has been submerged in water or dropped, gauge glass is broken or has fallen out, parts are rusty, pointer is not in the "0" block, or if you believe the gauge may not be accurate. The gauge can usually be checked at your local county extension office. If you are unable to have your dial gauge checked locally, carefully remove the gauge and send it to the Presto Consumer Service Department. See Service Information on page 37. An accurate gauge is necessary to help prevent food spoilage and possible food poisoning.
12. If the pressure canner becomes difficult to open or close, replace the sealing ring.
13. **IMPORTANT:** The sealing ring, overpressure plug, and rubber gasket of the air vent/cover lock may shrink, become hard, deformed, cracked, worn, or pitted with normal use. Exposure to high heat, such as a warm burner or oven top, will cause these parts to deteriorate rapidly. When this happens, replace the sealing ring, overpressure plug, and small rubber gasket of the air vent/cover lock. Replace the sealing ring and overpressure plug at least every three years.

Before inserting a new sealing ring, clean the sealing ring groove with a brush. To insure safe operation of your pressure canner, it is recommended that the overpressure plug be replaced whenever the sealing ring is replaced.

Any maintenance required for this product, other than normal household care and cleaning, should be performed by the Presto Factory Service Department (see page 37).

PRESSURE CANNING FRUITS AND TOMATOES

Fruits and tomatoes may be processed using pressure canning or boiling water canning. The pressure processing method for fruits and tomatoes gives a heat treatment equivalent to the much longer processing time required with the boiling water canning method.

Select firm, fully-ripened but not soft fruit or tomatoes. Do not can overripe foods. Some fruits tend to darken while they are being prepared. To prevent the darkening, place fruit in an ascorbic acid solution (1 teaspoon ascorbic acid to 1 gallon water) or use ascorbic acid or citric acid mixtures according to package instructions.

Although fruit has better color, shape, and flavor when it is canned with sugar, it may be canned unsweetened if desired. White sugar is preferable to brown sugar for canning. Light corn syrup or honey may be used to replace up to one-half the sugar.

The amount of sugar desirable to use in preparing syrups will depend upon the tartness of the fruit and on family preference. It should be remembered that fruit, when heated, releases some of its juices which will dilute the syrup in proportion to the juiciness of the fruit.

SYRUPS FOR CANNING FRUITS

<u>SYRUP</u>	<u>SUGAR PER QUART OF LIQUID</u>	<u>YIELD OF SYRUP</u>
Very Light	1 cup	4½ cups
Light	2 cups	5 cups
Medium	3 cups	5½ cups
Heavy	4¾ cups	6½ cups

Heat sugar with water or juice until sugar is dissolved. Add fruit and cook until heated through. Pack fruit into clean Mason jars to within ½-inch of top of jar. Cover with hot liquid leaving ½-inch headspace. The liquid may be syrup, fruit juice, or plain water. For steps on boiling water canning, refer to page 19.

When pressure canning at altitudes of 2,000 feet or below or boiling water canning at altitudes of 1,000 feet or below, process according to specific recipe. When canning at higher altitudes, process according to the following charts.

Altitude chart for pressure canning fruit

<u>Altitude</u>	<u>Pints and Quarts</u>
2,001 – 4,000 ft.	7 lbs.
4,001 – 6,000 ft.	8 lbs.
6,001 – 8,000 ft.	9 lbs.

Altitude chart for pressure canning tomato recipes

<u>Altitude</u>	<u>Pints and Quarts</u>
2,001 – 4,000 ft.	7 lbs. OR 12 lbs.
4,001 – 6,000 ft.	8 lbs. OR 13 lbs.
6,001 – 8,000 ft.	9 lbs. OR 14 lbs.

Processing time is the same at all altitudes.

Altitude chart for boiling water canning fruit and tomato recipes

<u>Altitude</u>	<u>Pints</u>
1,001 – 3,000 ft.	increase processing time 5 minutes
3,001 – 6,000 ft.	increase processing time 10 minutes
6,001 – 8,000 ft.	increase processing time 15 minutes

CANNING RECIPES: FRUITS AND TOMATOES

APPLES

Wash, peel, and cut apples into pieces. Place apples in an ascorbic acid solution (1 teaspoon ascorbic acid to 1 gallon water) to prevent darkening during preparation. Drain well. Boil apples in a light syrup or water for 5 minutes. Pack hot apples in clean, hot Mason jars, leaving ½-inch headspace. Cover apples with hot syrup or water, leaving ½-inch headspace. Adjust jar lids.

Pressure canning: Process at 6 pounds pressure, pints and quarts 8 minutes. For processing above 2,000 feet altitude, see chart above for recommended pounds of pressure.

Boiling water canning: Process pints and quarts 20 minutes. For processing above 1,000 feet altitude, see chart above for recommended time.

APPLESAUCE

Wash, peel, and core apples. If desired, slice apples into ascorbic acid solution (1 teaspoon ascorbic acid to 1 gallon water) to prevent darkening. Drain well. Place slices in a pan. Add ½ cup water. Cook until apples are tender. Press through food mill or sieve. Sweeten to taste. Reheat sauce to boiling. Pack into clean, hot Mason jars, leaving ½-inch headspace. Adjust jar lids.

Pressure canning: Process at 6 pounds pressure, pints 8 minutes and quarts 10 minutes. For processing above 2,000 feet altitude, see chart above for recommended pounds of pressure.

Boiling water canning: Process pints 15 minutes and quarts 20 minutes. For processing above 1,000 feet altitude, see chart above for recommended time.

APRICOTS

Wash well-ripened, firm apricots. If peeled apricots are desired, dip 1 minute in boiling water, then in cold water, and peel. Cut apricots in halves and remove pits. Place apricots in an ascorbic acid solution (1 teaspoon ascorbic acid to 1 gallon water) to prevent darkening during preparation. Drain well. Heat apricots through in a very light, light, or medium syrup or water (see page 9). Pack hot apricots, cut side down, in clean, hot Mason jars, leaving ½-inch headspace. Cover with boiling syrup or water, leaving ½-inch headspace. Adjust jar lids.

Pressure canning: Process at 6 pounds pressure, pints and quarts 10 minutes. For processing above 2,000 feet altitude, see page 9 for recommended pounds of pressure.

Boiling water canning: Process pints 20 minutes and quarts 25 minutes. For processing above 1,000 feet altitude, see page 9 for recommended time.

BERRIES (EXCEPT STRAWBERRIES)

Wash firm berries carefully, removing caps and stems. Heat berries in boiling water for 30 seconds and drain. Pack hot berries in clean, hot Mason jars, leaving ½-inch headspace. Cover with boiling syrup or water, leaving ½-inch headspace. Adjust jar lids.

Pressure canning: Process at 6 pounds pressure, pints and quarts 8 minutes. For processing above 2,000 feet altitude, see page 9 for recommended pounds of pressure.

Boiling water canning: Process pints and quarts 15 minutes. For processing above 1,000 feet altitude, see page 9 for recommended time.

CHERRIES

Wash cherries and remove stems. Remove pits, if desired. If canning whole cherries, prick each cherry with a clean needle to prevent splitting. Heat cherries with ½ cup water or syrup to each quart of cherries. Cover pan and bring to a boil. Pack hot cherries and cooking liquid in clean, hot Mason jars, leaving ½-inch headspace. Adjust jar lids.

Pressure canning: Process at 6 pounds pressure, pints 8 minutes and quarts 10 minutes. For processing above 2,000 feet altitude, see page 9 for recommended pounds of pressure.

Boiling water canning: Process pints 15 minutes and quarts 20 minutes. For processing above 1,000 feet altitude, see page 9 for recommended time.

PEACHES

Wash fully-ripened but not soft peaches. Loosen skins by dipping peaches 1 minute in boiling water, then in cold water. Peel. Cut peaches in half and remove pits. Slice if desired. Place peaches in an ascorbic acid solution (1 teaspoon ascorbic acid to 1 gallon water) to prevent darkening during preparation. Drain well. Heat peaches through in very light, light, or medium syrup or water (see page 9). Pack hot peaches, cut side down, in clean, hot Mason jars, leaving ½-inch headspace. Cover with boiling syrup or water, leaving ½-inch headspace. Adjust jar lids.

Pressure canning: Process at 6 pounds pressure, pints and quarts 10 minutes. For processing above 2,000 feet altitude, see page 9 for recommended pounds of pressure.

Boiling water canning: Process pints 20 minutes and quarts 25 minutes. For processing above 1,000 feet altitude, see page 9 for recommended time.

PEARS

Wash pears. Peel, cut in half lengthwise, and core. Slice pears, if desired. Place pears in an ascorbic acid solution (1 teaspoon ascorbic acid to 1 gallon water) to prevent darkening during preparation. Drain well. Boil pears 5 minutes in very light, light, or medium syrup or water (see page 9). Pack hot pears in clean, hot Mason jars, leaving ½-inch headspace. Cover with boiling syrup or water, leaving ½-inch headspace. Adjust jar lids.

Pressure canning: Process at 6 pounds pressure, pints and quarts 10 minutes. For processing above 2,000 feet altitude, see page 9 for recommended pounds of pressure.

Boiling water canning: Process pints 20 minutes and quarts 25 minutes. For processing above 1,000 feet altitude, see page 9 for recommended time.

PLUMS

Wash firm ripe plums. Remove stems. If plums are to be canned whole, prick each side with a fork. Freestone varieties may be cut in halves and pitted. Heat plums to boiling in very light, light, or medium syrup (see page 9). Boil 2 minutes. Cover saucepan and let stand 20 to 30 minutes. Pack hot plums in clean, hot Mason jars, leaving ½-inch headspace. Cover with boiling syrup or water, leaving ½-inch headspace. Adjust jar lids.

Pressure canning: Process at 6 pounds pressure, pints and quarts 10 minutes. For processing above 2,000 feet altitude, see page 9 for recommended pounds of pressure.

Boiling water canning: Process pints 20 minutes and quarts 25 minutes. For processing above 1,000 feet altitude, see page 9 for recommended time.

RHUBARB

Wash young, tender rhubarb. Remove ends and cut into ½-inch pieces. Add ½ cup sugar to each quart of rhubarb. Let stand until juice appears. Heat rhubarb slowly to boiling. Pack hot rhubarb in clean, hot Mason jars, leaving ½-inch headspace. Adjust jar lids.

Pressure canning: Process at 6 pounds pressure, pints and quarts 8 minutes. For processing above 2,000 feet altitude, see page 9 for recommended pounds of pressure.

Boiling water canning: Process pints and quarts 15 minutes. For processing above 1,000 feet altitude, see page 9 for recommended time.

TOMATOES—WHOLE OR HALVED (packed raw without added liquid)

Wash medium, smooth, firm, ripe tomatoes. Loosen skins by dipping tomatoes 1 minute in boiling water, then in cold water. Peel and remove core. Leave whole or halve. Add 2 tablespoons of bottled lemon juice or ½ teaspoon of citric acid per quart of tomatoes. For pints, use 1 tablespoon bottled lemon juice or ¼ teaspoon citric acid. Add 1 teaspoon salt to each quart, ½ teaspoon to each pint, if desired. Fill jars with raw tomatoes, pressing until spaces between them fill with juice. Leave ½-inch headspace. Adjust jar lids.

Pressure canning: Process at 6 pounds pressure, pints and quarts 40 minutes **OR** process at 11 pounds pressure, pints and quarts 25 minutes. For processing above 2,000 feet altitude, see page 9 for recommended pounds of pressure.

Boiling water canning: Process pints and quarts 85 minutes. For processing above 1,000 feet altitude, see page 9 for recommended time.

TOMATO JUICE

Wash ripe, juicy tomatoes. Remove stem ends and cut into pieces. To prevent juice from separating, quickly cut about 1 pound of fruit into quarters and put directly into saucepan. Heat immediately to boiling while crushing. Continue to slowly add and crush freshly cut tomato quarters to the boiling mixture. Make sure the mixture boils constantly and vigorously while adding the remaining tomatoes. Simmer 5 minutes after all pieces are added. If juice separation is not a concern, simply slice or quarter tomatoes into a large saucepan. Crush, heat, and simmer for 5 minutes before juicing.

Press heated juice through a sieve or food mill to remove skins and seeds.

Add 2 tablespoons of bottled lemon juice or ½ teaspoon citric acid to each quart. Add 1 tablespoon of bottled lemon juice or ¼ teaspoon citric acid to each pint.

Heat juice again to boiling. Add 1 teaspoon of salt to each quart, ½ teaspoon to each pint, if desired. Fill jars with hot tomato juice, leaving ½-inch headspace. Adjust jar lids.

Pressure canning: Process at 6 pounds pressure, pints and quarts 20 minutes **OR** process at 11 pounds pressure, pints and quarts 15 minutes. For processing above 2,000 feet altitude, see page 9 for recommended pounds of pressure.

Boiling water canning: Process pints 35 minutes and quarts 40 minutes. For processing above 1,000 feet altitude, see page 9 for recommended time.

TOMATO SAUCE

Prepare and press as for making tomato juice (see recipe above). Heat in large saucepan until sauce reaches desired consistency. Simmer until volume is reduced by about one-third for thin sauce, or by one-half for thick sauce. Add 2 tablespoons of bottled lemon juice or ½ teaspoon of citric acid to each quart. Add 1 tablespoon of bottled lemon juice or ¼ teaspoon citric acid to each pint. Pour hot sauce in clean, hot Mason jars, leaving ½-inch headspace. Adjust jar lids.

Pressure canning: Process at 6 pounds pressure, pints and quarts 20 minutes **OR** process at 11 pounds pressure, pints and quarts 15 minutes. For processing above 2,000 feet altitude, see page 9 for recommended pounds of pressure.

Boiling water canning: Process pints 35 minutes and quarts 40 minutes. For processing above 1,000 feet altitude, see page 9 for recommended time.

SALSA

Process salsa using the boiling water method. Refer to page 21 for tested canning recipe.

PRESSURE CANNING VEGETABLES

Pressure canning is the only safe method for canning vegetables.

Young, tender, fresh vegetables, slightly immature, are better for canning than those which are overripe. As a rule, vegetables are best if canned immediately after picking, since flavor decreases upon standing and often unpleasant color changes take place. Avoid bruising vegetables because spoilage organisms grow more rapidly on bruised vegetables than on unblemished ones.

Wash and prepare garden fresh vegetables as you would for cooking.

To raw pack vegetables, simply place the prepared vegetables into clean, hot Mason jars and cover with boiling water.

To hot pack vegetables, precook in boiling water until heated through. Pack pre-cooked vegetables into clean, hot Mason jars and cover with boiling water. Whenever possible, the precooking water should be used as liquid to cover the vegetables after packing into Mason jars. However, there are a few vegetables, such as greens and asparagus, which make the cooking water bitter and undesirable to use.

When packing vegetables, leave 1-inch headspace in Mason jars.

Foods may be processed with or without salt. If salt is desired, use only canning salt. Table salt contains a filler which may cause cloudiness in bottom of jars. Add ½ teaspoon canning salt to each pint jar, 1 teaspoon to each quart jar, if desired.

Follow step-by-step directions beginning on page 6 for canning procedure. Process specific vegetables according to the following recipes.

When pressure canning at altitudes of 2,000 feet or below, process according to specific recipe. When canning at higher altitudes, process according to the following chart.

Altitude chart for canning vegetables

<u>Altitude</u>	<u>Pints and Quarts</u>	
2,001 – 4,000 ft.	12 lbs.	12 lbs.
4,001 – 6,000 ft.	13 lbs.	13 lbs.
6,001 – 8,000 ft.	14 lbs.	14 lbs.

Processing time is the same at all altitudes.

CANNING RECIPES: VEGETABLES

ASPARAGUS

Wash and drain asparagus. Remove tough ends and scales. Rinse. Leave asparagus whole or cut into pieces.

Raw Pack: Pack raw asparagus tightly in clean, hot Mason jars, leaving 1-inch headspace.

Hot Pack: Cover asparagus with boiling water and boil 2 or 3 minutes. Pack hot asparagus loosely in clean, hot Mason jars, leaving 1-inch headspace.

Cover with boiling water, leaving 1-inch headspace. Adjust jar lids.

Process at 11 pounds pressure – Pints 30 minutes and Quarts 40 minutes. For processing above 2,000 feet altitude, see chart above for recommended pounds of pressure.

BEANS OR PEAS—DRY

Sort out and discard any discolored seeds. Rehydrate beans or peas using one of the following methods:

- ❖ Place dry beans or peas in a large pot and cover with water. Soak 12 to 18 hours in a cool place. Then drain.
- ❖ Cover beans with boiling water in a saucepan. Boil 2 minutes, remove from heat and soak 1 hour. Then drain.

Cover beans soaked by either method with fresh water and boil 30 minutes.

Hot Pack: Fill clean, hot Mason jars with beans or peas and cooking water, leaving 1-inch headspace. Adjust jar lids.

Process at 11 pounds of pressure – Pints 75 minutes and Quarts 90 minutes. For processing above 2,000 feet altitude, see chart above for recommended pounds of pressure.

BEANS—GREEN, WAX, ITALIAN

Wash young, tender beans thoroughly. Remove stem and blossom ends or any “strings”. Leave whole or cut into 1-inch pieces.

Raw Pack: Pack raw beans tightly in clean, hot Mason jars leaving 1-inch head space.

Hot Pack: Cover beans with boiling water and boil 5 minutes. Pack hot beans loosely in clean, hot Mason jars, leaving 1-inch head space.

Cover with boiling water, leaving 1-inch headspace. Adjust jar lids.

Process at 11 pounds pressure – Pints 20 minutes and Quarts 25 minutes. For processing above 2,000 feet altitude, see page 12 for recommended pounds of pressure.

BEANS—FRESH LIMA

Shell and wash young, tender beans thoroughly.

Raw Pack: Pack raw lima beans loosely in clean, hot Mason jars, leaving 1-inch headspace in pint jars. For quarts, leave 1½-inches headspace if beans are small; and 1¼-inches headspace if beans are large.

Hot Pack: Cover beans with boiling water and bring to a boil. Boil 3 minutes. Pack hot beans loosely in clean, hot Mason jars, leaving 1-inch headspace.

Cover with boiling water, leaving 1-inch headspace. Adjust jar lids.

Process at 11 pounds pressure – Pints 40 minutes and Quarts 50 minutes. For processing above 2,000 feet altitude, see page 12 for recommended pounds of pressure.

BEETS

Trim tops of young, tender beets, leaving 1 inch of stem and roots to reduce bleeding of color. Wash thoroughly. Cover with boiling water and boil 15 to 25 minutes or until skins slip off easily. Remove skins, stems, and roots. Small beets may be left whole. Cut medium or large beets into ½-inch cubes or slices; halve or quarter very large slices. Pack hot beets in clean, hot Mason jars, leaving 1-inch headspace. Cover with boiling water, leaving 1-inch headspace. Adjust jar lids.

Process at 11 pounds pressure – Pints 30 minutes and Quarts 35 minutes. For processing above 2,000 feet altitude, see page 12 for recommended pounds of pressure.

CARROTS

Wash thoroughly and scrape young, tender carrots. Carrots may be left whole, sliced, or diced.

Raw Pack: Pack raw carrots tightly in clean, hot Mason jars, leaving 1-inch headspace.

Hot Pack: Cover carrots with boiling water, bring to a boil and simmer 5 minutes. Pack hot carrots in clean, hot Mason jars, leaving 1-inch headspace.

Cover with boiling water leaving 1-inch headspace. Adjust jar lids.

Process at 11 pounds pressure – Pints 25 minutes and Quarts 30 minutes. For processing above 2,000 feet altitude, see page 12 for recommended pounds of pressure.

CORN—WHOLE KERNEL

Husk and remove silk from young, tender, freshly picked corn; wash ears. Blanch 3 minutes in boiling water. Cut corn from cob at about ¾ the depth of the kernel. Do not scrape cob.

Raw Pack: Pack raw corn loosely in clean, hot Mason jars, leaving 1-inch headspace.

Hot Pack: To each quart of corn add 1 cup boiling water; heat to boiling and simmer 5 minutes. Pack hot corn loosely in clean, hot Mason jars, leaving 1-inch headspace.

Cover with boiling water leaving 1-inch headspace. Adjust jar lids.

Process at 11 pounds pressure – Pints 55 minutes and Quarts 85 minutes. For processing above 2,000 feet altitude, see page 12 for recommended pounds of pressure.

GREENS

Sort young, tender, freshly picked greens discarding wilted tough leaves, stems, and roots. Wash greens thoroughly. Do not raw pack greens. Place approximately 1 pound of greens at a time in a cheese cloth bag and steam 3 to 5 minutes or until well wilted. Pack hot greens loosely in clean, hot Mason jars, leaving 1-inch headspace. Cover with fresh boiling water, leaving 1-inch headspace. Adjust jar lids.

Process at 11 pounds pressure – Pints 70 minutes and Quarts 90 minutes. For processing above 2,000 feet altitude, see page 12 for recommended pounds of pressure.

MUSHROOMS

Trim stems and discolored parts of mushrooms. Soak mushrooms in cold water for 10 minutes to remove soil. Wash in clean water. Leave small mushrooms whole; cut larger ones in halves or quarters. Cover with water in a saucepan and boil 5 minutes. Pack hot mushrooms in clean, hot Mason jars, leaving 1-inch headspace. For better color, add 1/8 teaspoon of ascorbic acid per pint. Cover with boiling water, leaving 1-inch headspace. Adjust jar lids.

Process at 11 pounds pressure – Half pints and Pints 45 minutes. For processing above 2,000 feet altitude, see page 12 for recommended pounds of pressure.

OKRA

Wash and trim young, tender okra pods. Remove stem, without cutting into pods if okra is to be canned whole. If desired, slice okra into 1-inch pieces. Cover okra with boiling water and boil 2 minutes. Pack hot okra in clean, hot Mason jars, leaving 1-inch headspace. Cover with boiling water, leaving 1-inch headspace. Adjust jar lids.

Process at 11 pounds pressure – Pints 25 minutes and Quarts 40 minutes. For processing above 2,000 feet altitude, see page 12 for recommended pounds of pressure.

PEAS—GREEN

Wash and shell young, tender freshly picked green peas. Rinse.

Raw Pack: Pack peas loosely in clean, hot Mason jars, leaving 1-inch headspace. Do not shake or press down.

Hot Pack: Cover peas with boiling water and bring to a boil. Boil 2 minutes. Pack hot peas loosely in clean, hot Mason jars, leaving 1-inch headspace. Do not shake or press down.

Cover with boiling water, leaving 1-inch headspace. Adjust jar lids.

Process at 11 pounds pressure – Pints and Quarts 40 minutes. For processing above 2,000 feet altitude, see page 12 for recommended pounds of pressure.

PEPPERS—HOT OR SWEET

(including bell, chile, jalapeño and pimiento)

Preparation of Chile peppers—Cut two or four slits in each pepper, and blister using one of the following methods:

- ❖ Oven or broiler method: Place chile peppers in a 400° oven or broiler for 6 to 8 minutes until skins blister.
- ❖ Range-top method: Cover hot burner, either gas or electric with heavy wire mesh. Place chilies on burner for several minutes until skins blister.

Allow peppers to cool. Place in a pan and cover with a damp cloth. After several minutes, peel peppers. Remove stems and seeds.

Preparation of other peppers—Remove stems and seeds; blanch 3 minutes.

Hot Pack: Small peppers may be left whole. Large peppers may be quartered. Pack peppers loosely in clean, hot Mason jars, leaving 1-inch headspace. Cover with boiling water, leaving 1-inch headspace. Adjust jar lids.

Process at 11 pounds of pressure – Pints 35 minutes. For processing above 2,000 feet altitude, see page 12 for recommended pounds of pressure.

POTATOES—SWEET

Wash sweet potatoes. Boil or steam just until partially soft (15 to 20 minutes). Remove skins and cut into pieces. CAUTION: Do not mash or puree potatoes. Pack hot sweet potatoes in clean, hot Mason jars, leaving 1-inch headspace. Cover with boiling water, leaving 1-inch headspace. Adjust jar lids.

Process at 11 pounds pressure – Pints 65 minutes and Quarts 90 minutes. For processing above 2,000 feet altitude, see page 12 for recommended pounds of pressure.

POTATOES—WHITE

Wash, scrape, and rinse new potatoes 1 to 2½ inches in diameter. If desired, cut into ½-inch cubes. Place in ascorbic acid solution (1 teaspoon ascorbic acid to 1 gallon water) to prevent darkening. Drain. Cover potatoes with hot water; bring to a boil and boil whole potatoes for 10 minutes, cubes for 2 minutes. Pack hot potatoes in clean, hot Mason jars, leaving 1-inch headspace. Cover with boiling water, leaving 1-inch headspace. Adjust jar lids.

Process at 11 pounds pressure – Pints 35 minutes and Quarts 40 minutes. For processing above 2,000 feet altitude, see page 12 for recommended pounds of pressure.

PUMPKIN AND WINTER SQUASH

Wash and remove seeds. Cut into 1-inch slices and peel. Cut flesh into 1-inch cubes. Boil 2 minutes in water. CAUTION: Do not mash or puree. Pack hot squash cubes loosely in clean, hot Mason jars, leaving 1-inch headspace. Cover with boiling water, leaving 1-inch headspace. Adjust jar lids.

Process at 11 pounds pressure – Pints 55 and Quarts 90 minutes. For processing above 2,000 feet altitude, see page 12 for recommended pounds of pressure.

PRESSURE CANNING MEAT

Pressure canning is the only safe method for canning meat.

All meat should be handled carefully to avoid contamination from the time of slaughtering until the products are canned. Animals should be correctly slaughtered, canned promptly or kept under refrigeration until processed. If you slaughter your own meat, contact your local county agricultural agent for complete information on slaughtering, chilling, and aging the meat.

Keep meat as cool as possible during preparation for canning, handle rapidly and process meat as soon as it is packed. Most meats need only be wiped with a damp cloth. Use lean meat for canning; remove most of the fat. Cut off gristle and remove large bones. Cut into pieces convenient for canning.

To prepare broth, place bony pieces in saucepan and cover with cold water. Simmer until meat is tender. Discard fat. Add boiling broth to jars packed with precooked meat and poultry.

Meat should not be browned with flour nor should flour be used in the broth to make gravy for pouring over the packed meat. Pack hot meat loosely, leaving 1-inch headspace in Mason jars.

Meats may be processed with or without salt. If salt is desired, use only canning salt. Table salt contains a filler which may cause cloudiness in bottom of jar. Use ½ teaspoon salt to each pint, 1 teaspoon to each quart. More or less salt may be added to suit individual taste.

Follow step-by-step directions beginning on page 6 for canning procedure. Process meats according to the following recipes.

When pressure canning at altitudes of 2,000 feet or below, process according to specific recipe. When canning at higher altitudes, process according to the following charts.

Altitude chart for canning meat, poultry, fish, seafood, and soup

<u>Altitude</u>	<u>Pints and Quarts</u>	
2,001 – 4,000 ft.	12 lbs.	12 lbs.
4,001 – 6,000 ft.	13 lbs.	13 lbs.
6,001 – 8,000 ft.	14 lbs.	14 lbs.

Processing time is the same at all altitudes.

CANNING RECIPES: MEAT

CUT-UP MEAT (strips, cubes, or chunks)

Bear, Beef, Pork, Lamb, Veal, and Venison

Remove excess fat. Soak strong-flavored wild meats for 1 hour in brine water containing 1 tablespoon of salt per quart of water. Rinse. Remove large bones and cut into desired pieces.

Raw Pack: Fill jars with raw meat pieces, leaving 1-inch headspace. DO NOT ADD LIQUID. Adjust jar lids.

Hot Pack: Precook meat until rare by broiling, boiling or frying. Pack hot meat loosely in clean, hot Mason jars, leaving 1-inch headspace. Cover meat with boiling broth, water, or tomato juice (especially with wild game) leaving 1-inch headspace. Adjust jar lids.

Process at 11 pounds pressure – Pints 75 minutes and Quarts 90 minutes. For processing above 2,000 feet altitude, see the chart above for recommended pounds of pressure.

GROUND MEAT

Bear, Beef, Pork, Lamb, Veal, and Venison

With venison add one part high quality pork fat to three or four parts venison before grinding. Use freshly made sausage, seasoned with salt and cayenne pepper (sage may cause a bitter off-flavor). Add 1 teaspoon salt to each pound of ground meat if desired. Mix well. Shape meat into patties or balls or cut cased sausage into 3-to 4-inch links. Cook until lightly browned. Ground meat may be sautéed without shaping. Remove excess fat. Fill jars with pieces, leaving 1-inch headspace. Cover meat with boiling broth or water, leaving 1-inch headspace. Adjust jar lids.

Process at 11 pounds pressure – Pints 75 minutes and Quarts 90 minutes. For processing above 2,000 feet altitude, see page 15 for recommended pounds of pressure.

PRESSURE CANNING POULTRY

Pressure canning is the only safe method for canning poultry.

Cut poultry into convenient pieces for packing and precook until medium done or until pieces, when cut, show almost no pink color at the bone.

Precook by boiling in water or in a concentrated broth for more flavor. Make broth from bones and bony pieces, neck, back, and wing tips. Pack hot meat in clean, hot Mason jars, leaving 1-inch headspace. Do not pack food tightly.

Poultry may be processed with or without salt. If salt is desired, use only canning salt. Table salt contains a filler which may cause cloudiness in bottom of jar. Use ½ teaspoon salt to each pint, 1 teaspoon to each quart.

Follow step-by-step directions beginning on page 6 for canning procedure. Process poultry according to the following recipes.

CANNING RECIPES: POULTRY

CUT-UP POULTRY

Cut poultry into serving size pieces. If desired, remove bone. Boil, steam, or bake poultry slowly to medium done. Poultry is medium done when pink color in center is almost gone. Pack hot poultry loosely in clean, hot Mason jars, leaving 1¼-inch headspace. Cover poultry with boiling broth or water, leaving 1¼-inch headspace. Adjust jar lids.

Process at 11 pounds pressure	<u>With Bone</u>	<u>Without Bone</u>
Pints	65 minutes	75 minutes
Quarts	75 minutes	90 minutes

For processing above 2,000 feet altitude, see page 15 for recommended pounds of pressure.

RABBIT

Soak dressed rabbits 1 hour in water containing 1 tablespoon of salt per quart. Rinse and remove excess fat. Cut into serving size pieces. Boil, steam, or bake to medium done. Rabbit is medium done when pink color in center is almost gone. Pack hot rabbit loosely in clean, hot Mason jars, leaving 1¼ inch headspace. Cover rabbit with boiling broth or water leaving 1¼ inch headspace. Adjust jar lids.

Process at 11 pounds pressure	<u>With Bone</u>	<u>Without Bone</u>
Pints	65 minutes	75 minutes
Quarts	75 minutes	90 minutes

For processing above 2,000 feet altitude, see page 15 for recommended pounds of pressure.

PRESSURE CANNING FISH AND SEAFOOD

Pressure canning is the only safe method for canning fish and seafood.

Only fresh fish should be canned and these should be bled and thoroughly cleaned of all viscera and membranes when caught, or as soon as possible. Canning should be restricted to proven varieties where it is definitely known that a product of good quality may be obtained.

Follow step-by-step directions beginning on page 6 for canning procedure. Process fish and seafood according to the following recipes.

CANNING RECIPES: FISH AND SEAFOOD

CLAMS—WHOLE OR MINCED

Keep clams on ice until ready to can. Scrub shells thoroughly and rinse. Steam 5 minutes and open. Remove clam meat. Collect and save clam juice. Wash clam meat in salted water using 1 teaspoon of salt for each quart of water. Rinse. In a saucepan, cover clam meat with boiling water containing 2 tablespoons of lemon juice or ½ teaspoon of citric acid per gallon. Boil 2 minutes and drain. To make minced clams, grind clams with a meat grinder or food processor. Fill jars loosely with pieces leaving 1-inch headspace and add hot clam juice and boiling water if needed, leaving 1-inch headspace. Adjust jar lids.

Process at 11 pounds pressure – Half pints 60 minutes and Pints 70 minutes. For processing above 2,000 feet altitude, see page 15 for recommended pounds of pressure.

CRAB

Keep live crabs on ice until ready to can. Wash crabs thoroughly. Place crabs in water containing ¼ cup lemon juice and 2 tablespoons of salt per gallon. Simmer 20 minutes. Cool in cold water and drain. Remove back shell and then remove meat from body and claws. Soak meat 2 minutes in cold water containing 2 cups lemon juice or 4 cups of white vinegar and 2 tablespoons of salt per gallon. Drain and remove excess moisture. Pack loosely into clean, hot Mason jars, leaving 1-inch headspace. Add ½ teaspoon citric acid or 2 tablespoons lemon juice to each half-pint jar; 1 teaspoon citric acid or 4 tablespoons lemon juice per pint jar. Add hot water, leaving 1-inch headspace. Adjust jar lids.

Process at 11 pounds pressure – Half pints 70 minutes and Pints 80 minutes. For processing above 2,000 feet altitude, see page 15 for recommended pounds of pressure.

FISH—GENERAL METHOD

For all fish except tuna. Clean fish thoroughly; filet large fish or leave small pan fish whole. Cut into container length pieces. Pack with skin side of fish to the outside of the Mason jar, leaving 1-inch headspace. **DO NOT ADD LIQUIDS.** Adjust jar lids.

Process at 11 pounds pressure – Pints 100 minutes. For processing above 2,000 feet altitude, see page 15 for recommended pounds of pressure.

TUNA

Clean fish thoroughly. Place fish belly side down on a rack, in the bottom of a large baking pan. Precook fish at 350° for 1 hour. Refrigerate cooked fish overnight to firm the meat. Remove skin and backbone. Cut meat in pieces 1 inch shorter than Mason jars and pack solidly. Fill jars with hot cooking oil or boiling water, leaving 1-inch headspace. Adjust jar lids.

Process at 11 pounds pressure – Half pints and Pints 100 minutes. For processing above 2,000 feet altitude, see page 15 for recommended pounds of pressure.

PRESSURE CANNING SOUPS

Pressure canning is the only safe method for canning soups.

Soup or soup stock is quickly and easily canned. Soup should always be cooked ready for serving, then poured into clean, hot Mason jars, leaving 1-inch headspace. Generally, vegetable soups are more satisfactory if the stock and vegetable mixture is canned separately and combined at the time of serving.

Follow step-by-step directions beginning on page 6 for canning procedure. Process soups according to the following recipes.

CANNING RECIPES: SOUP

BEEF SOUP STOCK

Saw or crack fresh trimmed beef bones to enhance extraction of flavor. Rinse bones and place in a large kettle, cover bones with water and simmer 3 to 4 hours. Remove bones. Cool broth; skim off and discard fat. Remove bits of meat from bones and add to broth, if desired. Reheat broth to boiling. Fill jars, leaving 1-inch headspace. Adjust jar lids.

Process at 11 pounds pressure – Pints 20 minutes and Quarts 25 minutes. For processing above 2,000 feet altitude, see page 15 for recommended pounds of pressure.

CHICKEN SOUP STOCK

Place large carcass bones in stockpot, add enough water to cover bones. Cover and simmer 30 to 45 minutes or until meat can be easily removed from bones. Remove bones. Cool broth; skim off and discard fat. Remove bits of meat from bones and add to broth, if desired. Reheat broth to boiling. Fill jars, leaving 1-inch headspace. Adjust jar lids.

Process at 11 pounds pressure – Pints 20 minutes and Quarts 25 minutes. For processing above 2,000 feet altitude, see page 15 for recommended pounds of pressure.

HELPFUL HINTS FOR PRESSURE CANNING

- ❖ Bubbles often appear in the jar after it is removed from canner because food is still boiling in jar. Ordinarily bubbles do not appear once the product has been allowed to thoroughly cool.
- ❖ Jar breakage during processing is caused by: (1) Packing jar too solidly or overfilling; (2) Weakened, cracked jars; (3) Jars touching bottom of canner; (4) Lids improperly tightened; (5) Use of jars other than Mason jars.
- ❖ Liquid lost from jars during processing is caused by: (1) Packing jar too solidly or overfilling; (2) Too high a temperature or too high pressure; (3) Variation or sudden lowering of temperature in the canner. When processing food, pressure regulator should not be taken off the vent pipe and cover should not be removed until air vent/cover lock has dropped and pressure has been completely reduced; (4) Failure to adjust jar lids according to manufacturer's directions.
- ❖ The loss of liquid from jars during processing may be unattractive but it will not interfere with the keeping qualities of the food as long as the jar was processed correctly and is sealed.
- ❖ It is better to overprocess food than underprocess as overprocessing will do little harm, but underprocessing may result in spoilage and unsafe food.
- ❖ Flat sour, a type of food spoilage, is caused by canning overripe food or allowing precooked foods to stand in jar too long before processing. It may be prevented by using fresh products and properly processing, cooling, and storing. Flat sour shows no indication of spoilage until jar is opened.
- ❖ Food spoilage or jars not sealing is caused by: (1) Failure to follow exact timetables and recipes; (2) Failure to wipe sealing edge of jar clean before placing lid on jar; (3) Foods, seeds, or grease lodged between lid and jar; (4) Jars which are nicked or cracked or have sharp sealing edges; (5) Failure to adjust jar lids according to manufacturer's directions; (6) Turning jars upside down while jars are cooling and sealing.
- ❖ Mold can form only in the presence of air. Therefore, jars are not sealed if mold is present.
- ❖ The black deposit sometimes found on the underside of a lid is caused by tannins in the food or hydrogen sulfide which is liberated from the food by the heat of processing. This does not indicate spoilage.
- ❖ If a jar does not seal, use the food at once, freeze or repack using different lids. Reprocess for the full recommended processing time.

- ❖ Two-piece vacuum caps seal by the cooling of the contents of the jar, not through pressure of the screw band on the lid. Therefore, although the screw band is firmly tight, the jar is not sealed until cooled. During processing, the flexible metal lid permits air to be exhausted from the jar.
- ❖ Adjust two-piece vacuum caps by screwing bands down evenly and firmly until a point of resistance is met—fingertip tight. Do not use undue exertion.
- ❖ It is not necessary for the liquid on canned meats to congeal. The liquid will congeal only when there is a large amount of gelatin from cartilage or connective tissue present.
- ❖ The loss of color from beets, during canning, is usually due to the variety of beets used or beets that are too old. If possible, can young, tender, very dark beets which are freshly gathered. Precook beets with 2 inches of the stem and all of the root on, as this helps to retain the juices.
- ❖ Discoloration of peaches and pears on the top of the jar is often due to enzyme activity which means that the processing time was not long enough or the temperature not high enough to render enzymes inactive
- ❖ Fruit which has been canned without sugar will often turn brown when exposed to air just as fresh fruit does.
- ❖ The diameter of Mason jars may vary from one manufacturer to another. Before filling Mason jars, test load your canner. It may be necessary to double-deck pint and ½ pint jars to reach the maximum capacity of your canner as shown in the chart on page 6. It is recommended that you stagger the jars by placing one jar on top of two. Jars may touch. The canning rack which accompanied your Pressure Canner/Cooker must be placed on the bottom of the canner to prevent jar breakage. Although it is not necessary to use a rack between layers of jars, if you wish to do so, a rack can be ordered from the Presto Consumer Service Department. See page 37 for address.

HOW TO CAN FOODS USING BOILING WATER METHOD

Note: Your 16-quart canner can be used as a boiling water canner for ½ pint and pint jars only. It is not tall enough to allow adequate space for quart jars.

1. Place cooking/canning rack on bottom of canner. Fill canner halfway with water.
2. Preheat water to 140°F for raw-packed foods and to 180°F for hot-packed foods.
3. Remove overpressure plug and pressure regulator from canner cover and set aside.
4. Use jar lifter to place filled jars, with lids and rings fastened according to manufacturer's directions, on cooking/canning rack in canner.
5. Check water level. Add more boiling water, if needed, so the water level is at least 1 inch above jar tops.
6. Turn heat to its highest setting until water boils vigorously.
7. Look through the vent pipe on the canner cover to be certain it is open before placing cover on canner. To clean the vent pipe, draw a pipe cleaner or small brush through the opening.
8. Place cover on canner, aligning the **V** mark on the cover with the **A** mark on the body handle and lock securely by turning in the direction indicated to close the cover (clockwise). **Cover handles must be centered over body handles. Do not force beyond this position.**
9. Set a timer for the minutes required for processing the food based on tested canning recipe.
10. Lower the heat setting to maintain a gentle boil throughout processing.
11. Add more boiling water, if needed, to keep the water level above the jars.
12. When jars have been boiled for the recommended time, turn off the heat and remove the canner cover.
13. Using jar lifter, remove jars and place them on a towel, leaving at least 1-inch spaces between jars during cooling.

CANNING RECIPES: BOILING WATER METHOD

The following recipes are safely canned by the boiling water method. Do not pressure can these recipes because the food quality would be unacceptable.

APPLE BUTTER

16 medium apples (about 4 pounds)	2 teaspoons cinnamon
4 cups sugar	¼ teaspoon cloves

To prepare pulp: Wash apples; remove stem and blossom ends; do not peel or core. Cut apples into small pieces. Add 2 cups water; cover; simmer 20 to 25 minutes or until apples are soft. Press through a sieve or food mill. Measure 2 quarts apple pulp.

To prepare butter: Combine apple pulp, sugar, and spices in a large saucepot. Cook slowly until thick enough to round up on a spoon. As pulp thickens, stir frequently to prevent sticking. (If too thick, add a small amount of water or apple juice for desired consistency.) Ladle hot butter into hot jars, leaving ¼-inch headspace. Adjust two-piece caps. Process 10 minutes using boiling water canning method described on page 19. Yield: about 5 pints.

RASPBERRY JAM

2 quarts raspberries	1 tablespoon lemon juice
1 package powdered pectin	1 tablespoon grated lemon peel
⅓ cup water	6 cups sugar

Combine raspberries, pectin, water, lemon juice, and lemon peel in a large saucepot. Bring to a boil over high heat, stirring frequently. Add sugar, stirring until dissolved. Return to a rolling boil. Boil hard 1 minute, stirring constantly. Remove from heat. Skim foam, if necessary. Ladle hot jam into hot jars, leaving ¼-inch headspace. Adjust two-piece caps. Process 10 minutes using boiling water canning method described on page 19. Yield: about 5 half-pints.

BREAD AND BUTTER PICKLES

4 pounds 4- to 6-inch cucumbers, cut into slices	2 tablespoons mustard seed
2 pounds onions, thinly sliced (about 8 small)	2 teaspoons turmeric
⅓ cup canning salt	2 teaspoons celery seed
2 cups sugar	1 teaspoon ginger
	1 teaspoon peppercorns
	3 cups vinegar, 5% acidity

Combine cucumber and onion slices in a large bowl. Layer vegetables with salt; cover with ice cubes. Let stand 1½ hours. Drain; rinse. Combine remaining ingredients in a large saucepot; bring to a boil. Add drained cucumbers and onions and return to a boil. Pack hot pickles and liquid into hot jars, leaving ¼-inch headspace. Remove air bubbles. Adjust two-piece caps. Process 10 minutes using boiling water canning method described on page 19. Yield: about 7 pints.

Note: For fresh pack pickled foods, allow 4 to 6 weeks for the product to cure and develop a satisfactory flavor.

DILL PICKLES

8 pounds 4- to 6-inch cucumbers, cut lengthwise into halves	1 quart vinegar, 5% acidity
¾ cup sugar	1 quart water
½ cup canning salt	3 tablespoons mixed pickling spices
	Green or dry dill (1 head per jar)

Wash and drain cucumbers. Combine sugar, salt, vinegar, and water in a large saucepot. Tie spices in a spice bag; add spice bag to vinegar mixture; simmer 15 minutes. Pack cucumbers into hot jars, leaving ¼-inch headspace; put one head of dill in each jar. Ladle hot liquid over cucumbers, leaving ¼-inch headspace. Remove air bubbles. Adjust two-piece caps. Process pints 15 minutes using boiling water canning method described on page 19. Yield: about 7 pints.

Note: For fresh pack pickled foods, allow 4 to 6 weeks for the product to cure and develop a satisfactory flavor.

ZESTY SALSA

10 cups chopped, seeded, peeled, cored tomatoes (about 6 pounds)	2½ cups chopped and seeded hot peppers (about 1 pound)
5 cups chopped and seeded long green peppers (about 2 pounds)	1¼ cups cider vinegar
5 cups chopped onions (about 1½ pounds)	3 cloves garlic, minced
	2 tablespoons cilantro, minced
	1 tablespoon salt
	1 teaspoon hot pepper sauce (optional)

Combine all ingredients in a large saucepot, adding hot pepper sauce, if desired. Bring mixture to a boil. Reduce heat and simmer 10 minutes. Ladle hot salsa into hot jars, leaving ¼-inch headspace. Adjust two-piece caps. Process 15 minutes using boiling water canning method described on page 19. Yield: about 6 pints.

Note: When cutting or seeding hot peppers, wear rubber gloves to prevent hands from being burned.

For boiling water canning information for fruits and tomatoes, refer to page 8.

For additional information and recipes, consult the Ball Blue Book or visit www.homecanning.com.

Recipes provided by Alltrista Consumer Products Company, marketers of Ball® and Kerr® home canning products.

PRESSURE COOKING IN YOUR PRESSURE CANNER

Follow the step-by-step instructions (see “How To Pressure Cook Foods” below) for cooking in your pressure canner. Prepare food according to directions in specific recipe.

The canner should never be filled over ⅔ full. Many foods tend to expand when cooked. If the canner is filled over ⅔ full, it is possible for food to expand enough to plug the vent pipe, air vent/cover lock, and overpressure plug. If all of these devices were to become blocked, excess pressure would be unable to escape and would build up beyond safe control levels. Therefore, when cooking any food, do not let any portion extend above the ⅔ full level.

Rice and dry beans and peas expand during cooking. When preparing these foods, do not fill the canner over ½ full. **Always pre-soak dry beans and peas overnight in oil, salt, and water (see pages 30-31). Never pressure cook applesauce, cranberries, rhubarb, pearl barley, split peas, oatmeal or other cereals, dried soup mixes, or pasta.** These foods tend to foam, froth, and sputter and may block the vent pipe.

If the vent pipe becomes clogged, the pressure regulator will not rock and pressure cannot be released normally. When excess pressure builds up in the canner, the overpressure plug will be forced out of its cover opening, releasing the excess pressure. If the overpressure plug is ever forced out of its cover opening due to excess pressure while cooking or canning, it is important to call the Test Kitchen at 1-800-368-2194. **Do not attempt to use the released overpressure plug.**

The canning-cooking rack can be used to hold foods above the liquid level. This will allow cooking several different foods at the same time without an intermingling of flavors. When a natural blending of flavors is desired, do not use the canning-cooking rack. When cooking two or more foods at the same time, choose those which require the same length of cooking time. The length of cooking time for a specific food varies greatly with the thickness of the food. For example, a ½-inch thick slice of potato will be done in 3 minutes whereas a ¾-inch thick slice of potato will be done in 5 minutes. For foods which do not require the same cooking time, the canner may be quick cooled when there is just enough cooking time left for the food requiring the shorter cooking time. When the pressure is completely reduced, the cover may be opened and the food added. Then, again place the cover on the canner and proceed with cooking.

Questions?

For answers to any questions regarding recipes or timetables, call or write: Test Kitchen, National Presto Industries, Inc., 3925 North Hastings Way, Eau Claire, Wisconsin 54703-3703, phone 1-800-368-2194. You may also contact us at our website www.gopresto.com. When writing, please include a phone number and a time when you can be reached during weekdays if possible. Inquiries will be answered promptly by letter, telephone, or email.

HOW TO PRESSURE COOK FOODS

To assure the very best results every time, carefully follow these step-by-step instructions for pressure cooking. You may find it helpful to refer back to the diagrams on pages 3 through 5.

1. Prepare ingredients according to the directions in the pressure cooking recipe you have selected. Pour liquid into the canner body, as specified in the recipe or timetable. This liquid is usually water. However, some recipes will call for other liquids, such as wine.
2. Place the cooking rack into the canner, if called for in the recipe (see Helpful Hints on page 23 for guidance on when to use).

3. **IMPORTANT:** Look through the vent pipe to make certain that it is clear before closing the cover. See safety information on page 23.
4. Place cover on canner, aligning the **V** mark on the cover with the **A** mark on the body handle and lock securely by turning in the direction indicated to close (clockwise). **Cover handles must be centered directly over body handles. Do not force beyond this position.** If the cover is difficult to lock at this point, it is due to expansion of the canner from heating. If this occurs, remove cover and allow the canner to cool slightly. Do not replace canner on burner until cover is in its fully closed position (cover handles directly above body handles).

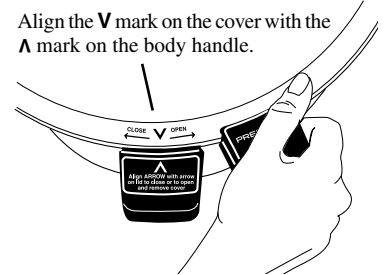
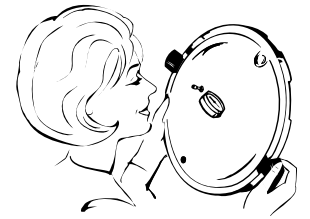

Align the **V** mark on the cover with the **A** mark on the body handle.

5. Place pressure regulator on vent pipe. Heat canner until pressure dial gauge registers 15 pounds pressure. A relatively high heat setting is necessary for most range burners. Cooking time begins when pressure gauge registers 15 pounds pressure. Adjust heat to maintain 15 pounds pressure on the pressure dial gauge to prevent excess steam from escaping. (If the pressure regulator begins to rock before 15 pounds pressure is reached on the gauge, lower heat to maintain a slow, steady rocking motion of the pressure regulator and cook at this pressure.)
6. Cook for the length of time specified in recipe. When cooking time is completed, turn off gas burner or remove canner from electric burner. **Lift pressure canner to remove it from burner. Sliding cookware can leave scratches on stovetop.** Reduce pressure according to recipe.
 - 7A. When recipe states “let pressure drop of its own accord”, set the canner aside to cool. Pressure is completely reduced when the air vent/cover lock and overpressure plug have dropped and no steam escapes when the pressure regulator is tilted. Do not use the pressure dial gauge as an indicator of when pressure is completely reduced.
 - 7B. When recipe states “cool canner at once”, the canner must be cooled immediately under a water faucet or by pouring water over it. **Note: Do not set hot canner in a molded sink as it could damage the sink.**

When the air vent/cover lock and overpressure plug have dropped and no steam escapes when the regulator is tilted, pressure is completely reduced. Do not use the pressure dial gauge as an indicator of when pressure is completely reduced.
 - 7C. Or, cool at once by placing the canner in a pan of cold water until the air vent/cover lock and overpressure plug have dropped and no steam escapes when the regulator is tilted. Do not use the pressure dial gauge as an indicator of when pressure is completely reduced.
8. After the air vent/cover lock and overpressure plug have dropped and no steam escapes when the regulator is tilted, remove the pressure regulator. **Do not** remove the pressure regulator until pressure is completely reduced. **Always** remove the pressure regulator before opening the cover.
9. Remove cover by turning counter-clockwise until the **A** mark on the body handle aligns with the **V** mark on the cover. Lift cover toward you to keep steam away from you. If the cover is locked or turns hard after the regulator is removed, there may still be some pressure in the canner. **The cover should not be forced off.** Cool the canner until the body is cool enough for the cover to be removed easily.
10. Remove food and serve.



IMPORTANT SAFETY INFORMATION

Cooking under pressure enables you to prepare food both quickly and deliciously. If used properly, your pressure canner is one of the safest appliances in your kitchen. To ensure safe operation, make sure you always observe the following simple rules whenever you use the pressure canner:

1. **Never overfill the pressure canner.** — The pressure regulator is designed to maintain cooking pressures at a safe level. It relieves excess pressure through the vent pipe as it rocks back and forth. Many foods tend to expand when cooked. If the canner is overfilled, expansion of food may cause the vent pipe to become blocked or clogged. If the vent pipe becomes blocked, it cannot relieve excess pressure.

There are a few foods such as rice, grains, dry beans and peas, and soups which expand so much or foam and froth while cooking that the canner should never be filled more than half full. For other foods, never fill the canner more than two-thirds full.
2. **Always add cooking liquid.** — If an empty pressure canner is left on a hot burner or if a canner boils dry and is left on a heated burner, the canner will overheat excessively causing possible discoloration and/or warping of the canner.

3. **Always look through the vent pipe before using the canner to make sure it is clear.** — If the vent pipe is blocked, it cannot function as it should and thus cannot relieve excess pressure. Pressure may then build to unsafe levels. To clean the vent pipe, draw a pipe cleaner or small brush through the opening, as shown on page 4. Also clean the vent pipe nut as shown.
4. **Always fully close the pressure canner.** — The canner is fully closed when the cover handles are directly above the body handles. Your pressure canner has specially designed lugs on the cover and body which lock the cover in place when the canner is fully closed. However, if the canner is not fully closed, the lugs cannot lock the cover onto the body. It's possible that pressure could build inside the canner and cause the cover to come off and result in bodily injury or property damage. Always be sure the cover handles are directly above the body handles. Do not turn past handle alignment.
5. **Never open the canner when it contains pressure.** — The air vent/cover lock provides a visual indication of pressure inside the canner. When it is up, there is pressure. When it is down, there is no pressure in the canner and it can be opened. If the pressure canner is opened before all of the pressure is released, the contents of the canner will erupt and could cause bodily injury or property damage.
6. **Replace the overpressure plug if it is hard, deformed, cracked, worn or pitted, or when replacing the sealing ring. Replace the sealing ring if it becomes hard, deformed, cracked, worn, pitted, or soft and sticky.** — The overpressure plug is a secondary pressure relief valve which is designed to relieve excess pressure by releasing from the canner cover in the event that the vent pipe becomes blocked. The overpressure plug is made of rubber, and when new, is soft and pliable. Over time, depending on the frequency and type of use, rubber becomes hard and inflexible. When hard and inflexible, the overpressure plug loses its ability to act as a secondary pressure relief valve. It should be replaced immediately.

Should the overpressure plug ever be forced out of the cover due to excess pressure while cooking, it is important to call the Test Kitchen at 1-800-368-2194. **Do not attempt to use the released overpressure plug.**
7. **Always follow special procedures found in the instruction book when pressure cooking dry beans and peas.** — During cooking, dry beans and peas tend to froth and foam which could cause the vent pipe to become blocked. Therefore, dry beans and peas need to be soaked and cooked according to the specific recipe. Using this method will keep foam at safe levels during cooking.
8. **Never pressure cook applesauce, cranberries, rhubarb, cereals, pastas, or dried soup mixes.** — These foods expand so much as a result of foaming and frothing that they should never be cooked under pressure.

HELPFUL HINTS FOR PRESSURE COOKING

- ❖ Your favorite recipes may be adjusted for cooking in the canner by following the general directions in this book for the particular type of food being cooked. Decrease the length of cooking time by two thirds, since pressure cooking is much faster than ordinary cooking methods. Because there is little evaporation from the canner, the amount of liquid should be decreased. Add about 2 cups more liquid than desired in the finished product. There must always be water or some other liquid in the bottom of the canner to form the necessary steam.
- ❖ Use the cooking rack when it is desirable to cook foods out of the cooking liquid. When foods are pressure cooked out of the liquid, flavors will not intermingle. Therefore, it is possible to cook several foods at once, as long as they have similar cooking times. If it is desirable to blend flavors, do not use the cooking rack.
- ❖ When the body of your canner is heated, the metal expands. Therefore, it may be difficult to close cover on heated body. When this happens, allow canner to cool slightly.
- ❖ Foods are quickly cooked in the canner. Therefore, to prevent overcooking it is important to accurately time the cooking period.
- ❖ If your cooked food has more liquid than you desire, simmer to evaporate excess liquid.
- ❖ When pressure cooking at high altitudes, cooking time should be increased 5% for every 1000 feet above the first 2000 feet. Following this rule, the time would be increased as follows:

3000 5%	5000 15%	7000 25%
4000 10%	6000 20%	8000 30%
- ❖ If you have questions on recipes or timetables write to: Test Kitchen, National Presto Industries, Inc., 3925 North Hastings Way, Eau Claire, Wisconsin 54703-3703, phone 1-800-368-2194. You may also contact us at our website www.gopresto.com. Inquiries will be answered promptly by letter, phone, or email.

PRESSURE COOKING MEAT

Savory, tender meat is easily prepared in the canner. The most important step is to sear meat to a crispy brown on all sides to seal in natural juices.

Meat recipes are cooked at 15 pounds pressure.

Cooking time depends on the amount and distribution of fat and bone, toughness, size and thickness of cut, grade and cut of meat, and the manner in which the meat fits into the canner. Rolled roasts require a longer cooking time per pound than roasts with bone. Short, chunky roasts take longer to cook than long, flat roasts. Because of the difference in thickness, a small, thick roast requires a longer cooking time per pound than a heavier, flat roast.

The following recipes were written for fresh or completely thawed meats. To cook frozen meats, thaw half an hour or more, just enough so that the meat will have contact with the bottom of the canner and sear crispy brown. Then increase the cooking times given in the recipes. Frozen beef, veal, and lamb should be cooked 25 minutes per pound—frozen pork, 30 minutes per pound.

After pressure cooking time is completed, serving size pieces of meat may be quick cooled. However, when cooking a roast cut of meat, pressure must drop of its own accord to be sure that pressure is reduced both within the roast and the canner.

After cooking, if more crispness is desired, place meat under a broiler 1 to 3 minutes. If gravy is desired, stir 2 to 4 tablespoons of flour or cornstarch into ½ cup cold water. Heat liquid in canner and stir in flour mixture. Heat to boiling, stir constantly for 1 minute or until thickened. Season with salt and pepper.

DO NOT FILL CANNER OVER TWO-THIRDS FULL!

These recipes are intended for pressure cooking and should not be canned.

COOKING RECIPES: MEAT

POT ROAST

9 lbs. beef shoulder or rump roast	2 onions, sliced
Salt and pepper	4 cups water
¼ cup cooking oil	

Heat canner, add oil, and brown meat well on all sides. Place cooking rack and roast in canner. Season roast with salt, pepper, and onion; add water. Close cover securely. Place pressure regulator on vent pipe and COOK 45 MINUTES at 15 pounds pressure. Let pressure drop of its own accord. *15-18 servings.*

ITALIAN BEEF

9 lbs. rump or chuck roast	1 tablespoon salt, or as desired
3 tablespoons cooking oil	2 cups sliced mushrooms
3 onions, chopped	3 6-ounce cans tomato paste
2 cups diced celery	2 10½-ounce cans beef broth
3 carrots, chopped	1½ cups red wine
3 bay leaves	

Heat canner, add oil, and brown roast on all sides. Add prepared vegetables and seasonings. Blend tomato paste with broth and wine. Pour over meat. Close cover securely. Place pressure regulator on vent pipe and COOK 35 MINUTES at 15 pounds pressure. Let pressure drop of its own accord. Thicken gravy, if desired. *15-18 servings.*

BRAISED BEEF

6 slices salt pork	4 cups water
9 lbs. boneless beef, round or rump roast	1 cup diced turnips
Salt and pepper	1 cup diced carrots
Flour	3 onions, chopped
	1 cup chopped celery

Heat canner and brown salt pork. Season roast with salt and pepper; dredge in flour. Brown roast well on all sides. Add water and vegetables. Close cover securely. Place pressure regulator on vent pipe and COOK 40 MINUTES at 15 pounds pressure. Let pressure drop of its own accord. *15-18 servings.*

SWISS STEAK

12 lbs. round steak, 1 inch thick cut into serving pieces	¼ cup cooking oil
1 cup flour	2 onions, chopped
Salt and pepper	1 green pepper, chopped
	4 cups tomato juice

Season flour with salt and pepper; pound flour into meat. Heat canner, add oil, and brown meat on both sides. Add remaining ingredients. Close cover securely. Place pressure regulator on vent pipe and COOK 15 MINUTES at 15 pounds pressure. Let pressure drop of its own accord. *24 servings.*

SHORT RIBS OF BEEF

10 lbs. beef short ribs, cut into serving pieces	1 green pepper, chopped
3 tablespoons cooking oil	2 cups tomatoes
3 onions, chopped	2 tablespoons salt
1 cup chopped celery	1 teaspoon pepper
	2 cups water

Heat canner, add oil, and brown ribs on all sides. Add remaining ingredients. Close cover securely. Place pressure regulator on vent pipe and COOK 40 MINUTES at 15 pounds pressure. Let pressure drop of its own accord. *15-18 servings.*

CORNERED BEEF

12 lbs. corned beef	3 cloves garlic
4 cups water	3 bay leaves

Cut garlic cloves in small pieces and insert in beef with a sharp knife. Place meat and water in canner. Add bay leaves. Close cover securely. Place pressure regulator on vent pipe and COOK 40-50 MINUTES at 15 pounds pressure. Let pressure drop of its own accord. *20-24 servings.*

HAM—BOILED

12 lbs. ham	5 cups water
--------------------	---------------------

Place ham and water in canner. Close cover securely. Place pressure regulator on vent pipe and COOK 70 MINUTES at 15 pounds pressure. Let pressure drop of its own accord. *20-24 servings.*

VIRGINIA HAM

10 lbs. ham	1½ cups brown sugar
4 cups water	Cloves

Place ham on cooking rack in canner. Add water. Close cover securely. Place pressure regulator on vent pipe and COOK 60 MINUTES at 15 pounds pressure. Let pressure drop of its own accord. Remove ham. Sprinkle with sugar and dot with cloves. Brown in a hot oven. *15-18 servings.*

HAM SLICES

¼ cup cooking oil	Cloves, if desired
4 slices ham, 1½ inches thick	3 cups water

Heat canner, add oil, and sear ham on all sides. Stud ham with cloves, if desired. Place cooking rack, ham, and water in canner. Close cover securely. Place pressure regulator on vent pipe and COOK 25 MINUTES at 15 pounds pressure. Let pressure drop of its own accord. *12-15 servings.*

PORK ROAST

6 lbs. pork roast	2 onions, sliced
2 tablespoons cooking oil	4 cups water
Salt and pepper	

Heat canner, add oil, and brown roast well on all sides. Season with salt, pepper, and sliced onion; add water. Close cover securely. Place pressure regulator on vent pipe and COOK 60 MINUTES at 15 pounds pressure. Let pressure drop of its own accord. *12-15 servings.*

LEMON PORK CHOPS

20	pork chops, ½ inch thick	1	tablespoon salt
¼	cup cooking oil	1	teaspoon pepper
20	lemon slices	2	cups catsup
4	onions, cut into rings	2	cups water

Heat canner, add oil, and brown pork chops on both sides. Top each chop with a lemon slice. Add onion, salt, and pepper. Combine catsup and water; pour over chops. Close cover securely. Place pressure regulator on vent pipe and COOK 10 MINUTES at 15 pounds pressure. Let pressure drop of its own accord. Serve chops with the sauce.

20 servings.

BREADED PORK CHOPS

18	pork chops, ¾ inch thick	¼	cup milk
	Salt and pepper	¼	cup cooking oil
3	cups corn flake crumbs	2	cups water
4	eggs, beaten		

Season pork chops with salt and pepper. Dredge with corn flake crumbs, then dip in combined egg and milk and again in crumbs. Heat canner, add oil, and brown pork chops on both sides. Place cooking rack, chops, and water in canner. Close cover securely. Place pressure regulator on vent pipe and COOK 10 MINUTES at 15 pounds pressure. Let pressure drop of its own accord. *18 servings.*

SPARERIBS WITH BARBECUE SAUCE

10	lbs. spareribs, cut into serving pieces	2	cups catsup
	Salt and pepper	1	cup vinegar
	Paprika	2	tablespoons Worcestershire sauce
3	tablespoons cooking oil	1	teaspoon chili powder
4	onions, sliced	1	teaspoon celery seed
		1	cup water

Season spareribs with salt, pepper, and paprika. Heat canner, add oil, and brown ribs on all sides. Add onion. Combine catsup, vinegar, Worcestershire sauce, chili powder, and celery seed; pour over meat in canner. Close cover securely. Place pressure regulator on vent pipe and COOK 15 MINUTES at 15 pounds pressure. Let pressure drop of its own accord. *12-15 servings.*

LEG OF LAMB

2	legs of lamb, 5-lbs. each	2	cloves garlic, minced
3	tablespoons cooking oil	4	cups water
	Salt and pepper		

Heat canner, add oil, and brown lamb. Add salt, pepper, garlic, and water. Close cover securely. Place pressure regulator on vent pipe and COOK 50 MINUTES at 15 pounds pressure. Let pressure drop of its own accord. *20-24 servings.*

CHINESE PINEAPPLE LAMB

6	lbs. boneless lamb, cut into 1½-inch cubes	3	cups beef stock
¼	cup cooking oil	2	16-ounce cans bean sprouts, drained
2	cups chopped onion	4	20-ounce cans pineapple chunks, drained
4	cups sliced celery	3	tablespoons cornstarch
4	3-ounce cans mushrooms	½	cup soy sauce
	Salt and pepper		

Heat canner, add oil, and brown meat. Add onion and celery; brown lightly. Add mushroom liquid, seasoning, and beef stock. Close cover securely. Place pressure regulator on vent pipe and COOK 10 MINUTES at 15 pounds pressure. Let pressure drop of its own accord. Add bean sprouts, pineapple, and mushrooms. Blend cornstarch and soy sauce and stir into mixture. Cook until thickened, stirring carefully. If desired, serve over chow mein noodles or steamed rice. *20-24 servings.*

VEAL ROAST

9 lbs. veal roast	3 tablespoons cooking oil
Salt and pepper	2 bay leaves
Flour	4 cups water

Season meat and dredge with flour. Heat canner, add oil, and brown meat well on all sides. Place cooking rack and roast in canner. Add bay leaves and water. Close cover securely. Place pressure regulator on vent pipe and COOK 45 MINUTES at 15 pounds pressure. Let pressure drop of its own accord. *15-18 servings.*

GOURMET VEAL STEAK

12 lbs. veal round steak, cut into serving pieces	2 lemons, thinly sliced
¼ cup cooking oil	2 chicken bouillon cubes
1 tablespoon salt, or as desired	1 cup boiling water
1 teaspoon pepper	1 cup sherry

Heat canner, add oil, and brown meat. Sprinkle with salt and pepper; top with lemon slices. Add bouillon cubes dissolved in boiling water and wine. Close cover securely. Place pressure regulator on vent pipe and COOK 10 MINUTES at 15 pounds pressure. Let pressure drop of its own accord. *24 servings.*

BRAISED VEAL

9 lbs. veal roast	1 tablespoon salt, or as desired
¼ cup cooking oil	¼ teaspoon thyme
1 onion, minced	4 cups water

Heat canner, add oil, and brown meat well on all sides. Place cooking rack and roast in canner. Add onion, seasonings, and water. Close cover securely. Place pressure regulator on vent pipe and COOK 45 MINUTES at 15 pounds pressure. Let pressure drop of its own accord. *15-18 servings.*

TANGY VEAL CHOPS

18 veal chops, ¾ inch thick	3 tablespoons lemon juice
3 tablespoons cooking oil	2 onions, chopped
Salt and pepper	2 cups water
2 teaspoons paprika	20 stuffed olives, sliced
½ cup brown sugar	

Heat canner, add oil, and brown chops on both sides. Combine seasonings, brown sugar, lemon juice, onion, and water. Pour over meat. Sprinkle olives over top. Close cover securely. Place pressure regulator on vent pipe and COOK 15 MINUTES at 15 pounds pressure. Let pressure drop of its own accord. Remove meat, thicken gravy, if desired. *18 servings.*

PRESSURE COOKING ENTREES

Try these suggested entrees. Then experiment with entrees of your own. Entree recipes are cooked at 15 pounds pressure. Always remember to select foods that cook in the same length of time. Favorite recipes may be adjusted to pressure cooking by following the general directions for the particular type of food being cooked. Decrease the length of cooking time by two-thirds, since pressure cooking requires only one-third as much time as ordinary methods of cooking. Decrease the amount of liquid as there is little evaporation from the canner. Add about 2 cups more liquid than desired in the finished product.

DO NOT FILL CANNER OVER TWO-THIRDS FULL!

These recipes are intended for pressure cooking and should not be canned.

COOKING RECIPES: ENTREES

SPAGHETTI MEAT SAUCE

6 lbs. ground beef	3 12-ounce cans tomato paste
4 onions, chopped	3 quarts tomato juice
4 cloves garlic, minced	¼ cup sugar
2 cups chopped celery	½ teaspoon cayenne pepper
2 green peppers, diced	2 tablespoons oregano
1 tablespoon salt, or as desired	

Heat canner and brown beef. Add remaining ingredients. Close cover securely. Place pressure regulator on vent pipe and COOK 10 MINUTES at 15 pounds pressure. Let pressure drop of its own accord. Serve sauce over spaghetti and sprinkle with Parmesan cheese. 20-24 servings.

BEEF GOULASH

6 lbs. chuck roast, cut into 2-inch cubes	4 garlic cloves, minced
3 tablespoons cooking oil	8 onions, chopped
Salt and pepper	16 allspice corns
1½ teaspoons paprika	2 6-ounce cans tomato paste
4 cups water	12 potatoes

Heat canner, add oil, and brown meat. Season with salt, pepper, and paprika. Add water, garlic, onions, allspice corns, and tomato paste. Place potatoes around meat. Close cover securely. Place pressure regulator on vent pipe and COOK 15 MINUTES at 15 pounds pressure. Let pressure drop of its own accord. 12-15 servings.

MEAT CABBAGE ROLLS

2 large heads cabbage	3 cups cooked rice
Hot water	3 cups milk
3 lbs. ground beef	½ cup brown sugar
2 tablespoons salt	2 cups water
¾ teaspoon pepper	

Dip cabbage leaves in hot water. Dry leaves on towel. Combine meat, salt, pepper, cooked rice, and milk. Place a tablespoon of meat mixture onto each leaf; roll leaf around meat and fasten with toothpick. Place cooking rack and cabbage rolls in canner. Sprinkle with brown sugar and add water. Close cover securely. Place pressure regulator on vent pipe and COOK 10 MINUTES at 15 pounds pressure. Let pressure drop of its own accord. 12-15 servings.

BEEF STEW

3	tablespoons cooking oil	3	cups green beans
4	lbs. beef, cut into 1-inch cubes	12	carrots, halved
4	onions, sliced	3	cups tomatoes
	Salt and pepper		* * * * *
2	cups water	3	tablespoons flour
12	potatoes, halved	¾	cup water

Heat canner, add oil, and brown meat. Add onion, salt, pepper, water, potatoes, green beans, carrots, and tomatoes. Close cover securely. Place pressure regulator on vent pipe and COOK 8 MINUTES at 15 pounds pressure. Let pressure drop of its own accord. Make a paste of flour and ¾ cup water and stir into stew to thicken.

15-18 servings.

CHILI CON CARNE

6	lbs. ground beef	½	teaspoon cayenne pepper
4	onions, chopped	2	tablespoons chili powder
2	green peppers, chopped	1	cup water
2	cloves garlic, minced		* * * * *
1	16-ounce can tomato sauce	3	16-ounce cans kidney beans, drained and rinsed
3	16-ounce cans tomatoes		
1	tablespoon salt, or as desired		

Heat canner and brown beef, breaking it apart to assure even browning. Add onions, green pepper, and garlic and brown lightly. Add remaining ingredients. Close cover securely. Place pressure regulator on vent pipe and COOK 15 MINUTES at 15 pounds pressure. Let pressure drop of its own accord. Stir in kidney beans and heat through. *18-20 servings.*

PORK CHOPS WITH VEGETABLES

3	tablespoons cooking oil	2	cups water
15	pork chops, ¾ inch thick	15	potatoes
	Salt and pepper	15	carrots

Heat canner, add oil, and brown pork chops on both sides. Season with salt and pepper. Add water, potatoes, and carrots. Close cover securely. Place pressure regulator on vent pipe and COOK 10 to 12 MINUTES at 15 pounds pressure. Let pressure drop of its own accord. *15 servings.*

SPARERIBS AND SAUERKRAUT

6	lbs. spareribs, cut into serving pieces	3	quarts sauerkraut
3	tablespoons cooking oil	3	tablespoons brown sugar
	Salt and pepper	2	cups water

2 cups water Heat canner, add oil, and brown ribs on both sides. Season with salt and pepper. Place sauerkraut over ribs and sprinkle with brown sugar. Add water. Close cover securely. Place pressure regulator on vent pipe and COOK 15 MINUTES at 15 pounds pressure. Let pressure drop of its own accord. *12 servings.*

PORK HOCKS WITH SAUERKRAUT AND POTATOES

9	lbs. pork hocks	2	quarts sauerkraut
3	cups water	2	onions, chopped
¼	teaspoon pepper	12	potatoes, halved

Place hocks, water, and pepper in canner. Close cover securely. Place pressure regulator on vent pipe and COOK 45 MINUTES at 15 pounds pressure. Let pressure drop of its own accord. Add sauerkraut, onions, and potatoes. Close cover securely. Place pressure regulator on vent pipe and COOK 10 MINUTES at 15 pounds pressure. Let pressure drop of its own accord. *12-15 servings.*

NEW ENGLAND BOILED DINNER

4 lbs. ham shank	12 carrots, halved
3 cups water	1 cabbage, cut in wedges
12 potatoes, halved	1 teaspoon pepper
12 onions, halved	

Place ham and water in canner. Close cover securely. Place pressure regulator on vent pipe and COOK 20 MINUTES at 15 pounds pressure. Let pressure drop of its own accord. Add vegetables and pepper. Close cover securely. Place pressure regulator on vent pipe and COOK 8 MINUTES at 15 pounds pressure. Let pressure drop of its own accord. *12 servings.*

LAMB STEW

3 tablespoons cooking oil	8 onions, diced
6 lbs. breast of lamb, cut into 1-inch cubes	2 tablespoons Worcestershire sauce
Salt and pepper	12 carrots, cut in half
3 green peppers, diced	2 cups water

Heat canner, add oil, and brown lamb well on all sides. Season with salt and pepper. Add green pepper, onion, Worcestershire sauce, carrots, and water. Close cover securely. Place pressure regulator on vent pipe and COOK 8 MINUTES at 15 pounds pressure. Let pressure drop of its own accord. *12 servings.*

BOSTON BAKED BEANS

6 cups dried beans	1 cup molasses
¾ cup cooking oil	1 cup catsup
3 tablespoons salt	4 onions, diced
Water	Water
1 lb. salt pork or bacon, diced	*****
½ cup brown sugar	Salt, as desired
2 teaspoons dry mustard	

Soak beans overnight in cooking oil, salt, and enough water to cover completely. Drain and discard liquid. Heat canner and sear salt pork or bacon. Remove excess drippings. Add beans, remaining ingredients, and enough water to well cover beans. **Do not fill canner over one-half full.** Close cover securely. Place pressure regulator on vent pipe and COOK 45 MINUTES at 15 pounds pressure. Let pressure drop of its own accord. Season to taste with salt. *12-15 servings.*

CHOP SUEY

3 tablespoons cooking oil	½ cup soy sauce
3 lbs. round steak, cubed	3 cups diced celery
1 lb. lean pork, cubed	2 cups water
1 lb. lean veal, cubed	*****
Salt and pepper	3 16-ounce cans Chinese vegetables
3 onions, chopped	3 16-ounce cans bean sprouts

Heat canner, add oil, and brown meat well. Season with salt and pepper. Add onions, soy sauce, celery, liquid drained from vegetables, and water. Close cover securely. Place pressure regulator on vent pipe and COOK 10 MINUTES at 15 pounds pressure. Let pressure drop of its own accord. Add canned vegetables to meat. Heat in open canner. Serve with steamed rice, if desired. *12-15 servings.*

LIMA BEANS WITH BACON

6 cups dried lima beans	1 lb. bacon, diced
¾ cup cooking oil	Water
3 tablespoons salt	*****
Water	Salt, as desired

Soak beans overnight in cooking oil, salt, and enough water to cover completely. Drain and discard liquid. Heat canner and brown bacon. Add beans and enough water to well cover beans. **Do not fill canner over one-half full.** Close cover securely. Place pressure regulator on vent pipe and COOK 25 MINUTES at 15 pounds pressure. Let pressure drop of its own accord. Season to taste with salt. *12-15 servings.*

LIMA BEAN POT

6 cups dried lima beans	1 cup chopped celery
¾ cup cooking oil	6 cups tomato juice
3 tablespoons salt	½ cup brown sugar
Water	1 tablespoon chili powder
2 lbs. pork sausages, cut into ½-inch pieces	½ teaspoon cayenne pepper
3 onions, chopped	*****
1 green pepper, diced	Salt, as desired

Soak beans overnight in cooking oil, salt, and enough water to cover completely. Drain and discard liquid. Heat canner and brown sausage. Remove. Pour off all drippings in excess of two tablespoons. Sauté onions, green pepper, and celery. Add lima beans and sausage. Add combined tomato juice, brown sugar, chili powder, and cayenne pepper. Mix well. **Do not fill canner over one-half full.** Close cover securely. Place pressure regulator on vent pipe and COOK 25 MINUTES at 15 pounds pressure. Let pressure drop of its own accord. Season to taste with salt. *12-15 servings.*

SHRIMP JAMBALAYA

3 tablespoons cooking oil	1 cup water
2 cloves garlic	3 1-lb. cans tomatoes
2 cups chopped onion	3 6-ounce cans sliced mushrooms, with liquid
2 lbs. precooked ham, diced	3 lbs. peeled and cleaned shrimp
3 cups uncooked rice	2 green peppers, cut into strips
1 tablespoon salt, or as desired	
½ teaspoon pepper	
½ teaspoon allspice	
Pinch each, cayenne, chili powder, and basil	

Heat canner, add oil, and sauté garlic and onion until golden brown. Stir in ham and rice. Cook until rice is golden. Remove garlic. Add seasonings, water, tomatoes, and mushrooms with liquid; mix well. Add shrimp and sprinkle green pepper strips over all. Close cover securely. Place pressure regulator on vent pipe and COOK 5 MINUTES at 15 pounds pressure. Let pressure drop of its own accord. Remove cover and stir. Let stand 5 minutes before serving. *15-18 servings.*

PRESSURE COOKING POULTRY

Poultry recipes are cooked at 15 pounds pressure. Try the following suggested recipes and enjoy tasty poultry in a variety of sauces. Or, prepare your own favorite poultry dishes. When you wish to seal the natural juices into the poultry, sear to a crispy brown prior to pressure cooking. When it is desirable to intermingle food flavors, during cooking, it is best not to brown poultry; just cook it in the liquid indicated in the recipe.

DO NOT FILL CANNER OVER TWO-THIRDS FULL!

These recipes are intended for pressure cooking and should not be canned.

COOKING RECIPES: POULTRY

BRAISED WHOLE CHICKEN

3 3-lb. chickens	Salt and pepper
3 tablespoons cooking oil	2 cups water

Remove neck bone, fold skin down on breast and skewer in position. Fasten legs and wings close to side of body. Heat canner, add oil, and brown chickens on all sides. Season with salt and pepper. Place water, cooking rack, and chickens in canner. Close cover securely. Place pressure regulator on vent pipe and COOK 10 MINUTES at 15 pounds pressure. Let pressure drop of its own accord. *15-18 servings.*

CHICKEN IMPERIAL

9 lbs. chicken, cut into serving pieces	1 cup slivered almonds
¼ cup cooking oil	4 4-ounce cans mushrooms
1 tablespoon salt, or as desired	2 chicken bouillon cubes
1 teaspoon pepper	1 cup hot water
½ cup minced onion	1 cup white wine

Heat canner, add oil, and brown chicken. Season with salt and pepper. Add onions, almonds, mushrooms with liquid, bouillon cubes dissolved in hot water, and wine. Close cover securely. Place pressure regulator on vent pipe and COOK 10 MINUTES at 15 pounds pressure. Let pressure drop of its own accord. Remove chicken from canner, thicken gravy. If desired, serve chicken on bed of hot rice, top with gravy and toasted almonds. *15-18 servings.*

CHICKEN AND DUMPLINGS

9 lbs. chicken, cut into serving pieces	3 carrots, chopped
2 tablespoons salt	3 onions, chopped
1 teaspoon pepper	3 ribs celery, chopped
	8 cups water

Place all ingredients in canner. Close cover securely. Place pressure regulator on vent pipe and COOK 5 MINUTES at 15 pounds pressure. Let pressure drop of its own accord. Prepare dumplings as follows.

Dumplings

2 cups flour	⅔ cup milk
1 teaspoon salt	¼ cup cooking oil
1 tablespoon baking powder	1 tablespoon parsley flakes
2 eggs	

Sift flour, salt, and baking powder. Beat eggs; add milk, oil, and parsley. Combine liquid and dry ingredients. Drop from teaspoon into hot chicken broth. Simmer without cover for 15 minutes. Thicken broth if desired. *15-18 servings.*

CHICKEN MARENGO

9 lbs. chicken, quartered	2 cloves garlic, minced
1 tablespoon coarse black pepper	4 3-ounce cans sliced mushrooms, drained (or 1 lb. mushrooms, sliced)
1 cup flour	4 16-ounce cans tomatoes
1 tablespoon salt, or as desired	2 cups dry white wine
⅓ cup cooking oil	

Rub chicken with pepper. Dredge in flour and season with salt. Heat canner, add oil and garlic. Brown chicken. Add mushrooms, tomatoes, and 1 cup wine. Close cover securely. Place pressure regulator on vent pipe and COOK 10 MINUTES at 15 pounds pressure. Let pressure drop of its own accord. Remove chicken from canner. Add remaining wine and simmer. Thicken, if desired. *15-18 servings.*

CORNISH HENS IN WHITE WINE

¼ cup cooking oil	2 cups white cooking wine
8 cornish hens	2 teaspoons instant chicken bouillon
2 teaspoons salt	1 teaspoon thyme
1 teaspoon pepper	1 tablespoon chopped parsley

Heat canner, add oil, and brown hens. Season with salt and pepper. Combine remaining ingredients and pour over hens. Close cover securely. Place pressure regulator on vent pipe and COOK 8 MINUTES at 15 pounds pressure. Let pressure drop of its own accord. *8-12 servings.*

HUNTER'S TURKEY

9 lbs. turkey, cut into serving pieces	1 cup chicken broth
Flour, salt and pepper	2 bay leaves
⅓ cup cooking oil	1 teaspoon thyme
3 onions, chopped	1 teaspoon marjoram
3 8-ounce cans tomato sauce	1 tablespoon Worcestershire sauce

Dredge turkey in seasoned flour. Heat canner, add oil, and brown turkey. Add combined onion, tomato sauce, chicken broth, bay leaf, thyme, marjoram, and Worcestershire sauce. Close cover securely. Place pressure regulator on vent pipe and COOK 10 MINUTES at 15 pounds pressure. Let pressure drop of its own accord. *15-18 servings.*

FLORIDA DUCK

- | | |
|--------------------------------------|----------------------------------|
| 9 lbs. duck, cut into serving pieces | 2 cups white cooking wine |
| Salt and pepper | 2 tablespoons grated orange rind |
| 1 tablespoon cooking oil | |

Remove as much fat as possible from duck. Season with salt and pepper. Heat canner, add oil, and brown duck. Pour off excess drippings. Combine cooking wine and orange rind. Pour over duck. Close cover securely. Place pressure regulator on vent pipe and COOK 12 MINUTES at 15 pounds pressure. Let pressure drop of its own accord. Remove duck and thicken gravy, if desired. *18 servings.*

PRESSURE COOKING SOUPS

Make homemade soups the easy way in your canner. If you wish to prepare your family's favorite soup, use the following recipes as guides. Soup recipes are cooked at 15 pounds pressure.

Do not pressure cook soups containing barley, rice, pasta, split peas, or soup mixes with dried vegetables because they have a tendency to foam, froth, and sputter and could clog the vent pipe. See page 21.

The canner quickly transfers natural flavor and nutrients from the meat into the broth. Prepare either the Brown Beef Soup Stock or the Chicken Soup Stock according to the recipe. Remove the pieces of meat. If desired, cut into small pieces and use in soup recipes. Strain through several layers of cheese cloth. Once the stock is prepared, serve it as a consommé or use it to prepare delicious soups.

FOR SOUP RECIPES DO NOT FILL CANNER OVER ONE-HALF FULL!

These recipes are intended for pressure cooking and should not be canned.

COOKING RECIPES: SOUP

VEGETABLE SOUP

- | | |
|--------------------------|----------------------------------|
| 4 lbs. soup meat | 4 cups canned or fresh tomatoes |
| 2 quarts water | 1 cup diced celery |
| 6 carrots, diced | 4 onions, sliced |
| 6 potatoes, diced | 1 tablespoon salt, or as desired |
| 2 cups frozen lima beans | |

Place all ingredients in canner. Close cover securely. Place pressure regulator on vent pipe and COOK 20 MINUTES at 15 pounds pressure. Let pressure drop of its own accord. *12-15 servings.*

CHICKEN SOUP STOCK

- | | |
|---|----------------------------------|
| 4 lbs. chicken, cut into serving pieces | 1 cup diced carrots |
| 4 quarts water | 2 onions, chopped |
| 1 cup diced celery | 1 tablespoon salt, or as desired |

Place all ingredients in canner. Close cover securely. Place pressure regulator on vent pipe and COOK 10 MINUTES at 15 pounds pressure. Let pressure drop of its own accord. Strain stock. *12-15 servings.*

NAVY BEAN SOUP

- | | |
|--------------------------|---------------------------|
| 4 cups dried navy beans | 4 ribs celery, sliced |
| ½ cup vegetable oil | ¼ cup minced green pepper |
| 2 tablespoons salt | 2 cups tomato sauce |
| Water | 2 whole cloves |
| 3 lbs. ham bone or shank | 3 quarts water |
| 2 onions, chopped | ***** |
| 4 carrots, sliced | Salt and pepper |

Soak beans overnight in vegetable oil, salt, and water to cover completely. Drain and discard liquid. Place beans and all remaining ingredients in canner. Close cover securely. Place pressure regulator on vent pipe and COOK 30 MINUTES at 15 pounds pressure. Let pressure drop of its own accord. Season to taste with salt and pepper. *12-15 servings.*

CLAM CHOWDER

1 lb. salt pork, cubed	Salt and pepper
6 cups water	*****
4 onions, minced	4 quarts clams, minced
12 cups diced potatoes	4 quarts hot milk
4 cups corn	½ cup butter

Heat canner and brown salt pork. Add vegetables, water, salt, and pepper. Close cover securely. Place pressure regulator on vent pipe and COOK 5 MINUTES at 15 pounds pressure. Let pressure drop of its own accord. Add clams and boil, without cover, for 2 minutes. (Additional cooking will toughen clams.) Add milk and butter. *16 servings.*

BROWN BEEF SOUP STOCK

3 tablespoons cooking oil	1 cup chopped celery
4 lbs. beef, cubed	1 cup diced turnips
3 quarts water	2 tablespoons parsley flakes
1 cup sliced onion	1 bay leaf
1 cup diced carrots	1 tablespoon salt, or as desired

Heat canner, add oil, and brown beef. Add remaining ingredients. Close cover securely. Place pressure regulator on vent pipe and COOK 20 MINUTES at 15 pounds pressure. Let pressure drop of its own accord. Strain stock. *12-15 servings.*

PRESSURE COOKING DESSERTS

Your canner offers a shortened method for preparing steamed breads and desserts. Actually the cooking time can be counted in minutes instead of hours. You will find, too, that your canner is easier to use than the ordinary steamer because its pressure regulator acts as a means of measurement to assure constant heat to produce uniform even-textured products. **Consult specific recipes for cooking pressure.**

Best results are obtained when 1- to 1½- quart molds are used. Any type of mold is satisfactory (metal, glass, earthenware, tin food cans). Remember, never fill molds over two-thirds full; this extra top-space is to allow ample space for rising. If molds used do not have a cover, aluminum foil or several thicknesses of wax paper should be tied securely over the top to prevent condensed moisture from falling into mold. Because the first part of the cooking period is steaming time, which permits foods to rise, at least three quarts water should be poured into the bottom of canner to allow for evaporation.

Adjust heat to allow a **moderate** flow of steam from the vent pipe.

DO NOT FILL CANNER OVER TWO-THIRDS FULL!

These recipes are intended for pressure cooking and should not be canned.

COOKING RECIPES: DESSERTS

BROWN BETTY

2 cups dry bread crumbs	9 apples, peeled, cored and sliced
½ cup sugar	½ cup melted butter
1 teaspoon cinnamon	1 quart water
1 lemon, juice and rind	

Combine crumbs, sugar, cinnamon, lemon juice, and grated rind. Place alternate layers of apples and crumb mixture in buttered bowl that may be set loosely in canner. Pour melted butter over top. Cover firmly with aluminum foil. Place water, cooking rack, and bowl in canner. Close cover securely. Place pressure regulator on vent pipe and COOK 20 MINUTES at 15 pounds pressure. Let pressure drop of its own accord.

12 servings.

CUSTARD

6 cups milk	1 teaspoon salt
6 eggs, beaten	1½ teaspoons vanilla
1 cup sugar	2 cups water

Scald milk and cool slightly. Combine eggs, sugar, and salt. Add milk slowly, stirring constantly. Add vanilla. Pour into individual custard cups and cover firmly with aluminum foil. Place water, cooking rack, and custard cups in canner. Close cover securely. Place pressure regulator on vent pipe and COOK 3 MINUTES at 15 pounds pressure. Cool canner at once. Chill. *12-14 servings.*

Chocolate Custard: Scald milk with 3 squares chocolate, grated. Follow vanilla custard directions.

Coconut Custard: Sprinkle 3 tablespoons coconut over top of each vanilla custard before cooking.

ENGLISH PLUM PUDDING

1 cup sifted all purpose flour	1/2 cup currants
1 teaspoon baking powder	1/2 cup chopped nuts
1/2 teaspoon salt	1 egg
1/2 teaspoon allspice	1/2 cup sugar
1/2 teaspoon cinnamon	1/2 cup ground suet
1/2 teaspoon nutmeg	1/3 cup milk
1/4 teaspoon ground cloves	3 quarts water
1/2 cup raisins	

Sift flour with baking powder, salt, and spices. Add fruits and nuts. Beat egg; add sugar, suet, and milk. Combine liquid and dry ingredients; mix well. Pour into buttered 1-quart mold. Cover mold firmly with aluminum foil. Place water, cooking rack, and mold in canner. Close cover securely. Allow steam to flow from vent pipe 20 minutes. Place pressure regulator on vent pipe and cook 50 minutes at 10 pounds pressure. Let pressure drop of its own accord.

BREAD PUDDING

4 cups cubed dry bread	1 cup raisins
4 cups hot milk	1 cup chopped nuts
1/2 teaspoon salt	4 eggs
1 cup brown sugar	1 teaspoon vanilla
1 teaspoon cinnamon	1 quart water
2 tablespoons butter	

Combine bread, hot milk, salt, brown sugar, cinnamon, butter, raisins, nuts, eggs, and vanilla. Turn into a buttered bowl that may be set loosely in canner. Cover bowl firmly with aluminum foil. Place water, cooking rack, and bowl in canner. Close cover securely. Place pressure regulator on vent pipe and COOK 20 MINUTES at 15 pounds pressure. Let pressure drop of its own accord. *12 servings.*

RICE PUDDING

1 quart milk	4 cups cooked rice
4 eggs, slightly beaten	1 teaspoon vanilla
2/3 cup sugar	2 cups water
1 teaspoon salt	

Scald milk and cool slightly. Combine eggs, sugar, and salt. Add milk slowly, stirring constantly. Add rice and vanilla. Pour into individual custard cups and cover firmly with aluminum foil. Place water, cooking rack, and custard cups in canner. Close cover securely. Place pressure regulator on vent pipe and COOK 3 MINUTES at 15 pounds pressure. Cool canner at once. Stir gently before chilling. *12-14 servings.*

Fruit and Nut Rice Pudding: Substitute brown sugar for white and add 1 cup raisins or dates and 1 cup walnuts to above recipe.

BROWN BREAD

2 cups graham flour	1 1/2 cups light molasses
2 cups corn meal	4 cups milk, sweet or sour
2 cups rye meal	2 cups raisins
2 teaspoons salt	3 quarts water
2 teaspoons soda	

Mix all dry ingredients. Add molasses, milk, and raisins. Beat well. Pour into 6 buttered molds (pint size). Cover firmly with aluminum foil. Place water, cooking rack, and molds in canner. Close cover securely. Allow steam to flow from vent pipe 20 minutes. Place pressure regulator on vent pipe and COOK 25 MINUTES at 10 pounds pressure. Let pressure drop of its own accord.

WHITE FRUIT CAKE

1 1/4 cups canned pineapple tidbits	2 cups chopped walnuts
2/3 cup chopped citron	1/2 cup flour
2/3 cup shredded lemon peel	1 cup shortening
1/2 cup chopped candied cherries	1 cup sugar
3/4 cup chopped dates	5 eggs
2/3 cup shredded orange peel	1 1/2 cups flour
1 cup chopped dried apricots	1 teaspoon salt
1/2 cup chopped figs	1 1/2 teaspoons baking powder
1 1/2 cups white raisins	1/4 cup pineapple juice
1/2 cup shredded coconut	3 quarts water

Drain pineapple, saving juice. Dredge fruits and nuts with 1/2 cup flour. Cream shortening and sugar. Add eggs, one at a time, beating mixture well after each addition. Sift flour, salt, and baking powder. Add alternately with pineapple juice. Pour over floured fruit and nuts; mix until well blended. Pour into 5 buttered molds (pint size). Cover firmly with aluminum foil. Place water, cooking rack, and molds in canner. Close cover securely. Allow steam to flow from vent pipe 20 minutes. Place pressure regulator on vent pipe and COOK 60 MINUTES at 10 pounds pressure. Let pressure drop of its own accord.

RECIPE INDEX

PRESSURE CANNING RECIPES

FRUITS AND TOMATOES	9	VEGETABLES (Cont.)		POULTRY	16
Apples	9	Beans—Fresh Lima	13	Cut-Up	16
Applesauce	9	Beans—Green, Wax, Italian	13	Rabbit	16
Apricots	10	Beets	13		
Berries	10	Carrots	13	FISH AND SEAFOOD	17
Cherries	10	Corn—Whole Kernel	13	Clams	17
Peaches	10	Greens	13	Crab	17
Pears	10	Mushrooms	14	Fish (General Method)	17
Plums	10	Okra	14	Tuna	17
Rhubarb	11	Peas—Green	14		
Tomatoes	11	Peppers—Hot or Sweet	14	SOUPS	18
Tomato Juice	11	Potatoes—Sweet	14	Beef Stock	18
Tomato Sauce	11	Potatoes—White	14	Chicken Stock	18
Salsa	11	Pumpkin and Winter Squash	15		
		MEAT	15		
VEGETABLES	12	Cut-Up	15		
Asparagus	12	Ground	16		
Beans or Peas—Dry	12				

BOILING WATER CANNING RECIPES

Apple Butter	20	Dill Pickles	20	Zesty Salsa	21
Bread and Butter Pickles	20	Raspberry Jam	20		

PRESSURE COOKING RECIPES

MEAT RECIPES	24	MEAT RECIPES (Cont.)		POULTRY RECIPES	31
Beef Recipes	24	Veal Recipes	27	Chicken, Braised Whole	31
Braised Beef	24	Braised Veal	27	Chicken and Dumplings	32
Corned Beef	25	Gourmet Veal Steak	27	Chicken Imperial	32
Italian Beef	24	Roast Veal	27	Chicken Marengo	32
Pot Roast	24	Tangy Veal Chops	27	Cornish Hens in White Wine	32
Short Ribs	25			Florida Duck	33
Swiss Steak	25	ENTREE RECIPES	28	Hunter's Turkey	32
		Beef Goulash	28		
Ham Recipes	25	Beef Stew	29	SOUP RECIPES	33
Boiled Ham	25	Boston Baked Beans	30	Brown Beef Stock	34
Ham Slices	25	Chili Con Carne	29	Chicken Stock	33
Virginia Ham	25	Chop Suey	30	Clam Chowder	34
		Lamb Stew	30	Navy Bean	33
Pork Recipes	25	Lima Bean Pot	31	Vegetable	33
Breaded Pork Chops	26	Lima Beans with Bacon	30		
Lemon Pork Chops	26	Meat Cabbage Rolls	28	DESSERT RECIPES	34
Roast	25	New England Boiled Dinner	30	Bread Pudding	35
Spareribs with Barbecue Sauce	26	Pork Chops with Vegetables	29	Brown Betty	34
		Pork Hocks with Sauerkraut and Potatoes	29	Brown Bread	35
Lamb Recipes	26	Shrimp Jambalaya	31	Custards	34
Chinese Pineapple Lamb	26	Spaghetti Meat Sauce	28	English Plum Pudding	35
Leg of Lamb	26	Spareribs and Sauerkraut	29	Rice Pudding	35
				White Fruit Cake	35

SERVICE AND PARTS INFORMATION

If you have any questions regarding the operation of your Presto® cooker or need parts for your cooker, contact us by any of these methods:

- Call 1-800-877-0441 weekdays 8:00 AM to 4:30 PM (Central Time)
- Email us at our website www.GoPresto.com
- Write: NATIONAL PRESTO INDUSTRIES, INC.
Consumer Service Department
3925 N. Hastings Way, Eau Claire, WI 54703-3703

Inquiries will be answered promptly by telephone, letter, or email. When writing, please include a phone number and a time when you can be reached during weekdays, if possible.

When contacting the consumer service department or when ordering replacement parts, please specify the model number and date code found stamped on the side of the canner body.

Any maintenance required for this canner, other than that described in the Care and Maintenance section of this book (pages 7 and 8), should be performed by our Factory Service Department. Be sure to indicate date of purchase and a description of the problem when sending a canner for repair. **Send canners for repair to:**

CANTON SALES AND STORAGE
Presto Factory Service Department
555 Matthews Drive, Canton, MS 39046-0529

The Presto Factory Service Department is equipped to service all PRESTO® appliances and supply genuine PRESTO® parts. Genuine PRESTO® replacement parts are manufactured to the same exacting quality standards as PRESTO® canners and are engineered specifically to function properly with its canners. Presto can only guarantee the quality and performance of genuine PRESTO® parts. "Look-alikes" might not be of the same quality or function in the same manner. To ensure that you are buying genuine PRESTO® replacement parts, look for the PRESTO® trademark.

PRESTO® canner replacement parts are available at Presto Authorized Service Stations and may also be available at hardware stores and other retail outlets. Parts may also be ordered on-line at www.GoPresto.com.

PRESTO® LIMITED WARRANTY

This quality PRESTO® appliance is designed and built to provide many years of satisfactory performance under normal household use. Presto pledges to the original owner that should there be any defects in material or workmanship during the first twelve (12) years after purchase, we will repair or replace it at our option. Our pledge does not apply to normal wear and tear including scratches, dulling of the polish, or staining; the repair or replacement of moving and/or perishable parts such as the sealing ring, dial gauge, overpressure plug, or air vent cover lock gasket; or for any damage caused by shipping. To obtain service under the warranty, return this PRESTO® product, shipping prepaid to the PRESTO® Factory Service Department. California residents may deliver this PRESTO® product to their nearest PRESTO® Authorized Service Station. When returning a product, please include a description of the defect and indicate the date the appliance was purchased.

We want you to obtain maximum enjoyment from using this PRESTO® appliance and ask that you read and follow the instructions enclosed. Failure to follow instructions, damage caused by improper replacement parts, abuse or misuse (including overheating and boiling the unit dry) will void this pledge. This warranty gives you specific legal rights, and you may also have other rights which vary from state to state. This is Presto's personal pledge to you and is being made in place of all other express or implied warranties.

NATIONAL PRESTO INDUSTRIES, INC.
Eau Claire, Wisconsin 54703-3703