

This Owner's Manual is provided and hosted by [Appliance Factory Parts](#).



BROAN QTXE110 FAN Owner's Manual

[Shop genuine replacement parts for BROAN QTXE110
FAN](#)



[Find Your BROAN HVAC Parts - Select From 1309 Models](#)

----- Manual continues below -----

QTXE SERIES FANS

MODELS QTXE050, QTXE080, QTXE110, QTXE150

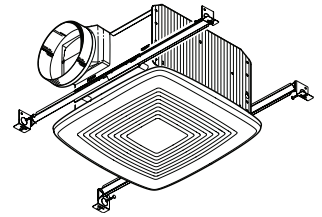

Ultra-quiet, high performance bath fan with a modern-styled grille.

FEATURES

BLOWER:

- Plug-in, permanently lubricated motor - engineered for continuous operation
- Dynamically balanced centrifugal blower wheel for quiet, efficient performance
- Maintains a high percentage of rated CFM in less than ideal installations
- Low RPM for quiet operation
- Resilient anti-vibration motor mounts (QTXE150 only)

HOUSING:

- Rugged, 26 gauge, galvanized steel construction
- 6" round ducting for superior performance
- Polymeric duct connector with tapered sleeve and no metallic clatter
- 7-5/8" height allows for 2" x 8" (nominal) joist installations
- Sturdy, easy, four-point mounting directly to joist
- Includes unique spacer (patent pending) for mounting to engineered "I" joists
- Includes hanger bars to position housing anywhere between 16" to 24"-on-center joists
- Two sets of mounting holes for hanger bars allow flush installation with bottom or top of drywall
- Can be mounted in ceilings up to 12/12 pitch

GRILLE:

- Polymeric construction
- Innovative design - the result of extensive research with designers and consumers

CONTROLS (Purchase separately):

- Model 69VL (Ivory) / 69WL (White) - One rocker switch with "on" indicator light
- Other controls available from Broan-NuTone

U.L. Listed for use over bathtubs and showers when connected to a GFCI protected branch circuit (ceiling mount only).

3-Year Warranty

TYPICAL SPECIFICATION

Ceiling Ventilator shall be Broan Model QTXE050 (QTXE080) (QTXE110) (QTXE150).

Ceiling Ventilator shall have corrosion resistant galvanized steel housing with four-point mounting capability. It shall be ducted to a roof or wall cap using 6" round ductwork.

Blower assembly shall be removable, have a centrifugal-type blower wheel and a permanently lubricated motor designed for continuous operation.

Non-metallic damper/duct connector shall be included.

Air delivery shall be no less than 50 (80) (110) (150) CFM and sound level no greater than <0.3 (0.3) (0.7) (1.4) Sones. All air and sound ratings shall be certified by HVI.

Ceiling ventilator shall be Energy Star® qualified and have an energy efficient permanent split capacitor motor.

Ceiling Ventilator shall be U.L. Listed for use over bathtubs and showers when connected to a GFCI protected branch circuit.



Broan-NuTone LLC Hartford, Wisconsin www.broan.com 800-558-1711

REFERENCE	QTY.	REMARKS	Project
			Location
			Architect
			Engineer
			Contractor
			Submitted by Date

PERFORMANCE RATINGS QTXE SERIES FANS

HVI PERFORMANCE

Model	Static Pressure (Ps)	CFM	Sones	Watts
QTXE050	0.10	50	< 0.3	19.7
	0.25	39		
QTXE080	0.10	80	0.3	23.3
	0.25	55		
QTXE110	0.10	110	0.7	33.5
	0.25	90		
QTXE150	0.10	150	1.4	51.3
	0.25	137		



HVI-2100 CERTIFIED RATINGS comply with new testing technologies and procedures prescribed by the Home Ventilating Institute, for off-the-shelf products, as they are available to consumers. Product performance is rated at 0.1 in. static pressure, based on tests conducted in a state-of-the-art test laboratory. Sones are a measure of humanly-perceived loudness, based on laboratory measurements.

AMPS

Model	Amps
QTXE050	0.2
QTXE080	0.2
QTXE110	0.3
QTXE150	0.5

WEIGHT

Model	Shipping Weight
QTXE050	12.4 lbs.
QTXE080	12.4 lbs.
QTXE110	13.0 lbs.
QTXE150	13.6 lbs.

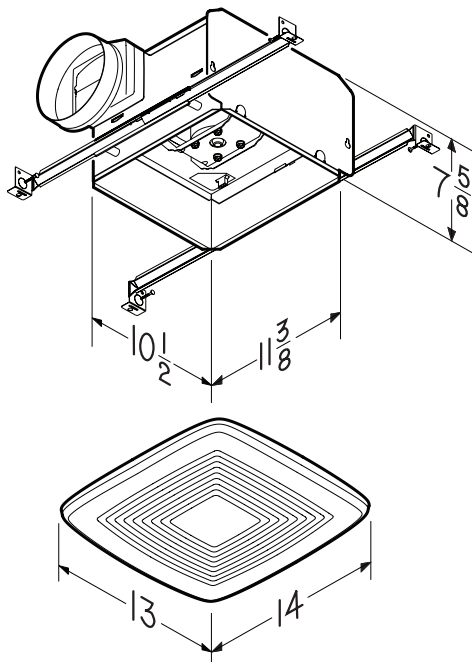

AIR FLOW PERFORMANCE

MODEL QTXE050

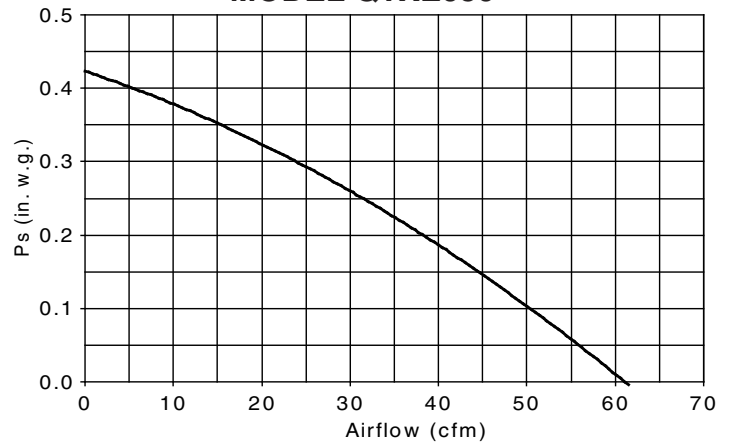

MODEL QTXE080

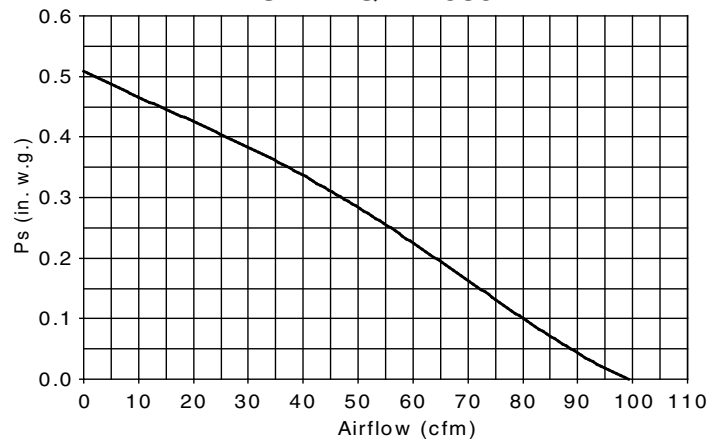

MODEL QTXE110

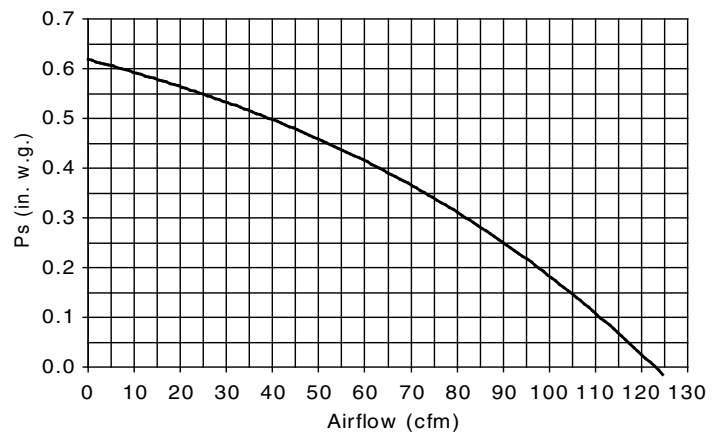

MODEL QTXE150

