

This Owner's Manual is provided and hosted by [Appliance Factory Parts](#).



BROAN 356BR Owner's Manual

[Shop genuine replacement parts for BROAN 356BR](#)



[Find Your BROAN HVAC Parts - Select From 1309 Models](#)

----- Manual continues below -----

ROOF MOUNTED POWERED ATTIC VENTILATORS

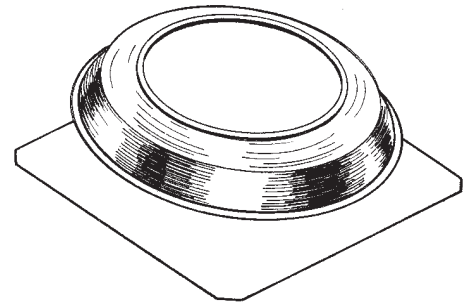

Powerful and easy to install, these units supplement or replace air conditioning by removing the blanket of hot, trapped air from attics - automatically.

FEATURES

- Precision balanced 14" metal blade for maximum air flow - minimum sound level
- PVC plastic dome provides ultraviolet protection and superior durability (Models 350, 350BK, 350BR, 355, 355BK, 355BR, 356, 356BK, 356BR)
- .050 aluminum dome (Model 358)
- 23 gage metal flashing - allows for nailing and hot tar application
- Mesh bird screen
- Built-in adjustable thermostat - for automatic operation at your chosen temperature level
- Thermally protected, permanently lubricated motor
- Mounts easily between rafters - installation template included

CONTROLS DESIGNED FOR USE WITH THESE PRODUCTS (purchase separately):

- Model 69V (Ivory)/69W (White) Single-Function Control
- Model 68V (Ivory)/68W (White) Two-Function Control
- Model 72V (Ivory)/72W (White) Electronic Variable Speed Control- 6 amp (not for use with Model 356)

SPECIFICATIONS

MODEL	VOLTS	AMPS	RPM	CFM	ATTIC MAX. SQ. FT.	MIN. INLET AREA
350, 350BK, 350BR	120	3.6	1000	1050	1500	3.5 SQ. FT.
355, 355BK, 355BR	120	4.3	1050	1200	1715	4.0 SQ. FT.
356, 356BK, 356BR	120	8.0	1500	1600	2285	5.5 SQ. FT.
358	120	4.3	1050	1200	1715	4.0 SQ. FT.



HVI-2100 CERTIFIED RATINGS comply with new testing technologies and procedures prescribed by the Home Ventilating Institute, for off-the-shelf products, as they are available to consumers. Product performance is rated at 0.1 in. static pressure, based on tests conducted in a state-of-the-art test laboratory. Sones are a measure of humanly-perceived loudness, based on laboratory measurements.

TYPICAL SPECIFICATION

Roof Mounted Attic Ventilator shall be Broan Model 350 (350BK) (350BR) (355) (355BK) (355BR) (356) (356BK) (356BR) (358).

Ventilator shall have metal blade and flashing plate. Bird screen to be included.

Dome to be ultraviolet resistant plastic. (.050 Approx. 18 gage aluminum). Motor to be thermally protected and permanently lubricated. RPM not to exceed 1000 (Models 350, 350BK, 350BR), 1100 (Models 355, 355BK, 355BR, 358), 1500 (Models 356, 356BK, 356BR).

Ventilator shall have a built-in adjustable thermostat and mount easily between rafters or wall studs.

Air delivery shall be no less than 1050 CFM (Models 350, 350BK, 350BR), 1200 CFM (Models 355, 355BK, 355BR, 358), 1600 CFM (Models 356, 356BK, 356BR). All ratings shall be certified by HVI. Units to be U.L. Listed.

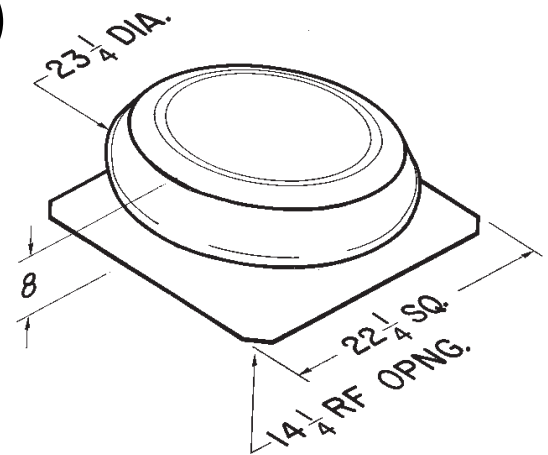

Broan-NuTone LLC Hartford, Wisconsin www.broan.com 800-558-1711

REFERENCE	QTY.	REMARKS	Project
			Location
			Architect
			Engineer
			Contractor
			Submitted by Date