

This Owner's Manual is provided and hosted by [Appliance Factory Parts](#).

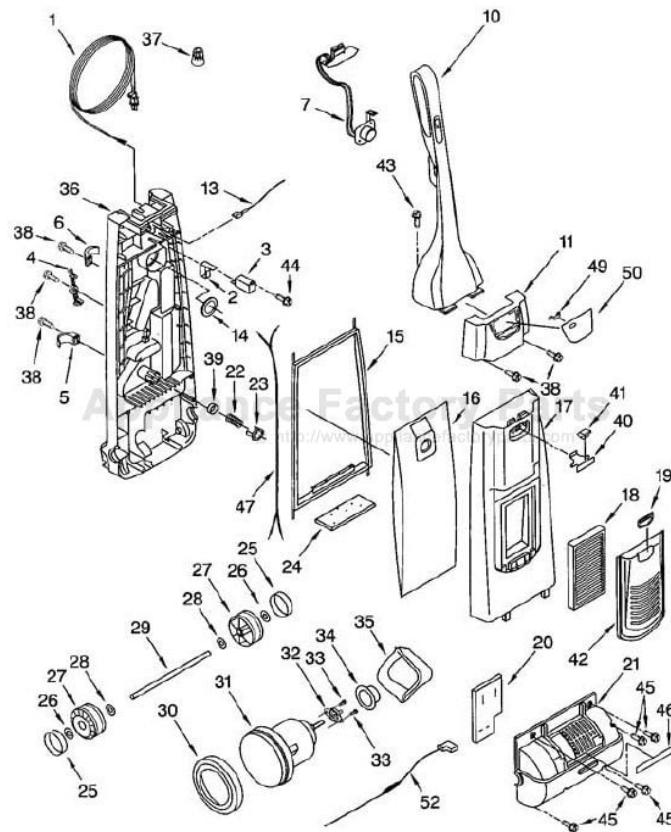

# Kenmore 116.33612300 Owner's Manual

[Shop genuine replacement parts for Kenmore  
116.33612300](#)



[Find Your Kenmore Vacuum Cleaner Parts - Select From 746 Models](#)

----- Manual continues below part list -----

## Available Replacement Parts for Kenmore 116.33612300

<a href="#">5240</a>	LIGHT BULB
<a href="#">8192015</a>	AGITATOR VA
<a href="#">KER-1820</a>	SAFETY FILTER
<a href="#">PR-1015</a>	BELT, FLAT, UPRIGHTS, 1 PACK
<a href="#">KER-1800</a>	FILTER VA

# Owner's Manual



Model	116.30612
	116.31412
	116.31512
	116.31612
	116.31612A
	116.31613
	116.32612
	116.32613
	116.33612
	116.33613
	116.34612
	116.34613

## CAUTION:

Read and follow all safety and operating instructions before first use of this product.



## TABLE OF CONTENTS

<b>Before Using Your New Vacuum</b> .....	2	<b>Vacuum Cleaner Care</b> .....	13
<b>Kenmore Vacuum Cleaner Warranty</b> .....	2	Vacuum Storage .....	13
<b>Important Safety Instructions</b> .....	3	Cleaning Exterior and Attachments .....	13
<b>Parts and Features</b> .....	4	Dust Bag Changing .....	14
<b>Assembly Instructions</b> .....	5-6	Filter Changing .....	15
<b>Operating Instructions</b> .....	6	Belt Changing and Agitator Cleaning ..	16-18
Pile Height Selection and Setting .....	7	Clog Removal .....	19
Carpet/Bare Floor Selector .....	7	Light Bulb Changing .....	20
Releasing the Handle .....	8	Agitator Servicing .....	21
ON/OFF Switch .....	8	Agitator Assembly .....	21
Attachments .....	8-10	<b>Troubleshooting</b> .....	22
Attachment Use Chart .....	10	<b>Requesting Assistance</b>	
Vacuuming Tips .....	11	<b>Or Service</b> .....	Back Page
Performance Features .....	11-12		

## BEFORE USING YOUR NEW VACUUM

Please read this guide. It will help you assemble and operate your new Kenmore vacuum in the safest and most effective way.

For more information about vacuum cleaner care and operation, call your nearest Sears store. You will need the complete model and serial numbers when requesting information. Your vacuum's model and serial numbers are located on the Model and Serial Number Plate.

Use the space below to record the model number and serial number of your new Kenmore vacuum.

Model No. \_\_\_\_\_

Serial No. \_\_\_\_\_

Date of Purchase \_\_\_\_\_

Keep this book and your sales check (receipt) in a safe place for future reference.

## KENMORE VACUUM CLEANER WARRANTY

### LIMITED ONE YEAR WARRANTY ON KENMORE VACUUM CLEANER

This warranty is for one year from the date of purchase, and includes only private household vacuum cleaner use. During the warranty year, when this vacuum cleaner is operated and maintained according to the owner's manual instructions, Sears will repair any defects in material or workmanship free of charge.

This warranty excludes vacuum bags, belts, light bulbs, and filters, which are expendable parts and become worn during normal use.

**For warranty service, return this vacuum cleaner to the nearest Sears Service Center in the United States.**

This warranty applies only while this product is in use in the United States. This warranty gives you specific legal rights, and you may also have other rights which vary from state to state.

# IMPORTANT SAFETY INSTRUCTIONS



## WARNING

Your safety is important to us. To reduce the risk of fire, electrical shock, injury to persons or damage when using your vacuum cleaner, follow basic safety precautions including the following:

**Read** this manual before assembling or using your vacuum cleaner.

**Use** your cleaner only as described in this manual. Use only with Sears recommended attachments.

To reduce the risk of electrical shock – **Do not** use outdoors or on wet surfaces.

**Disconnect** electrical supply before any servicing or cleaning. Failure to do so could result in electrical shock or personal injury.

**Always** turn cleaner off before unplugging.

**Do not** unplug by pulling on cord. To unplug, grasp the plug, not the cord.

**Do not** use with damaged cord or plug. If cleaner is not working as it should, has been dropped, damaged, left outdoors, or dropped into water, return it to a Sears Service Center.

**Do not** pull or carry by cord, use cord as a handle, close door on cord, or pull cord around sharp edges or corners. **Do not** run cleaner over cord. Keep cord away from heated surfaces.

**Do not** leave cleaner when plugged in. Unplug from outlet when not in use and before servicing.

**Do not** allow to be used as a toy. Close attention is necessary when used by or near children.

**Do not** handle plug or cleaner with wet hands.

**Do not** put any objects into openings.

**Do not** use with any opening blocked; keep free of dust, lint, hair and anything that may reduce air flow.

**Keep** hair, loose clothing, fingers, and all parts of body away from openings and moving parts.

**Do not** use cleaner without dust bag and/or filters in place.

**Always** change the dust bag after vacuuming carpet cleaners or freshener, powders and fine dust. These products clog the bag, reduce airflow and can cause the bag to burst. Failure to change bag could cause permanent damage to the cleaner.

**Do not** use the cleaner to pick up sharp hard objects, small toys, pins, paper clips, etc. They may damage the cleaner or dust bag.

**Do not** pick up anything that is burning or smoking, such as cigarettes, matches, or hot ashes.

**Do not** use cleaner to pick up flammable or combustible liquids (gasoline, cleaning fluids, perfumes, etc.), or use in areas where they may be present. The fumes from these substances can create a fire hazard or explosion.

**Use extra care** when cleaning on stairs. Do not put on chairs, tables, etc. Keep on floor.

**You are responsible** for making sure that your vacuum cleaner is not used by anyone unable to operate it properly.

## SAVE THESE INSTRUCTIONS

Proper assembly and safe use of your vacuum cleaner are your responsibilities. Your cleaner is intended only for household use. Read this Owner's Manual carefully for important use and safety information. This guide contains safety statements under warning and caution symbols. Please pay special attention to these boxes and follow any instructions given. **WARNING** statements alert you to such dangers as fire, electrical shock, burns and personal injury. **CAUTION** statements alert you to such dangers as personal injury and/or property damage.

## PARTS AND FEATURES

It is important to know your vacuum cleaner's parts and features to assure its proper and safe use. Review these before using your cleaner.

Item	Part No. In U.S.	Part No. In Canada
Dust Bag	20-50690	20-50690C
Headlight Bulb	20-5240	20-40600
Belt	20-5275	20-40096
Exhaust Filter	20-86889	20-86889C
Motor Safety Filter	20-86884	20-86884C

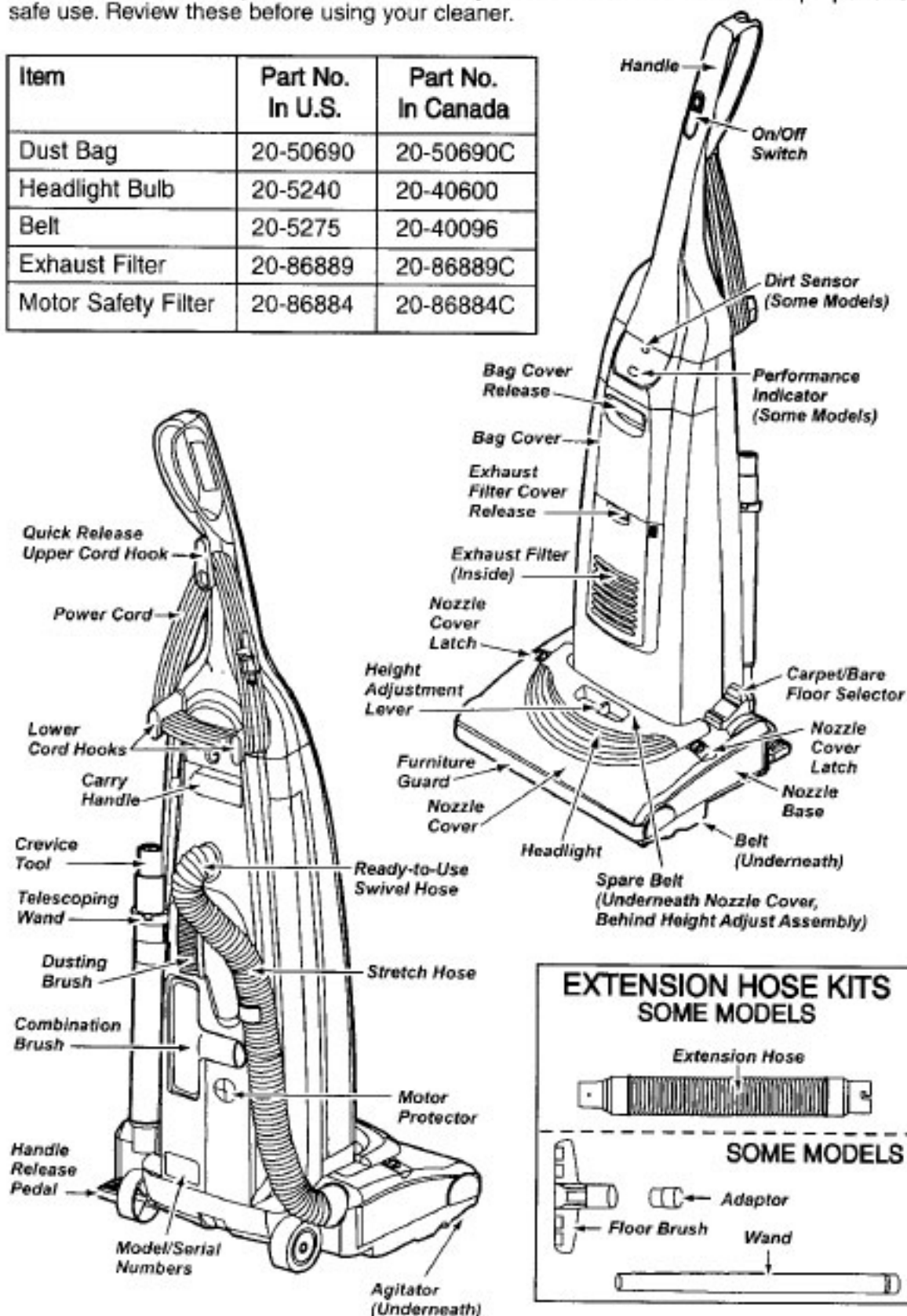

## ASSEMBLY INSTRUCTIONS



### WARNING

#### Electrical Shock Hazard

Do not plug into the electrical supply until the assembly is complete. Failure to do so could result in electrical shock or injury.

Before assembling vacuum, check the **PACKING LIST** on the cover of the separate Repair Parts List. Use this list to verify that you have received all the components of your new Kenmore vacuum.

Remove the tape located below the dust cover/filter cover on the motor case.

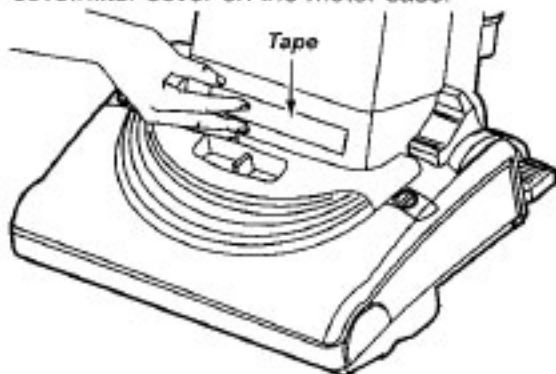

Attach stretch hose end to nozzle as shown.



### HANDLE ASSEMBLY

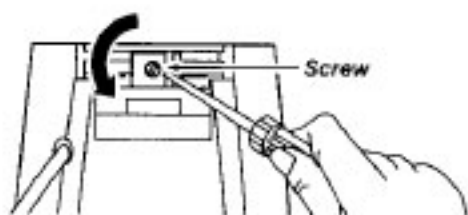

Remove the screw located just below the top edge of the back of the vacuum.

Position the handle as shown in the illustration below.

Slide the handle into the opening at the top of the vacuum.

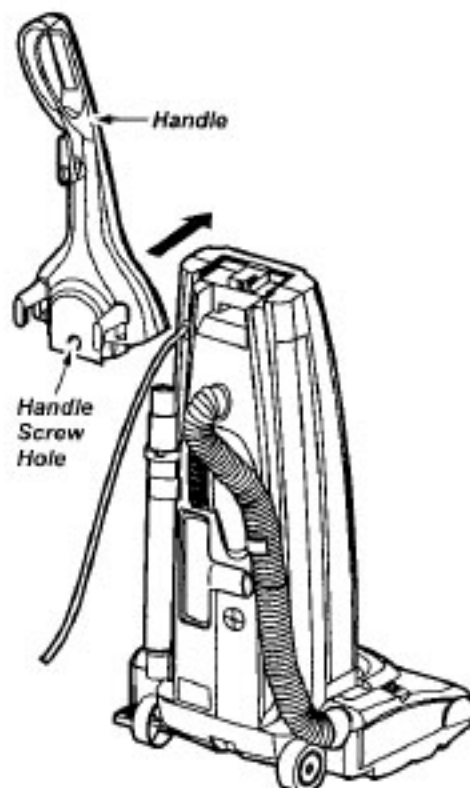

Insert the screw so it passes through the handle into the vacuum.

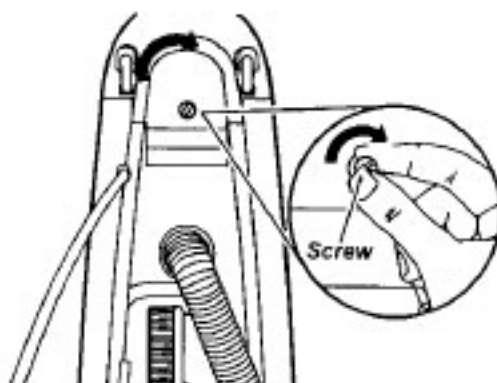

Begin to tighten the screw with your fingers. It may be necessary to adjust the handle slightly.

Using a screwdriver, tighten the screw.

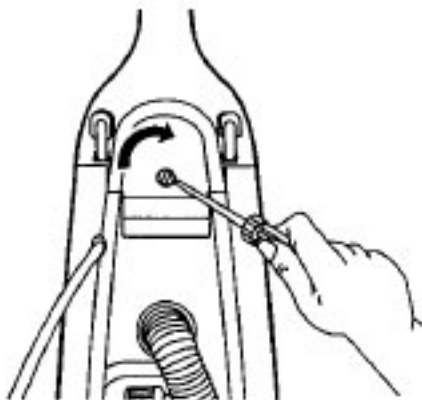

## CAUTION

- Do not overtighten. Overtightening could strip the screw holes.
- Do not operate the cleaner without the screw in place.

## CORD ASSEMBLY

Make sure the quick release upper cord hook is in the upright position. Remove the wire tie from the power cord.

Lock the cord into place by forcing it into the locking notch on the body of the quick release upper cord hook as shown. This helps keep the power cord out from under the vacuum cleaner agitator.

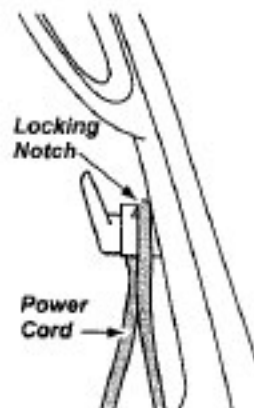

Wrap the power cord around the upper and lower cord hooks and lock the power cord plug onto the power cord.

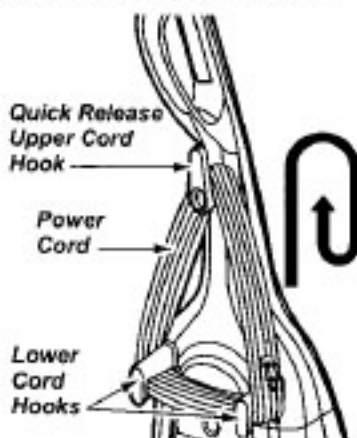

## OPERATING INSTRUCTIONS

### HOW TO START

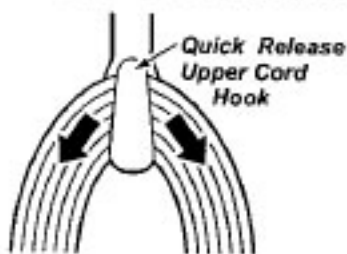

1. Turn the quick release upper cord hook to either side and down to release the power cord.
2. Release the power cord plug from the power cord and pull the cord off the quick release upper cord hook. Check to be sure the power cord is still locked into the lock in the quick release upper cord hook.
3. Check to see if the cleaner has bag installed. See DUST BAG CHANGING.

**NOTE:** To reduce the risk of electric shock, this vacuum cleaner has a polarized plug, one blade is wider than the other.

This plug will fit in a polarized outlet only one way. If the plug does not fit fully in the outlet, reverse the plug. If it still does not fit, contact a qualified technician to install the proper outlet. Do not change the plug in any way.

4. Plug the polarized power cord into a 120 Volt outlet located near the floor.



## WARNING

**Personal Injury and Product Damage Hazard**

- DO NOT plug in if switch is in the ON position. Personal injury or damage could result.
- DO NOT use outlets above counters. Damage to items in surrounding area could occur.

## PILE HEIGHT SELECTION AND SETTING

### To select a pile height setting:

Turn off cleaner. Select a pile height setting by tilting the cleaner back until front wheels are lifted slightly off the floor as illustrated.

Slide the adjustment lever to the correct setting.

### SUGGESTED PILE HEIGHT SETTINGS

You may need to raise the height to make some jobs easier, such as scatter rugs and longer pile carpets. Suggested settings are:

**HIGH:** shag carpet, long pile, plush, scatter rugs.

**MED:** medium to long pile.

**LOW:** short to medium pile.

**EX LOW:** very low pile.

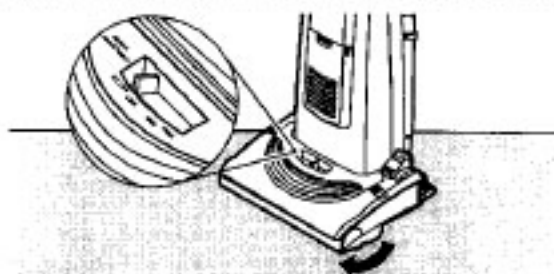

### WARNING

#### Personal Injury Hazard

**DO NOT** place hands or feet underneath the unit when changing from the bare floor to the carpet pile height setting. The agitator begins to revolve rapidly when the vacuum is turned on and is in the carpet setting.

## CARPET/BARE FLOOR SELECTOR

### SOME MODELS

**Bare floor setting:** Slide the carpet/bare floor selector all the way back and down toward the bottom of the nozzle until it locks into place.

In this position the brush assembly does not revolve. This setting should be used for cleaning hardwood and tile floors and **when any attachments (tools) are used.**

**Carpet setting:** Slide the selector **all the way forward** and up to the carpet position.

In this position the brush assembly will turn. When carpets are being cleaned the selector should be in this position.

**Attention:** Refer to your carpet manufacturers cleaning recommendations. Some more delicate carpets may require that they be vacuumed with the agitator turned off, to prevent carpet damage.



### CAUTION

Do not allow vacuum cleaner to remain in one spot for any length of time when the agitator is turning. Damage to carpet may occur.

**NOTE:** For longer belt life, turn vacuum off before moving selector, otherwise make sure the selector is pushed **fully and quickly as possible** to the desired position. Failure to do so can cause the belt to rub on the selector shaft and may result in the belt becoming hot and creating a burning rubber smell.

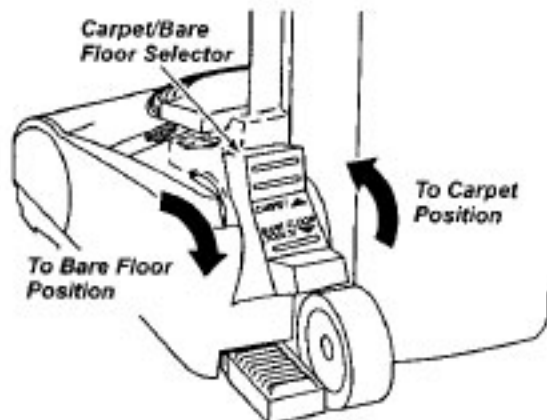

## RELEASING THE HANDLE

Release the handle by pressing down on the handle release pedal with your foot and pulling back and down on the handle with your hand.



## ON/OFF SWITCH

### HANDLE MOUNTED SOME MODELS

To start the vacuum cleaner, slide the On/Off switch from the OFF position to the ON position. To stop the vacuum cleaner, slide the On/Off switch to the OFF position.

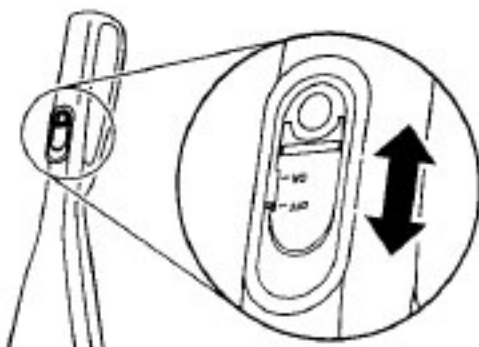

## ATTACHMENTS

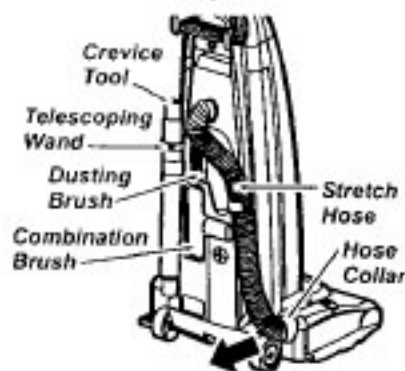

Identify each of the attachments shown above.

### TO USE ATTACHMENTS

Place the carpet/bare floor selector in the bare floor setting by rotating the selector back and down to the bare floor setting. See CARPET/BARE FLOOR SELECTOR section.

When returning the bare floor selector to the carpet setting, use caution as the selector can move quickly to that setting due to tension created by the belt.

Remove the lower end of the stretch hose from the cleaner by grasping the hose collar, twisting and pulling straight out. The attachments can now be added to the hose.

**NOTE:** The motor protector may open when using attachments or when cleaning new carpet, due to reduced airflow by the attachments themselves or by new carpet fuzz filling the bag quickly. See the TROUBLESHOOTING section.



### WARNING

#### Electrical Shock And Personal Injury Hazard

Disconnect electrical supply before servicing or cleaning the unit. Failure to do so could result in electrical shock or personal injury from cleaner suddenly starting.

The attached hose swivels to make cleaning easier in every direction. Remove the hose from the hose clip by pulling straight out.

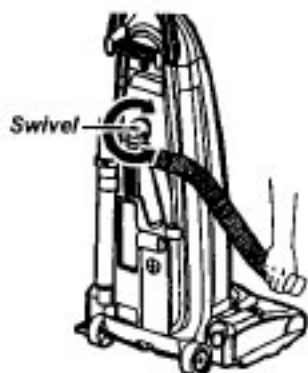

## TELESCOPING WAND WITH SUCTION CONTROL SLIDE

SOME MODELS

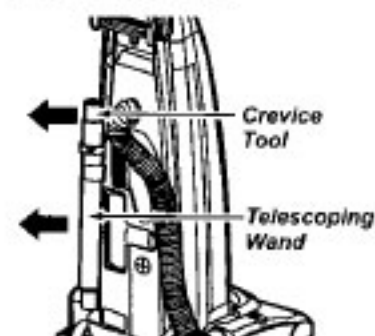

Remove the telescoping wand from its storage position.

Remove the crevice tool from its storage position in the wand. Turn the locking ring to the **UNLOCK** position.

Extend the wand to its full length. Turn the locking ring to the **LOCK** position. Attach the extension wand onto the open end of the hose.

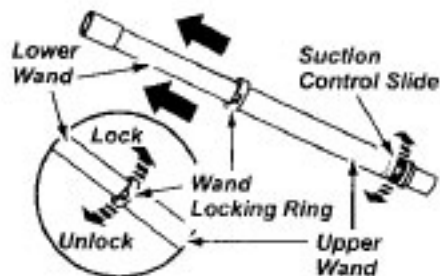

Align the tabs on the extension wand with the "J" slots in the hose. Push the wand into the hose and twist to the right to lock.

To achieve maximum reach with the attachments, add the crevice tool to the end of the wand by inserting and twisting slightly.

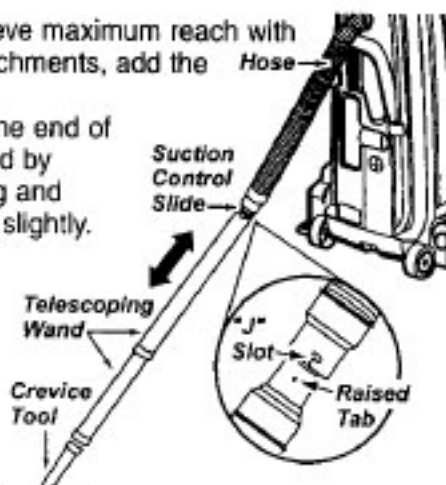

When using the dusting brush or the combination brush, they may be attached directly to the wand or placed on the end of the crevice tool.

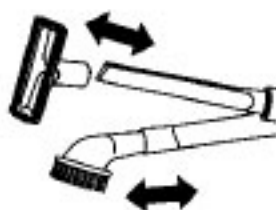

## TO OPERATE SUCTION CONTROL SLIDE

Telescoping Wand

When using attachments for cleaning draperies, small rugs with low pile and other delicate items, twist

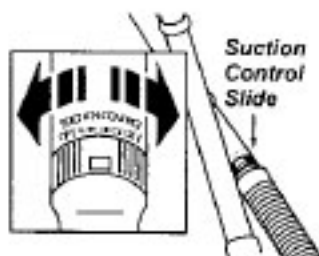

the suction control slide to the open position. This lever is located on the telescoping wand, close to the hose. This will reduce suction for ease of cleaning.

**NOTE:** Return suction control slide to the closed position for normal cleaning.



## CAUTION

When using attachments, be careful not to overextend the stretch hose when reaching. Trying to reach beyond the hose stretch capability could cause the cleaner to tip over. Make sure the carpet/bare floor selector is in the bare floor position. Damage to the floor surface may occur if the carpet setting is used.

## TO STORE ATTACHMENTS

Remove dusting brush or combination brush. Snap into appropriate storage location.

Remove crevice tool from the wand by twisting. Lay aside.

Remove the extension wand from the hose. Twist the wand to the left and pull from the hose end.

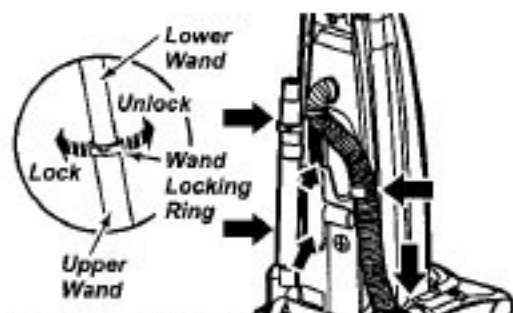

Unlock the wand by turning the wand locking ring to the **UNLOCK** position.

Slide the lower wand into the upper wand. Turn the wand locking ring to the **LOCK** position.

Place the crevice tool down into the compressed wand. Snap into the appropriate storage location.

Reinsert the hose fully into the opening on the lower body from which it was removed. Press firmly to assure connection.



### CAUTION

**DO NOT** pull the vacuum cleaner around the room by the hose. Property damage could result.

## EXTENSION HOSE

### SOME MODELS

Some models include an extra hose which connects to the stretch hose on the vacuum for a longer cleaning reach.



Insert the two tabs on the end of the extension hose into the two "J" shaped slots on the unit hose and twist to connect.

All attachments and the telescoping wand can be attached to the open end of the hose.

## FLOOR BRUSH AND WAND

### SOME MODELS

Some models have an extra brush and wand for cleaning bare floors. Twist one end of the adaptor into the floor brush and the other end into the straight wand. Connect the straight wand to the telescopic wand and then to the vacuum hose or extension hose.

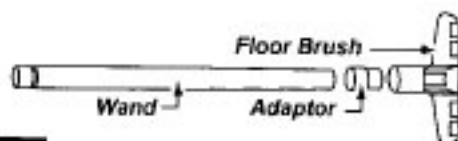





### CAUTION

When using the regular hose or with the extension hose attached, the cleaner should be on a solid surface on the same level or below the level of the user's feet. **DO NOT** use the hoses when the cleaner is above the level of the user's feet.

## ATTACHMENT USE CHART

### CLEANING AREA

ATTACHMENT	Furniture*	Between Cushions*	Drapes*	Stairs	Walls
DUSTING BRUSH 	X		X		X
CREVICE TOOL 	X	X		X	
COMBINATION BRUSH 	X		X	X	
Handi-Mate® Jr. 	X			X	

\*Always clean attachments before using on fabrics.

## VACUUMING TIPS

### Carpet edges.

Guide either side or the front of the nozzle along a baseboard. The full length brushes help remove dirt at carpet edges.

### Stairs.

Put handle in full upright position. Place the carpet/bare floor selector in the bare floor position. Use the crevice tool or fabric brush. Set the On/Off switch to ON.



## WARNING

### Personal Injury Hazard

Use care if vacuum cleaner is placed on stairs. If it falls, personal injury or property damage could result.

For best cleaning results, keep the airflow passage clear.

Occasionally, check each of the areas indicated for clogs.

Unplug the cleaner from the outlet before checking.



## PERFORMANCE FEATURES

### MOTOR PROTECTION SYSTEM

This vacuum has a motor protector by-pass valve which automatically opens to provide cooling air to the motor when a clog prevents the normal flow of air to the motor. If the by-pass valve opens to prevent motor overheating and possible damage to the vacuum, you will notice a change of sound as air rushes through the valve opening.

**NOTE:** Do not block motor protector

**To correct problem:** See the TROUBLE-SHOOTING chart.

**NOTE:** The motor protector may open when using attachments or when cleaning new carpet, due to reduced airflow by the attachments themselves or by new carpet fuzz filling the bag quickly. See the TROUBLESHOOTING section.



Motor Protector

### PERFORMANCE INDICATOR SOME MODELS

When the unit is running with normal airflow, the light on the performance indicator is off. The light comes on whenever the airflow becomes blocked. If that occurs, check the disposable dust bag, motor safety filter and other possible clog locations shown in CLOG REMOVAL.

**To correct problem:** See the TROUBLE-SHOOTING chart.

**NOTE:** The light may also come on when using attachments, due to reduced airflow through the attachment.

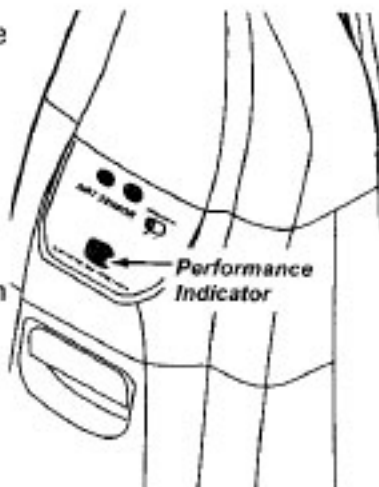

## DIRT SENSOR SOME MODELS

The electronic dirt sensor is a feature which will detect particles as they pass through the vacuum cleaner.

The dirt sensor indicator is located on the front of the switch cover.

The red light indicates dirt is being picked up by the cleaner.

## OPERATION

As you vacuum, the red indicator light will come on and stay on as long as the sensor detects a high concentration of particles passing through the cleaner.

No light indicates that most of the cleaning is complete.

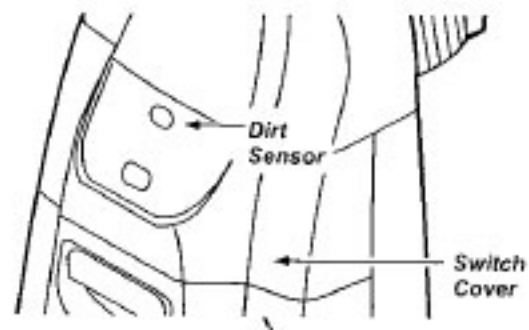

## WARNING

### Electrical Shock And Personal Injury Hazard

Disconnect electrical supply before servicing or cleaning the unit. Failure to do so could result in electrical shock or personal injury from cleaner suddenly starting.

## TO CLEAN DIRT SENSOR OPTICS

The dirt sensor optics consist of two optic cells located inside the bag holder. Occasionally, it may become necessary to clean the two optic cells to assure maximum performance. It is recommended the optic cells be cleaned:

- When the red light stays on continuously.
- When dirt or dust adheres to the optic cells.
- Whenever the dust bag is changed.

To clean the sensor, wipe the optic cells with a soft, dry cloth. Never use cleaners or liquids as they can help speed the recoating of the optic cells and make it necessary to clean them much sooner than normal. The dirt sensor area can be reached by removing the dust cover and the dust bag.

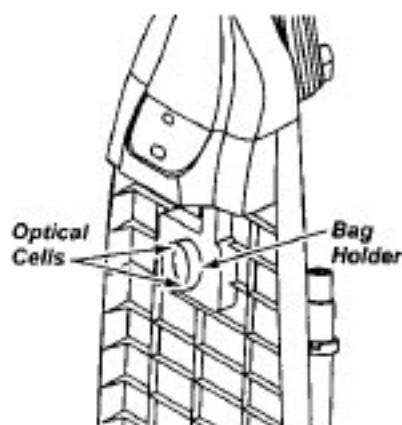

## VACUUM CLEANER CARE

Always follow all safety precautions when cleaning and servicing the vacuum cleaner.



### WARNING

**Electrical Shock And Personal Injury Hazard**

Disconnect electrical supply before servicing or cleaning the unit. Failure to do so could result in electrical shock or personal injury from cleaner suddenly starting.

## VACUUM STORAGE

Gather the cord and wrap it loosely around the upper and lower cord hooks.

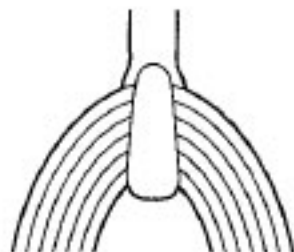

Store the cleaner in a dry, indoor area, on the floor with the handle locked in the upright position.



### WARNING

**Electrical Shock And Personal Injury Hazard**

Wrapping the cord too tightly puts stress on the cord and can cause cord damage. A damaged cord is an electrical shock hazard and could cause personal injury or damage.

## CLEANING EXTERIOR AND ATTACHMENTS

Unplug cord from wall outlet. **DO NOT** drip water on cleaner.

Clean exterior using a clean, soft cloth that has been dipped in a solution of mild liquid detergent and water, then wrung dry. Wipe dry after cleaning.

To reduce static electricity and dust build-up, wipe outer surface of cleaner and attachments.

Wash attachments in warm soapy water, rinse and air dry. **Do not clean in dishwasher.**



### CAUTION

Do not use attachments if they are wet. Attachments used in dirty areas, such as under a refrigerator, should not be used on other surfaces until they are washed. They could leave marks.

## DUST BAG CHANGING

### TO REMOVE DUST BAG



#### WARNING

Always unplug power cord from electrical outlet before performing any service on vacuum.

Pull out on the bag cover release located near the top of the bag cover.



Pull the bag cover forward and lift up. Remove and lay aside.

Grasp the dust bag collar and pull gently, carefully removing the dust bag.



Throw away the used dust bag.

Do not reuse.



Bag Holder  
Bag Cavity  
Motor Safety Filter

Check the bag holder and the motor safety filter. If either is blocked, check TROUBLE-SHOOTING.



#### CAUTION

NEVER REUSE A DUST BAG. Very fine materials, such as carpet freshener, face powder, fine dust, plaster, soot, etc. can clog the bag and cause it to burst before it is full. Change bag more often when vacuuming these materials.

### TO REPLACE DUST BAG

Unfold the new dust bag. Fold the safety seal tab on the new dust bag away from the opening that fits on the bag holder.



**NOTE:** See PARTS AND FEATURES for Bag number.



Insert the dust bag onto the bag holder completely by holding the bag collar.

Place the dust bag collar into position.

Tuck the bag behind each of the four bag retention corner flaps shown here. Be sure the bottom and sides of the dust bag are completely within bag cavity prior to replacing the bag cover.

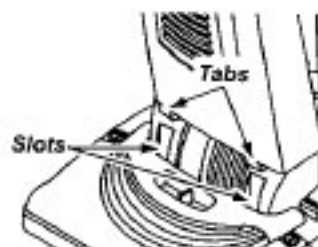
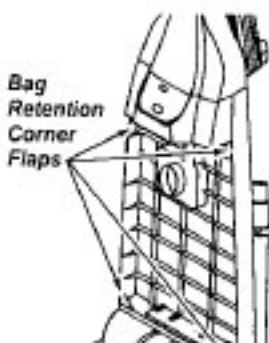

Position the bag cover so its positioning tabs fit into the body positioning tab slots.

Close the bag cover.

You will hear a distinct snap when cover is securely closed.



Check to see that the dust bag is fully enclosed in the bag cover.

## FILTER CHANGING

Check motor safety filter frequently and change when dirty.



### WARNING

#### Electrical Shock Hazard

Unplug power cord from electrical outlet. Do not operate the cleaner without the motor safety filter. Be sure the filter is dry and properly installed to prevent motor failure and/or electrical shock.

Remove the dust bag as outlined in the DUST BAG CHANGING section.

### MOTOR SAFETY FILTER ELECTROSTATIC

1. This white & grey filter must be replaced when dirty. It should be replaced regularly depending on use conditions. **The filter CANNOT be washed as it will lose its dust trapping ability.**

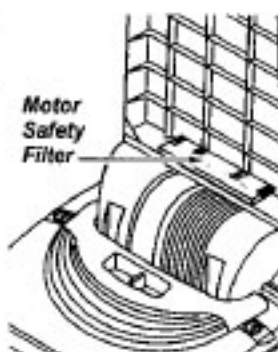

**NOTE:** See PARTS AND FEATURES for motor safety filter number.



2. If the filter, located in the bottom of the bag cavity, is dirty, remove it by pulling forward out from under the ribs.

3. Replace the filter, **white side up**, by sliding it back into place under the ribs in the bag cavity.

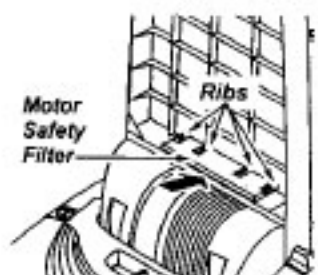

Replace the bag as outlined in the DUST BAG CHANGING section.



### WARNING

Do not operate without exhaust filter.

### EXHAUST FILTER

#### HEPA

The exhaust filter cartridge must be replaced when dirty. It should be replaced regularly depending on use conditions. **The filter CANNOT be washed as it will lose its dust trapping ability.**

**NOTE:** See PARTS AND FEATURES for the exhaust filter number.

Slide the exhaust filter cover release down. Pull out on exhaust filter cover to remove from bag cover.

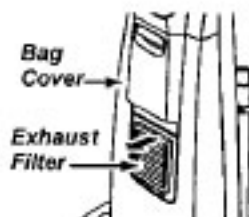
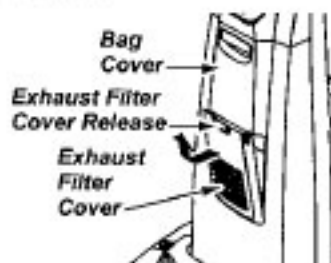

Remove the exhaust filter cartridge from the bag cover.

Replace the exhaust filter cartridge, carefully positioning it so that it fits into the bag cover. **The grey edge of the filter should be facing away from the operator.** Push only on filter cartridge frame, not on filter itself.

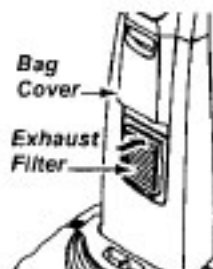

Replace the exhaust filter cover and secure the latch by pushing it upward.

## BELT CHANGING AND AGITATOR CLEANING



### WARNING

**Electrical Shock Or Personal Injury Hazard**

Disconnect electrical supply before servicing or cleaning the unit. Failure to do so could result in electrical shock or personal injury from cleaner suddenly starting.

Frequently check and remove hair, string and lint build-up in the brush area. If build-up becomes excessive, follow the steps below.

### TO REMOVE BELT

Disconnect power cord from electrical outlet.

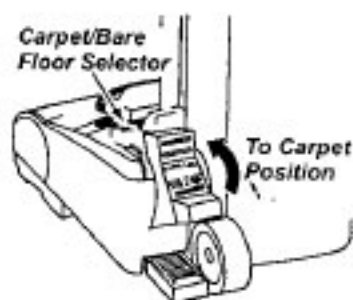

Place the carpet/bare floor selector in the carpet position.

Slide latches outward and remove nozzle cover.

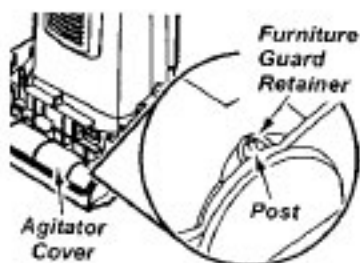
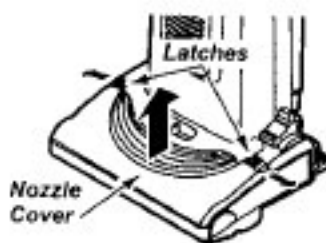

Unfasten the furniture guard retainers from the posts on both sides of the agitator cover.

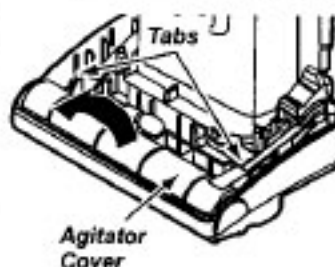

Depress tabs on rear of agitator cover and rotate forward to release from the nozzle body.

The light bulb socket assembly does not have to be removed. Lay the agitator cover over to the side out of the way.

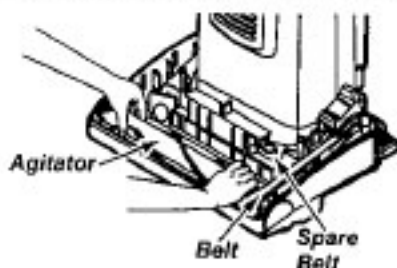

Position hands on the agitator. If the belt is still attached to the agitator, there will be tension on the agitator. Carefully lift the right end of the agitator and then the left end.

**NOTE:** It may be necessary to pull the edge of the furniture guard out of the way to allow the ends of the agitator to be removed easily.

Remove the belt from the motor drive shaft.

A spare belt is provided. See above illustration for location of spare belt. You may keep a spare belt in this location any time.



### WARNING

**Personal Injury Hazard**

Be careful when removing the agitator as the belt tension is high. Failure to do so could result in personal injury from the agitator releasing quickly and snapping away.

## TO CLEAN AGITATOR

**NOTE:** In order to keep cleaning efficiency high and to prevent damage to your vacuum, the agitator must be cleaned every time the belt is changed.

The agitator must be cleaned according to the following schedule:

Vacuum Use	Clean Agitator
<b>HEAVY</b> (used daily)	every week
<b>MODERATE</b> (used 2-3 times/week)	every month
<b>LIGHT</b> (used 1 time/week)	every 2 months

Remove any dirt or debris in the belt path area or in the agitator area.

### Exploded View - Agitator Assembly

Carefully remove the brush end caps and remove any string or debris located on the agitator assembly, end caps, washers or agitator shaft.

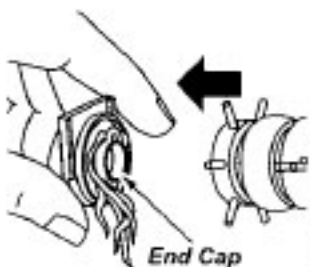
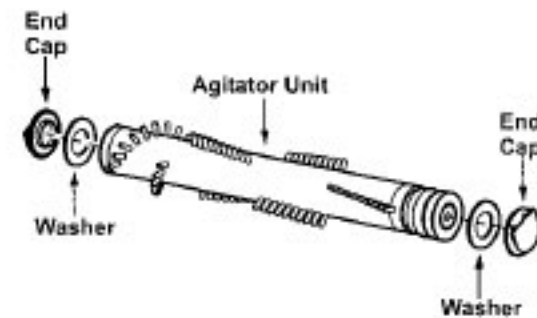

**NOTE:** Replace the end caps. See the exploded view for correct assembly.

## TO REPLACE BELT

Make sure that the carpet/bare floor selector is in the **carpet** position.

Loop the new belt on the **motor shaft**.

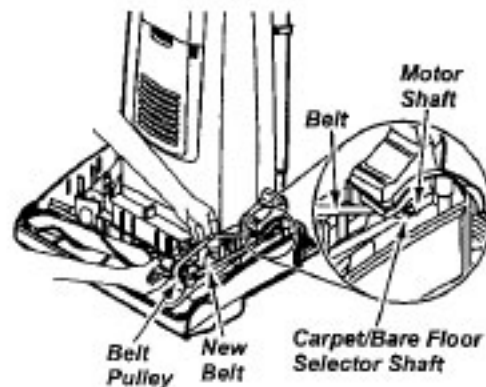

## BELT ROUTING

### Correct Routing of Belt (Selector in Carpet Position)

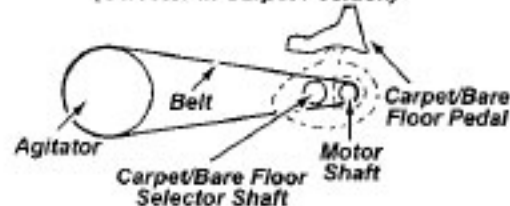

### Incorrect Routing of Belt (Belt on Selector Shaft)

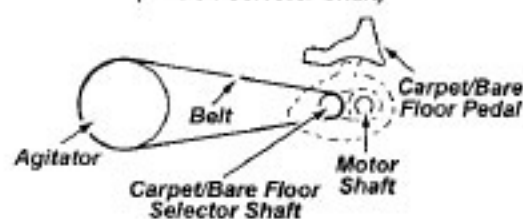

### Incorrect Routing of Belt (Selector in Bare Floor Position)

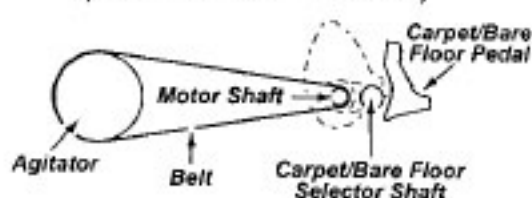

**NOTE:** See PARTS AND FEATURES for belt number.

Loop the other end of the belt on the belt pulley on the agitator.

Insert the agitator by placing the rounded portion of the end cap down into the slot in the nozzle base.

**NOTE:** It may be necessary to hold the furniture guard out of the way in order to allow proper insertion of the agitator into the nozzle base.

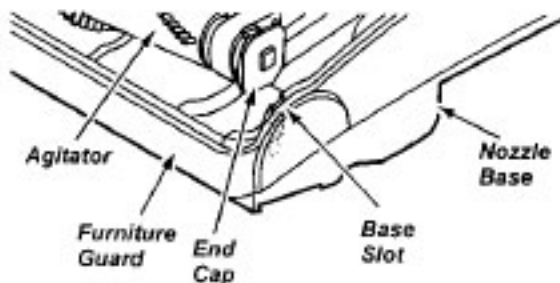

**NOTE:** Care must be taken due to the belt tension during reassembly.

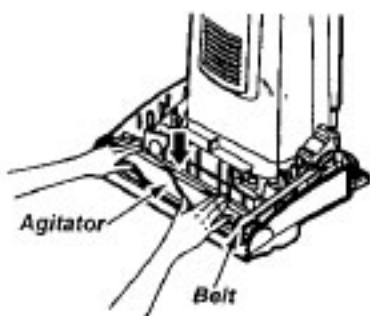

Press firmly, checking to see that each end is completely inserted.

Check to see that the belt is centered on the belt pulley. Turn the agitator with your fingers to see that it turns freely.

To re-attach the agitator cover, insert the six (6) tabs into the six slots along the front edge of the nozzle base.

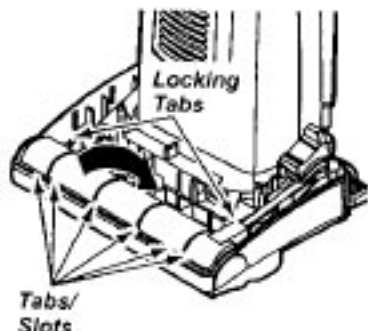

Lower the agitator cover to its original position. After positioning the agitator cover, push forward on the two (2) locking tabs in order to ensure that they are securely in place.

Re-fasten the furniture guard retainers to the posts on both sides of the agitator cover.

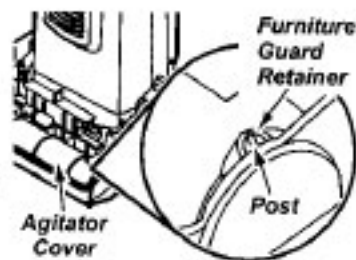

**NOTE:** If the agitator cover is not installed correctly, you may experience a loss of performance and possible agitator vibration, etc.

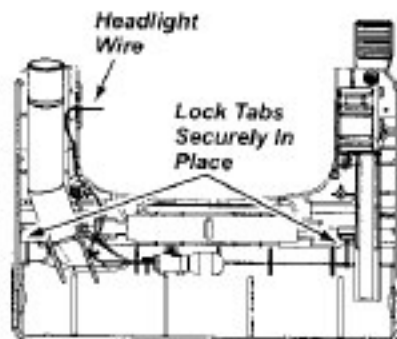

Make sure the headlight wires are tucked securely in place.

Replace the nozzle cover and secure the latches.

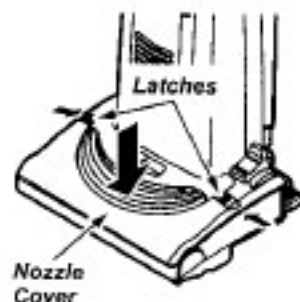

## CLOG REMOVAL

Always follow all safety precautions when cleaning and servicing the vacuum cleaner.



### WARNING

#### Electrical Shock Or Personal Injury Hazard

Disconnect electrical supply before servicing or cleaning the unit. Failure to do so could result in electrical shock or personal injury from cleaner suddenly starting.

If the cleaner does not seem to have adequate suction, first check if the dust bag is full or if a filter is clogged. See **DUST BAG CHANGING** and **FILTER CHANGING**.

If the bag and filter areas are free of clogs, check the hose area. Remove the lower end of the stretch hose from the cleaner by grasping the hose collar, twisting, and pulling straight out.



Plug in the vacuum and turn it on. Stretch the hose to maximum length and then allow the hose to return to its storage length.

Turn the unit off and unplug the unit.

Visually inspect the hose and the base area into which the hose is inserted.

Remove any visible clog.

Re-insert the hose into the opening on the lower body from which it was removed. Press firmly to assure connection.



### WARNING

#### Personal Injury Hazard

**DO NOT** place hands or feet underneath the unit at any time. The agitator will be revolving rapidly when the vacuum is turned on and is in the carpet setting.

If the bag and filter areas and the hose areas are free of clogs, check the nozzle area. To check this area, see the section on **BELT CHANGING AND AGITATOR CLEANING**.

Return the cleaner to the upright position before plugging into an electrical outlet.

## LIGHT BULB CHANGING



### WARNING

Electrical Shock Or Personal Injury Hazard

Disconnect electrical supply before servicing or cleaning the unit. Failure to do so could result in electrical shock or personal injury from cleaner suddenly starting.

### TO REMOVE LIGHT BULB

Disconnect power cord from electrical outlet.

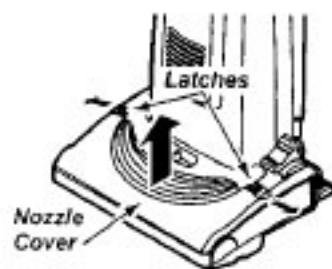

Slide latches outward and remove nozzle cover



### CAUTION

Do not use a bulb rated over 15W (130 V). During extended use, heat from the bulb could overheat surrounding plastic parts.

Remove the light bulb by pushing the bulb in while turning counterclockwise to release from the slot. Then pull the light bulb straight out.

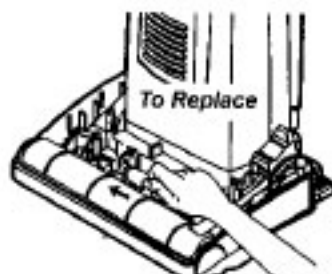
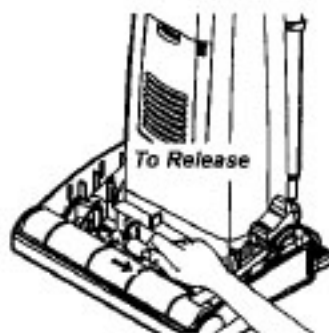

To replace the light bulb carefully insert and turn clockwise to securely fit into slot.

**NOTE:** See PARTS AND FEATURES for bulb number.



### CAUTION

Do not plug in or turn on until the vacuum is completely reassembled.

Replace the nozzle cover and secure the latches.

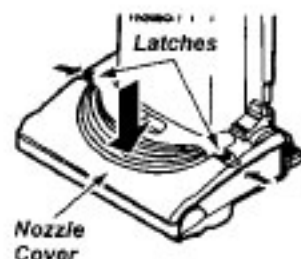

## AGITATOR SERVICING



### WARNING

Electrical Shock Or Personal Injury Hazard

Disconnect electrical supply before servicing or cleaning the unit. Failure to do so could result in electrical shock or personal injury from cleaner suddenly starting.

### TO CHECK AGITATOR

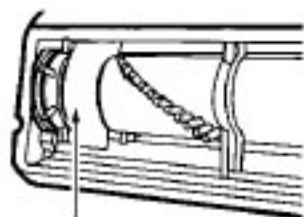

Base Plate  
Belt Guard

Turn the vacuum over to check for worn brushes. When brushes are worn to the level of the base belt guard, replace the agitator.

### TO REPLACE AGITATOR

Remove the nozzle cover, agitator cover and agitator. See BELT CHANGING AND AGITATOR CLEANING.

Remove the end caps and bearing covers.

Replace the agitator with a new one.

Replace the bearing covers and end caps.

Reassemble the belt, agitator, agitator cover and nozzle cover. See "To replace belt" in BELT CHANGING AND AGITATOR CLEANING section.

## AGITATOR ASSEMBLY

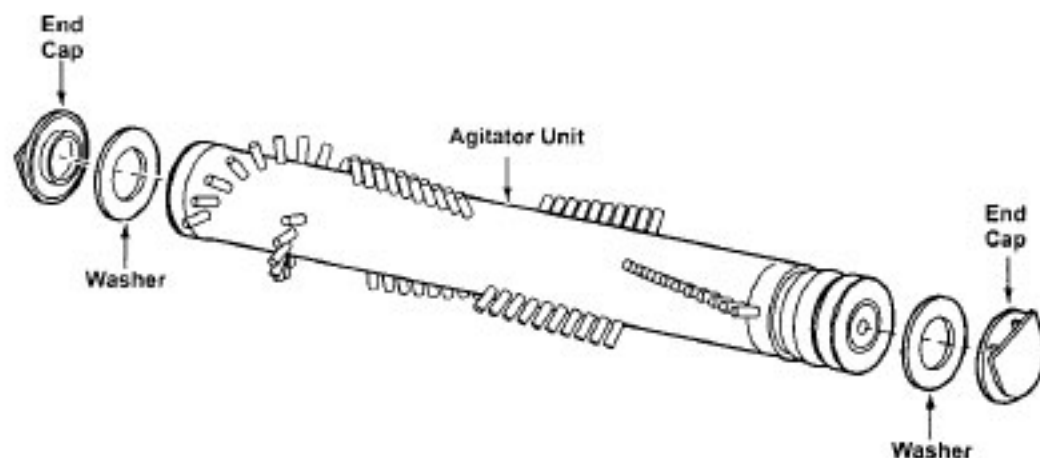

## TROUBLESHOOTING

Review this chart to find do-it-yourself solutions for minor performance problems. Any service needed, other than those described in this owner's manual, should be performed by an authorized service representative.



### **WARNING** Electrical Shock Hazard

Disconnect electrical supply before servicing or cleaning the unit. Failure to do so could result in electrical shock or personal injury.

PROBLEM	POSSIBLE CAUSE	POSSIBLE SOLUTION
Cleaner won't run.	<ol style="list-style-type: none"> <li>1. Unplugged at wall outlet.</li> <li>2. Tripped circuit breaker/blown fuse at household service panel.</li> <li>3. On/off switch not turned on.</li> </ol>	<ol style="list-style-type: none"> <li>1. Plug in firmly, push on/off switch to on.</li> <li>2. Reset circuit breaker or replace fuse.</li> <li>3. Push on/off switch to on.</li> </ol>
Poor job of dirt pick-up.	<ol style="list-style-type: none"> <li>1. Full or clogged dust bag.</li> <li>2. Wrong pile height setting.</li> <li>3. Worn agitator.</li> <li>4. Clogged nozzle or bag holder.</li> <li>5. Clogged hose.</li> <li>6. Hole in hose.</li> <li>7. Broken/misplaced belt.</li> <li>8. Hose not inserted fully.</li> <li>9. Motor protection system activated.</li> <li>10. Dirty filters.</li> </ol>	<ol style="list-style-type: none"> <li>1. Change bag, (page 14).</li> <li>2. Adjust setting, (page 7).</li> <li>3. Replace agitator, (page 21).</li> <li>4. Check CLOG REMOVAL, (page 19).</li> <li>5. Check for clogs, (page 19).</li> <li>6. Replace hose.</li> <li>7. Replace/fix belt, (page 16-18).</li> <li>8. Insert hose fully, (page 5).</li> <li>9. Check for clogs, (page 19).</li> <li>10. Change filters, (page 15).</li> </ol>
Cleaner picks up moveable rugs or pushes too hard.	<ol style="list-style-type: none"> <li>1. Wrong pile height setting.</li> </ol>	<ol style="list-style-type: none"> <li>1. Adjust setting, (page 7).</li> </ol>
Light won't work.	<ol style="list-style-type: none"> <li>1. Burned out light bulb.</li> </ol>	<ol style="list-style-type: none"> <li>1. Change light bulb, (page 20).</li> </ol>
Agitator does not turn.	<ol style="list-style-type: none"> <li>1. Broken belt.</li> <li>2. Bare floor selector in bare floor setting.</li> <li>3. Belt installed incorrectly.</li> </ol>	<ol style="list-style-type: none"> <li>1. Replace belt, (pages 16-18).</li> <li>2. Move selector to the carpet setting, (page 7).</li> <li>3. Check BELT CHANGING AND AGITATOR CLEANING, (pages 16-18).</li> </ol>
Performance indicator, some models, is red.	<ol style="list-style-type: none"> <li>1. Full or clogged dust bag.</li> <li>2. Dirty filters.</li> <li>3. Clogged airflow passage.</li> <li>4. Certain attachment tools.</li> </ol>	<ol style="list-style-type: none"> <li>1. Change bag, (page 14).</li> <li>2. Change filters, (page 15).</li> <li>3. Clear clog from airflow passage, (page 19).</li> <li>4. This is normal. Light should go off when tool is removed.</li> </ol>
Air flow restricted with attachment use. Sound changes.	<ol style="list-style-type: none"> <li>1. Attachment use restricts air flow.</li> <li>2. New carpet fuzz clogged air path.</li> </ol>	<ol style="list-style-type: none"> <li>1. Check ATTACHMENTS, (page 8)</li> <li>2. Check CLOG REMOVAL and clean hose, (page 19).</li> </ol>
Excessive noise as vacuum is shut off.	<ol style="list-style-type: none"> <li>1. Belt rubbing on carpet/bare floor selector shaft.</li> </ol>	<ol style="list-style-type: none"> <li>1. Push selector all the way forward, (page 7).</li> </ol>
Dirt Sensor, some models, will not work.	<ol style="list-style-type: none"> <li>1. Dirty optic cells.</li> </ol>	<ol style="list-style-type: none"> <li>1. Clean optic cells, (page 12).</li> </ol>