

BATH FAN UPGRADE KIT

To register this product visit:

www.broan.com

READ AND SAVE THESE INSTRUCTIONS

WARNING



TO REDUCE THE RISK OF FIRE, ELECTRIC SHOCK, OR INJURY TO PERSONS, OBSERVE THE FOLLOWING:

1. Use this unit only in the manner intended by the manufacturer. If you have questions, contact the manufacturer.
2. Before servicing or cleaning unit, switch power off at service panel. Lock or tag service panel to prevent power from being switched on accidentally.
3. Installation work and electrical wiring (including switch location) must be done by a qualified person(s) in accordance with all applicable codes and standards.
4. Provide sufficient air for proper combustion and exhausting of gases through the flue (chimney) of fuel burning equipment to prevent backdrafting. Follow the combustion equipment standards such as those published by the National Fire Protection Association (NFPA), the American Society for Heating, Refrigeration and Air Conditioning Engineers (ASHRAE), and local codes.
5. This product may have sharp edges. Be careful to avoid cuts and abrasions during installation and cleaning.
6. When cutting or drilling into wall or ceiling, do not damage electrical wiring and other hidden utilities.
7. Ducted fans must always be vented to the outdoors.
8. Not for use in kitchens.
9. Acceptable for use over a bathtub or shower when installed in a GFCI protected branch circuit.
10. This unit must be grounded.
11. This unit must be installed into fan housings that are marked "D-Housing" or "690" Series. Other fan housings cannot be substituted. For use only with Broan fan models 670, 671, 688, 689 and Nautilus fan models N671, N688 and NuTone fan models 693, 695, 696N.

CAUTION



1. For general ventilating use only. Do not use to exhaust hazardous or explosive materials and vapors.
2. Install fan at least five feet (1.52 m) above floor.
3. To avoid motor bearing damage and noisy, unbalanced impellers, keep drywall spray, construction dust, etc. off motor and impeller.
4. Read specification label on product for information and requirements.

CLEANING & MAINTENANCE

- For quiet and efficient operation, long life, and attractive appearance – lower or remove grille and vacuum interior of fan with a dusting brush attachment.
- The motor is permanently lubricated and never needs oiling. If the motor bearings make excessive or unusual noise, replace the motor with the exact service motor. The impeller should also be replaced.
- To remove blower assembly - See step 3 on page 2.

OPERATION

Use an on/off switch or speed control to operate this ventilator.

WARRANTY

BROAN ONE YEAR LIMITED WARRANTY

Broan warrants to the original purchaser of its products that such products will be free from defects in materials or workmanship for a period of one year from the date of original purchase. THERE ARE NO OTHER WARRANTIES, EXPRESSED OR IMPLIED, INCLUDING, BUT NOT LIMITED TO, IMPLIED WARRANTIES OF MERCHANTABILITY OR FITNESS FOR A PARTICULAR PURPOSE.

During this one-year period, Broan will, at its option, repair or replace, without charge, many product or part which is found to be defective under normal use and service.

THIS WARRANTY DOES NOT EXTEND TO FLUORESCENT LAMP STARTERS AND TUBES. This warranty does not cover (a) normal maintenance and service or (b) any products or parts which have been subject to misuse, negligence, accident, improper maintenance or repair (other than by Broan), faulty installation or installation contrary to recommended installation instructions.

The duration of any implied warranty is limited to the one-year period as specified for the express warranty. Some states do not allow limitations on how long an implied warranty lasts, so the above limitation may not apply to you.

BROAN'S OBLIGATION TO REPAIR OR REPLACE, AT BROAN'S OPTION, SHALL BE THE PURCHASER'S SOLE AND EXCLUSIVE REMEDY UNDER THIS WARRANTY. BROAN SHALL NOT BE LIABLE FOR INCIDENTAL, CONSEQUENTIAL OR SPECIAL DAMAGES ARISING OUT OF OR IN CONNECTION WITH PRODUCT USE OR PERFORMANCE. Some states do not allow the exclusion or limitation of incidental or consequential damages, so the above limitation or exclusion may not apply to you.

This warranty gives you specific legal rights, and you may also have other rights, which vary from state to state. This warranty supersedes all prior warranties.

To qualify for warranty service, you must (a) notify Broan at the address stated below or telephone 1-800-637-1453, (b) give the model number and part identification and (c) describe the nature of any defect in the product or part. At the time of requesting warranty service, you must present evidence of the original purchase date.

Broan-NuTone LLC, 926 West State Street, Hartford, WI 53027

INSTALLATION

1. Disconnect the electrical power supply and lock out the service panel for the existing fan.

2. Remove the grille from the existing fan.

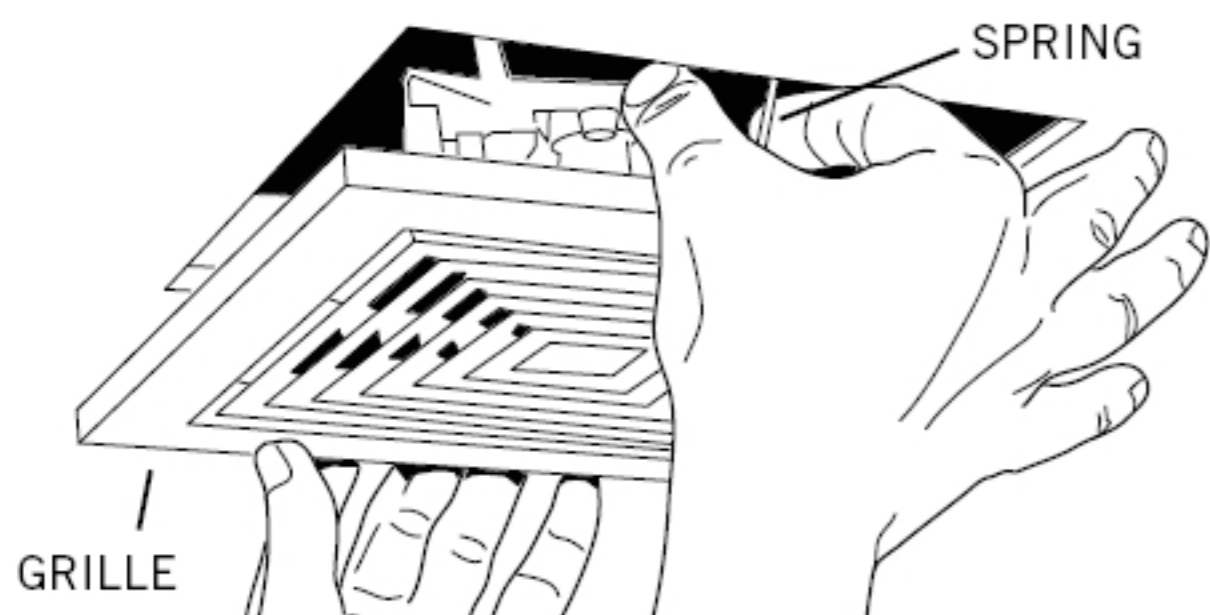

Pull grille down to expose two springs. Squeeze each spring together and pull down again to release springs from motor plate slots.

-- D-HOUSING FAN ONLY --

3. Remove blower assembly from existing fan.

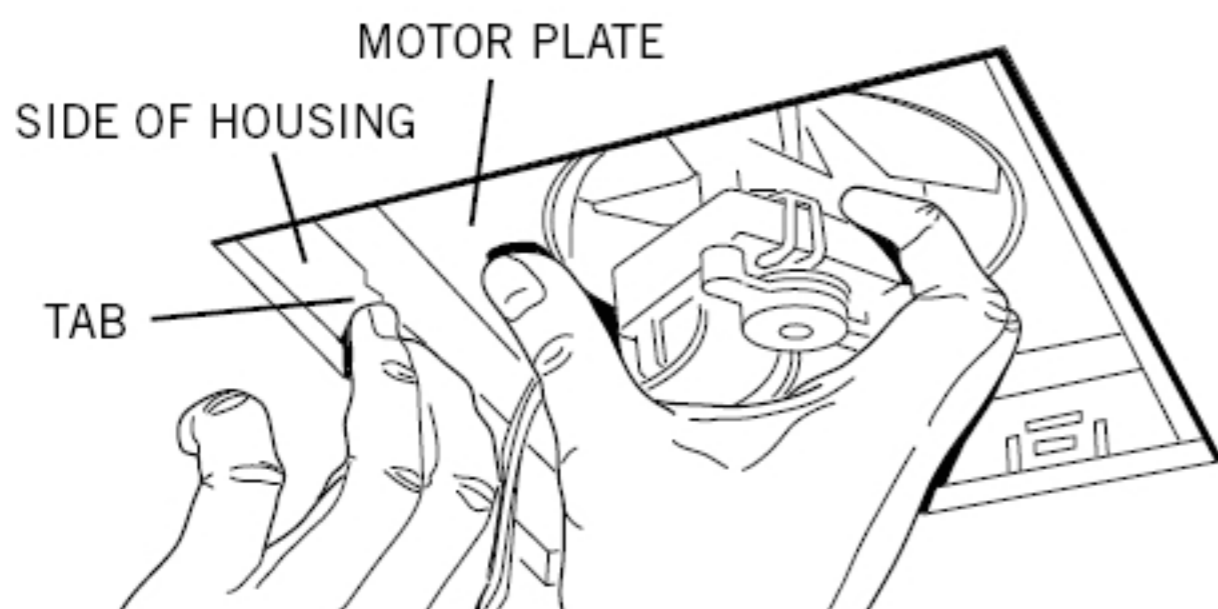

Unplug motor cord from receptacle. Find the single tab on the motor plate. Push up on motor plate near tab while pushing out on side of housing. Or insert a straight-blade screwdriver into slot in housing next to tab and twist screwdriver.

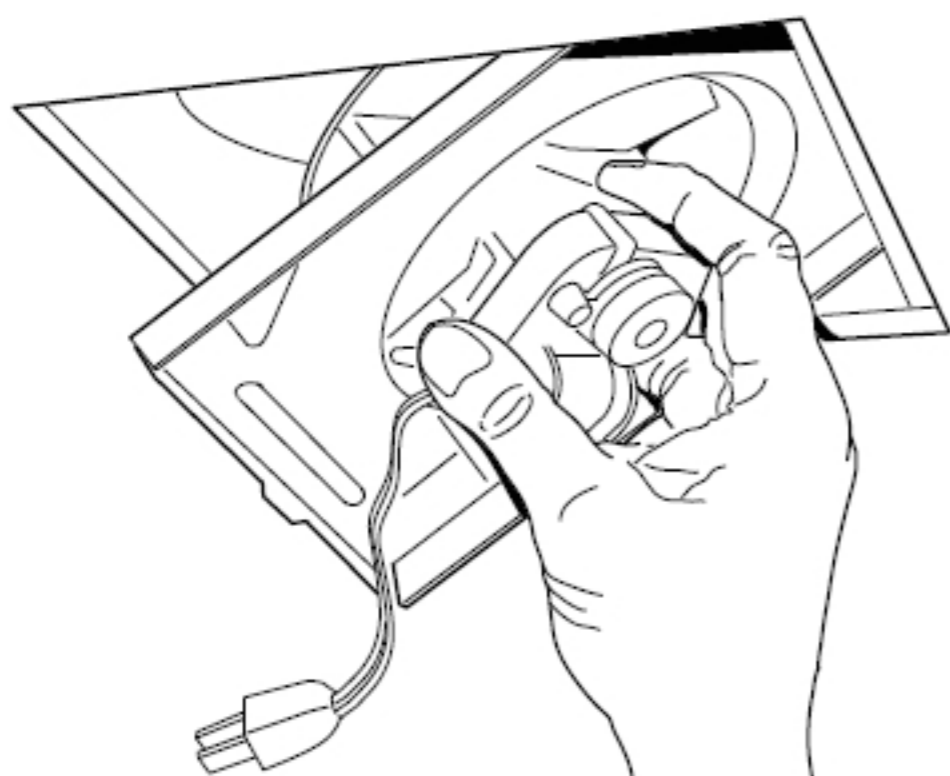

When motor plate tab disengages from housing slot, pivot blower assembly down and out.

-- 690 SERIES FAN ONLY --

3. Remove blower assembly from existing fan.

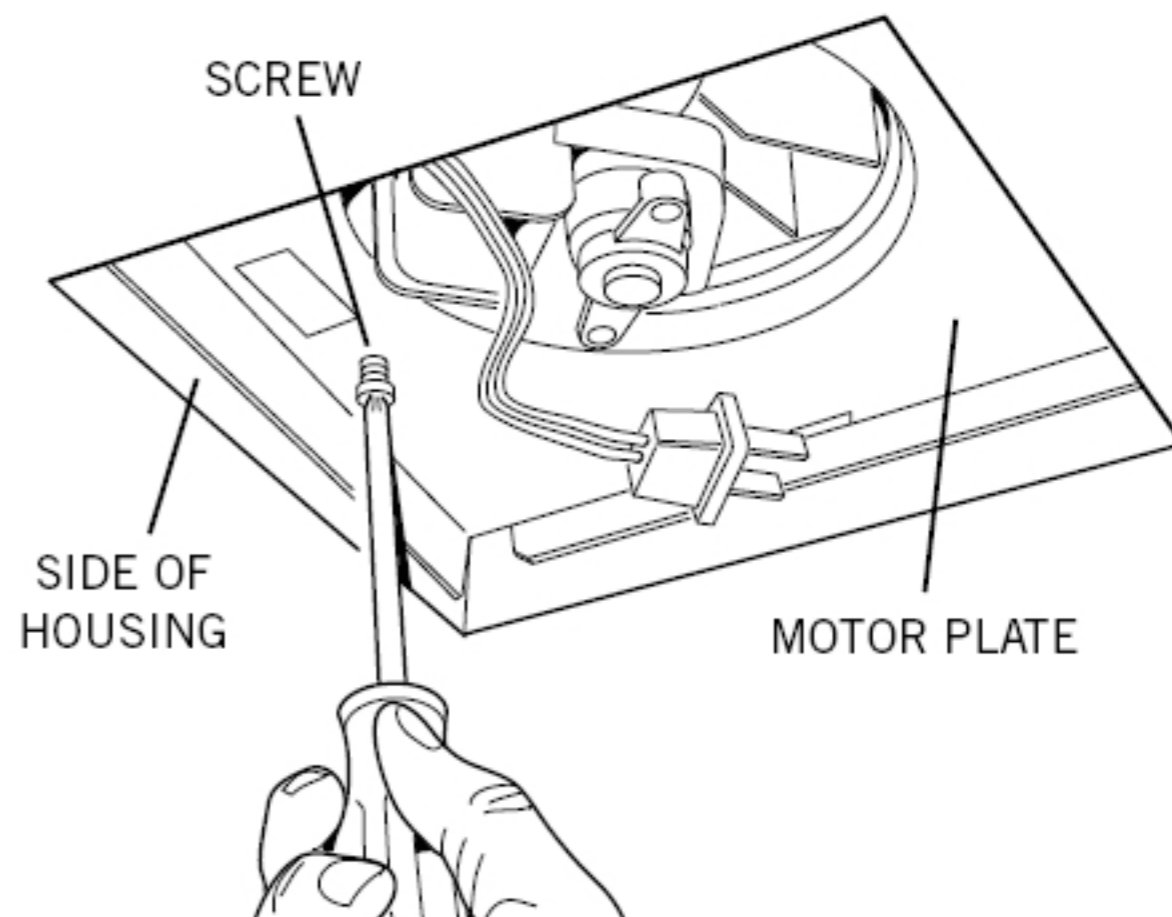

Unplug motor cord from receptacle and remove screw located next to receptacle. If necessary, insert a straight-blade screwdriver between motor plate and side of housing near the screw location and gently pry housing away from motor plate.

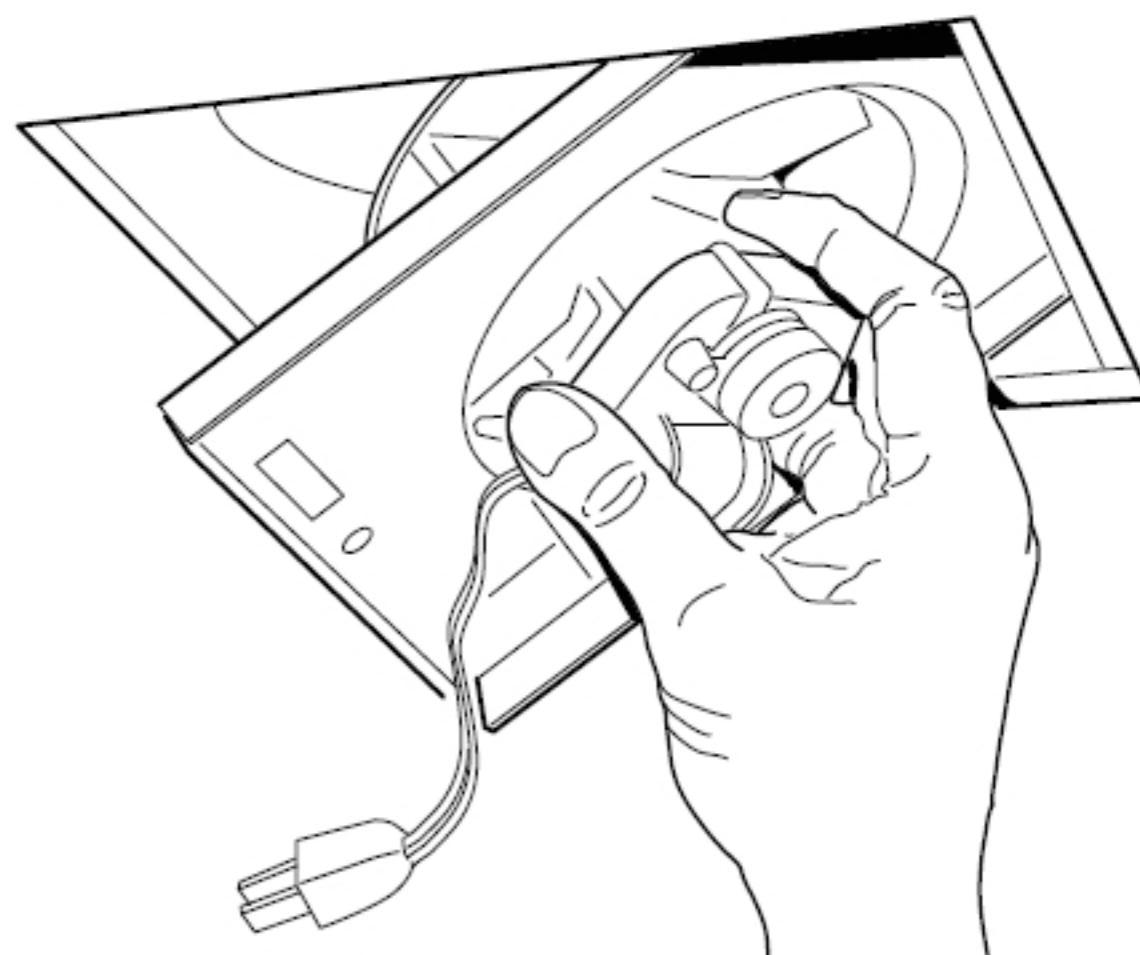

Pivot blower assembly down and out.

4. Check existing housing.

Vacuum the interior of the existing fan housing with a dusting brush attachment. Examine the housing to make sure it is securely fastened to the building structure and free of any holes caused by corrosion. The receptacle must be intact. If any damage is found, do not continue installation of this product. Contact a qualified person(s) for repair.

5. Compare old and new motor plates.

One of the two new motor plates is the same size as the motor plate from the existing fan. Use this motor plate in step 6.

6. Attach the new motor plate to the new wheel/motor assembly.

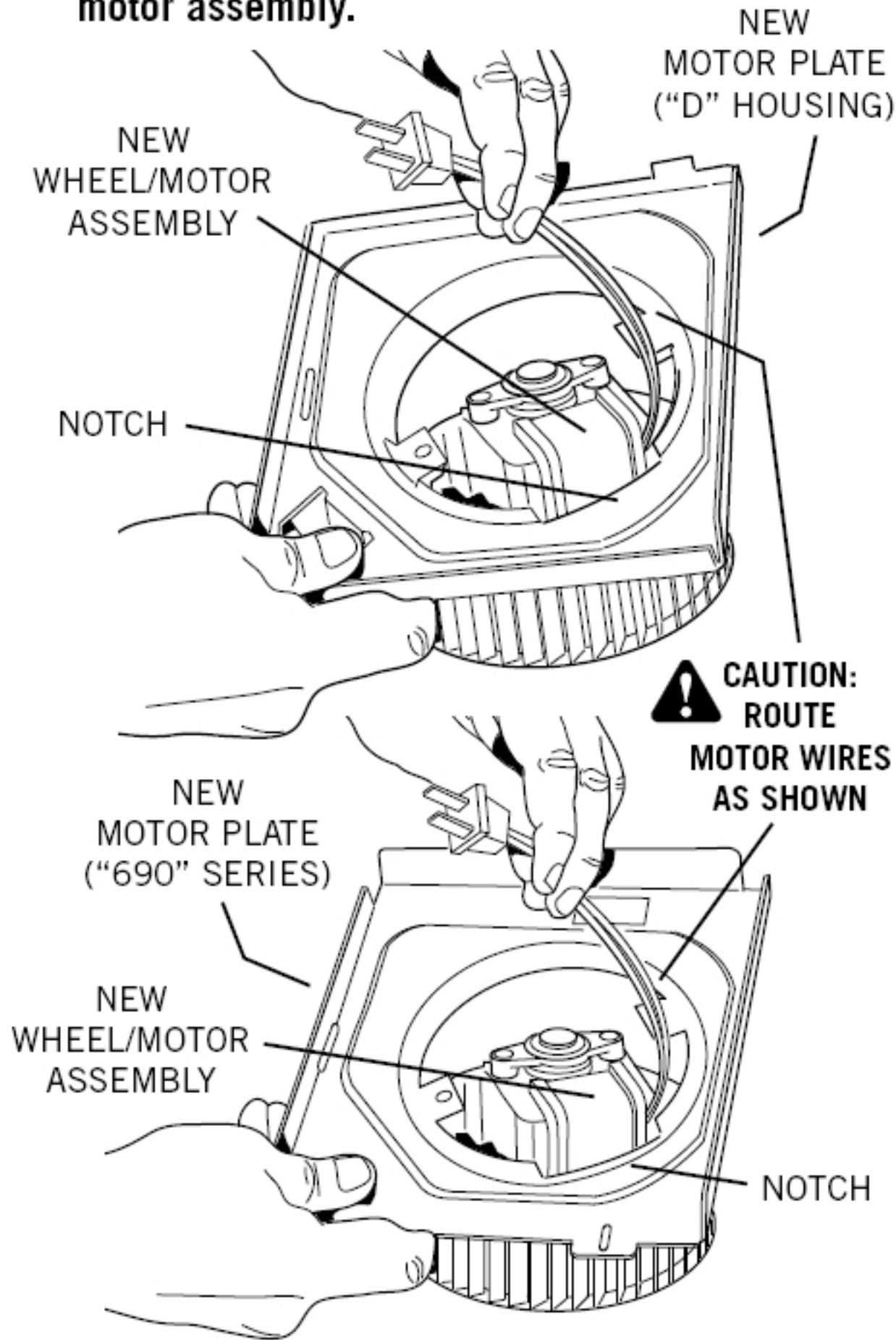

Set the new wheel/motor assembly on a flat surface with the motor facing up. Orient the new motor plate so that the specification label faces up and the motor body fits into the wide notch in the motor plate.

CAUTION: The motor lead wires must be routed through the motor plate as shown. Wires routed differently will become pinched or cut when the motor plate is installed into the housing. Electrical shock may result.

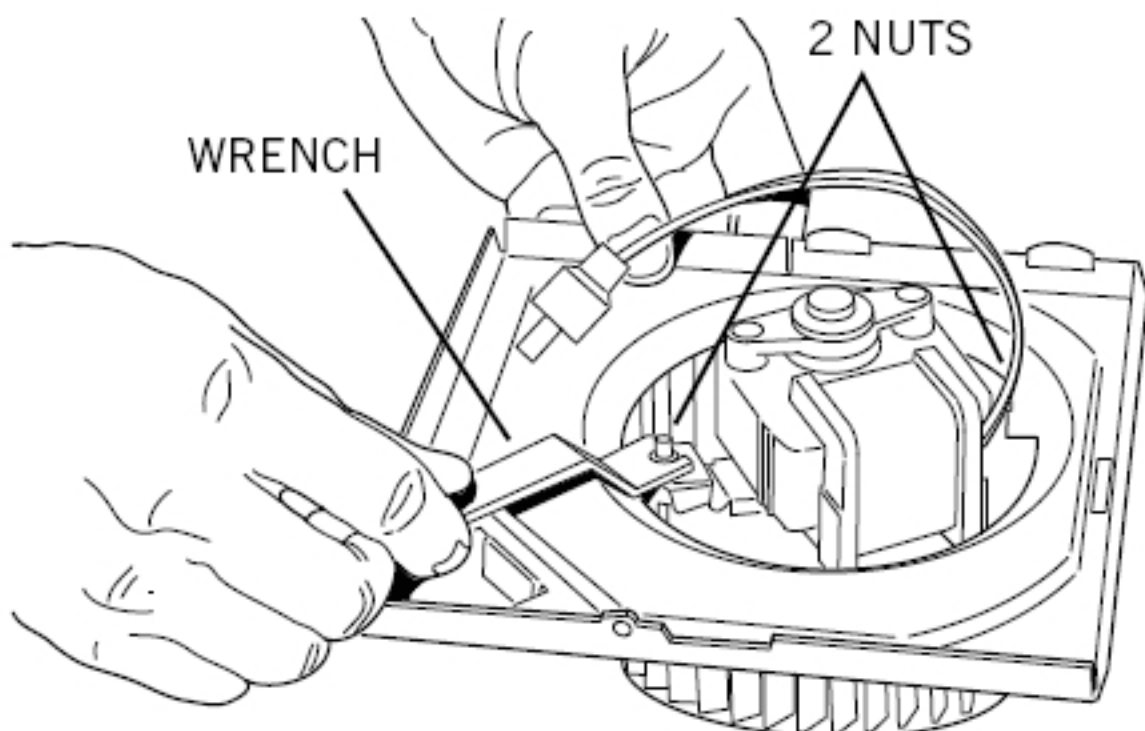

Place the new motor plate onto the motor bracket studs. Fasten parts together securely using two nuts and wrench provided.

7. Insert the new scroll band into the existing fan housing.

Note: Skip this step if the existing fan housing already contains a scroll band (plastic or metal).

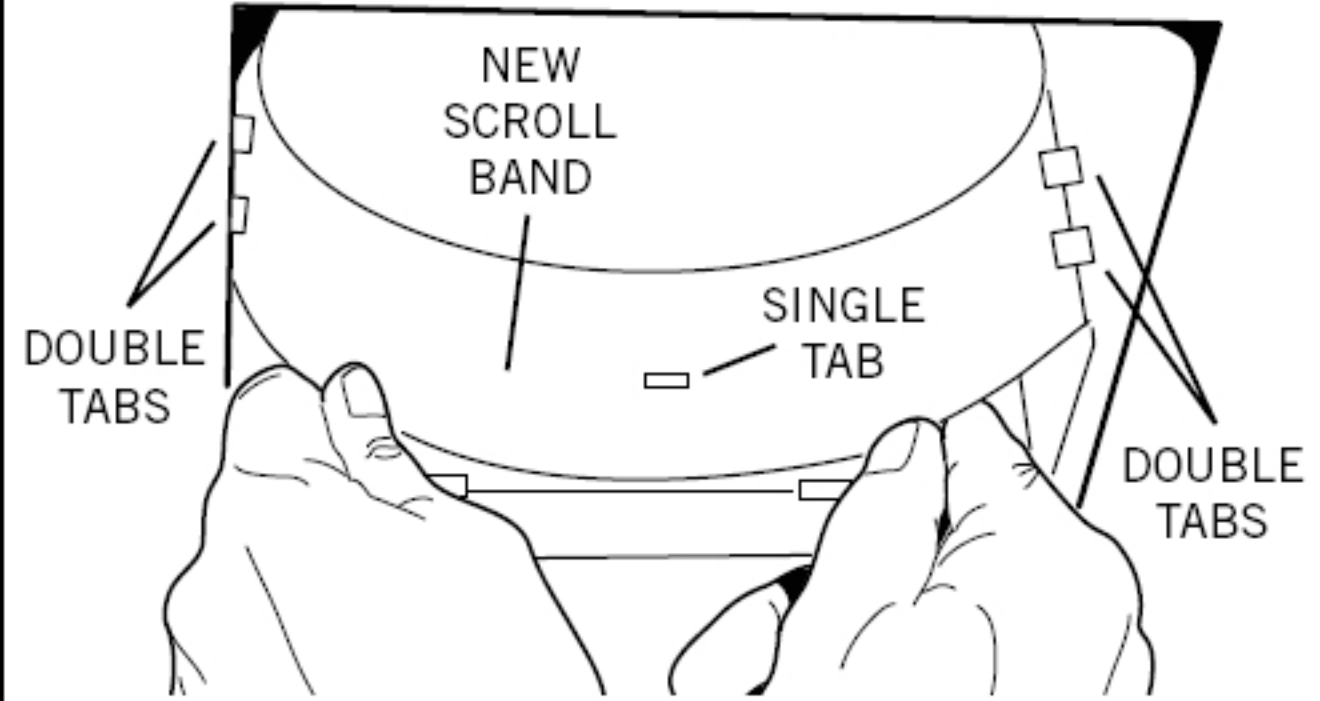

Bend it into a crescent shape and align one of the small slots in the scroll band with the single tab in the fan housing. Place the ends of the scroll band behind the double tabs in the fan housing, and release the scroll band.

-- D-HOUSING FAN ONLY --

8. Install new blower assembly into existing fan housing.

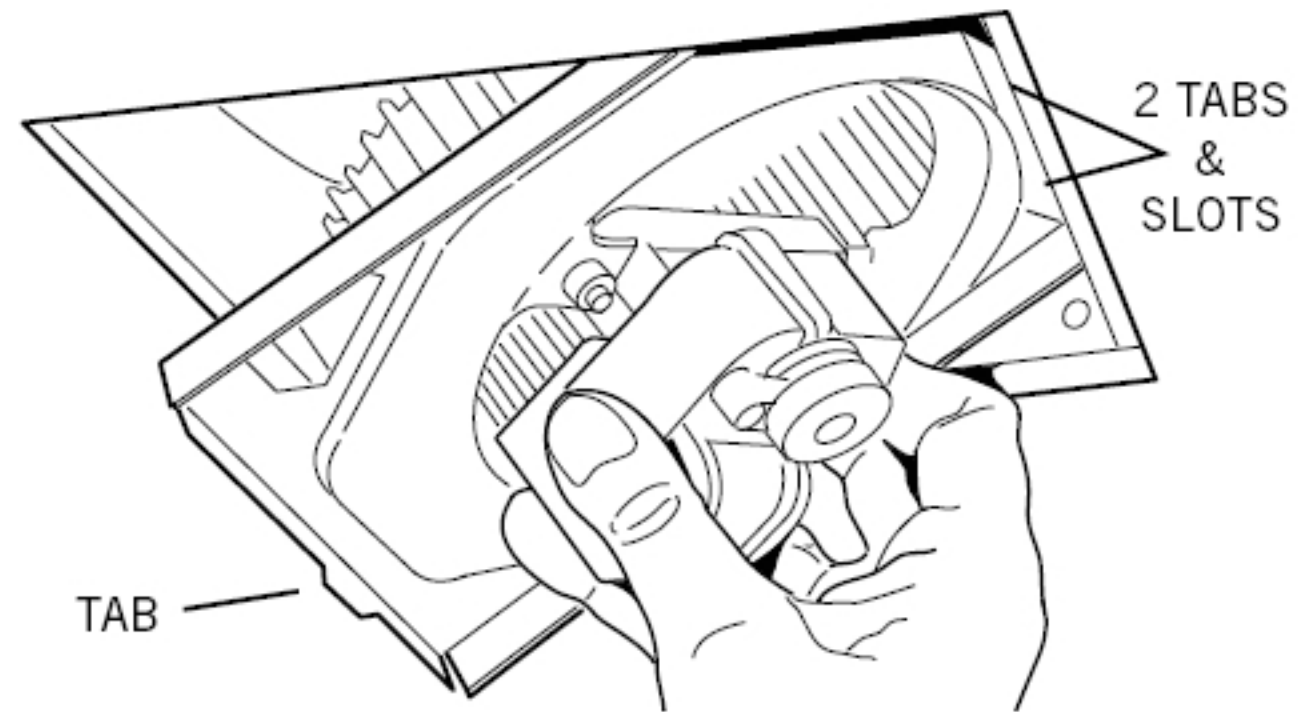

Insert two motor plate tabs into slots in housing and pivot blower assembly up until the third motor plate tab snaps into matching slot in housing. Make sure tabs hold blower assembly securely in place. Plug in motor.

-- 690 SERIES FAN ONLY --

8. Install new blower assembly into existing fan housing.

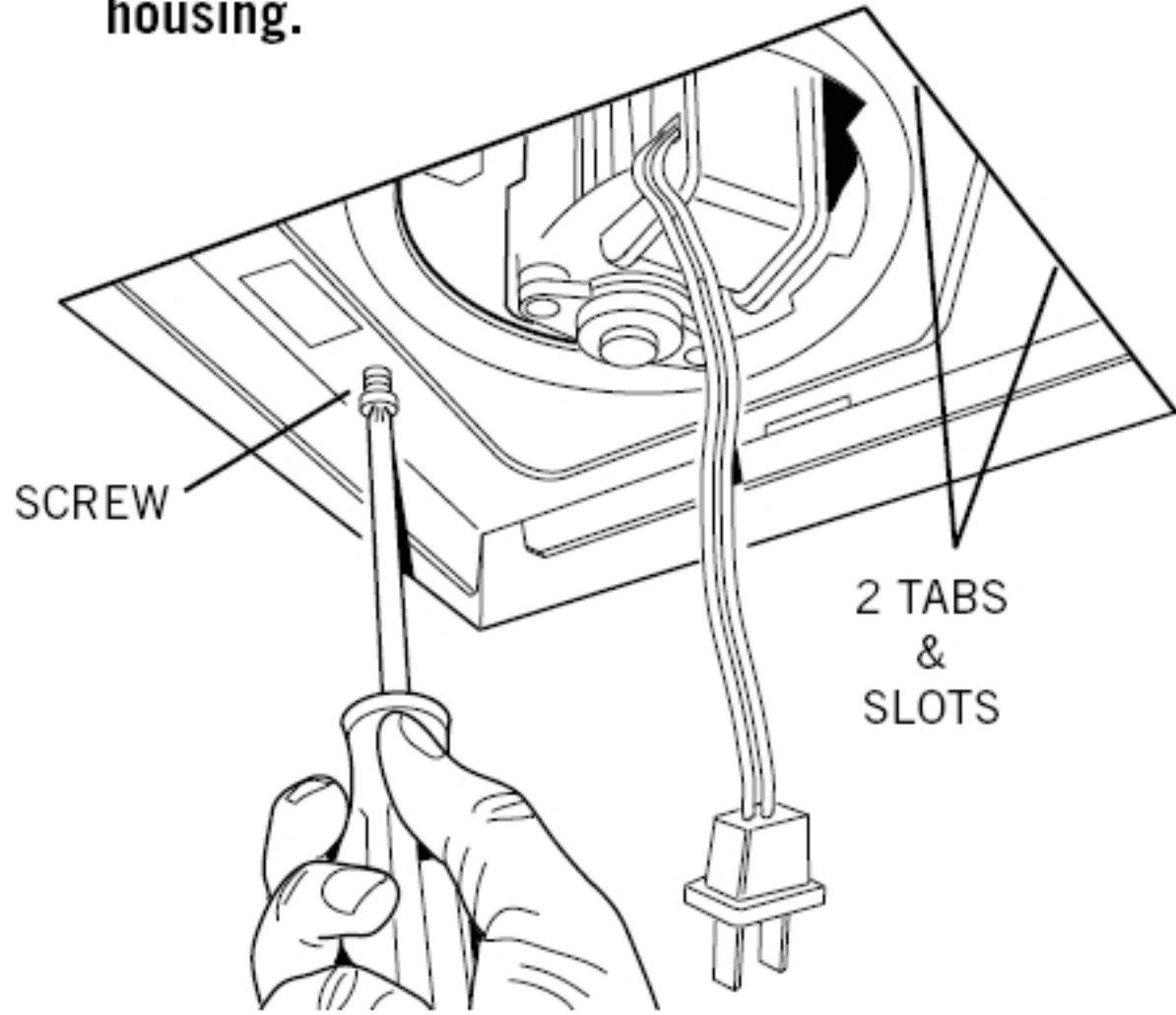

Insert two motor plate tabs into slots in housing and pivot blower assembly up until it is touching the wiring box. Secure in place with screw provided. Plug in motor.

9. Install new grille.

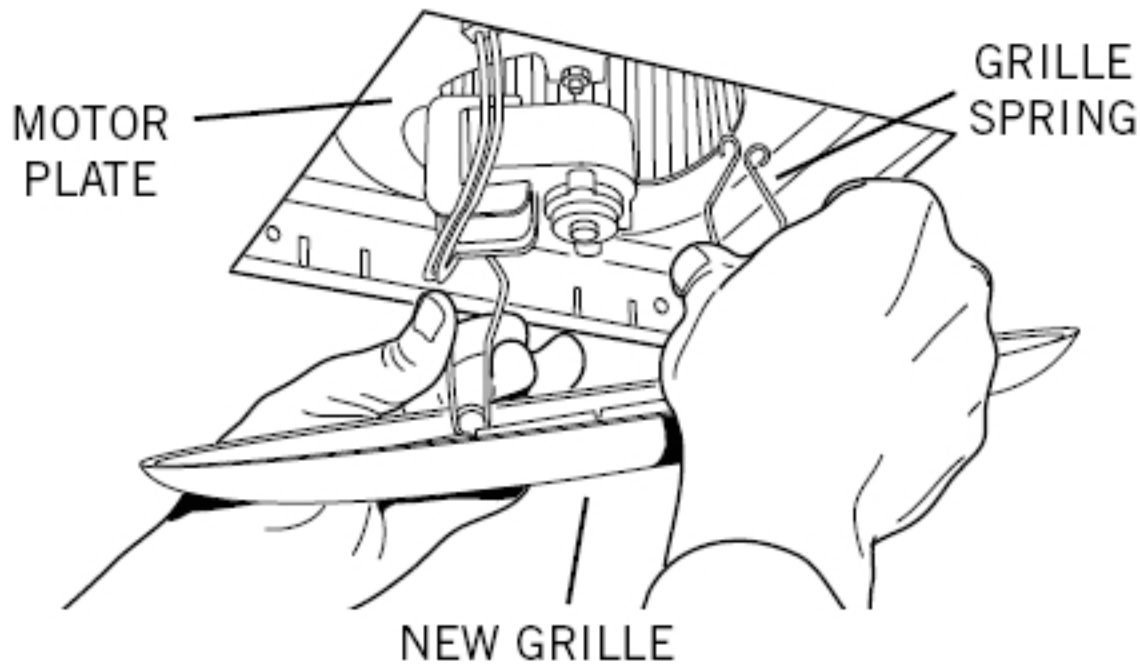

Squeeze one grille spring together and insert it into the matching slot in motor plate. Repeat with the other grille spring.

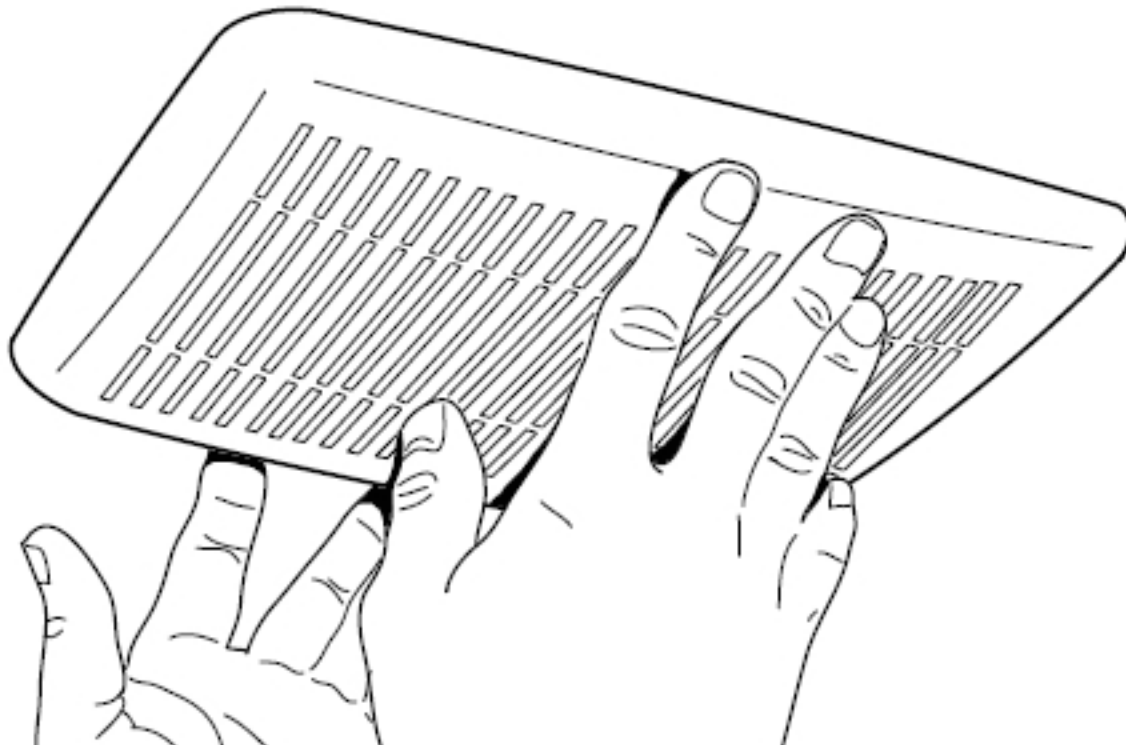

Push grille until it is tight against ceiling or wall.

SERVICE PARTS

Key No.	Part No.	Description
1	97016776	Grille Assembly (includes key no. 2)
2	99140198	Grille Spring (2 required)
3	98010267	Motor Plate ("D-Housing" fans)
4	98010268	Motor Plate ("690" Series fans)
5	99260423	Nut, Hex Flange #8-32 (2 required)
6	99150625	Screw #8-18 X .375
	97016924	Parts Bag (includes key nos. 5 & 6)
7	97016941	Motor/Bracket Assembly
8	97016962	Wheel
	97016923	Wheel/Motor Assembly (includes key nos. 7 & 8)
9	99111346	Scroll Band

Order replacement parts by "Part No.", not by "Key No."

