

This Owner's Manual is provided and hosted by [Appliance Factory Parts](#).



BROAN 511 Owner's Manual

[Shop genuine replacement parts for BROAN 511](#)



[Find Your BROAN HVAC Parts - Select From 1309 Models](#)

----- Manual continues below -----

MODELS 510 & 511 ROOM-TO-ROOM FANS

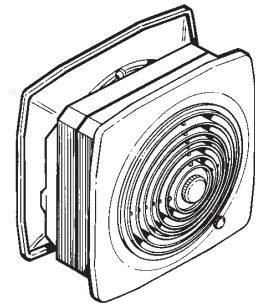

Easily installs in interior walls to move heated or cooled air from one room to another. Spreads heat from fireplaces, cool air from air conditioners to adjoining rooms.

FEATURES

GRILLE:

- Two contemporary styled grilles complement modern decor
- White polymeric grilles can be painted to match any decor

MOTOR:

- Permanently lubricated, thermally protected, plug-in motor
- Motor assembly offers fast, easy "twist-lock" installation
- Solid state speed control for fan speed and sound level selection

HOUSING:

- Requires 11-5/8" square hole through both interior walls
- Housing can be fastened to walls in several ways – allows flexibility to meet almost any mounting situation
- Adjustable housing fits walls from 3" to 5 1/2" thick
- Housing 25 gage finished with rugged black electrically-bonded epoxy paint

SPECIFICATIONS

MODEL	VOLTS	AMPS	RPM	SONES	CFM
510	120	1.7	1550	6.5	380
511	120	0.9	1575	4.5	180



HVI-2100 CERTIFIED RATINGS comply with new testing technologies and procedures prescribed by the Home Ventilating Institute, for off-the-shelf products, as they are available to consumers. Product performance is rated at 0.1 in. static pressure, based on tests conducted in AMCA's state-of-the-art test laboratory. Sones are a measure of humanly-perceived loudness, based on laboratory measurements.



TYPICAL SPECIFICATION

Ventilator shall be Broan Model 510 (Model 511).

Ventilator shall be installed in an interior wall 3" to 5 1/2" thick — NOT through a fire-rated wall.

Ventilator shall be steel housing finished with electrically-bonded epoxy paint. Grille to be white polymeric.

Motor assembly shall be removable and permanently lubricated. RPM shall not exceed 1550 (Model 510), 1575 (Model 511).

Air delivery shall be no less than 380 CFM and sound level no greater than 6.5 Sones (Model 510), 180 CFM and 4.5 Sones (Model 511). All air and sound ratings shall be certified by HVI. Units shall be U.L. listed.

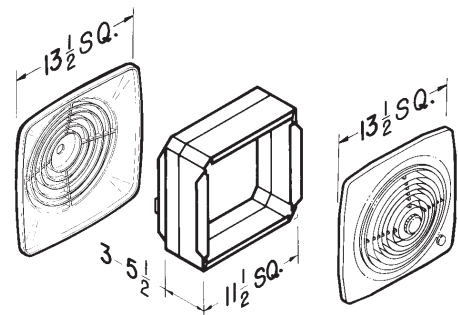

Broan-NuTone LLC, 926 West State Street, Hartford, WI 53027 (1-800-637-1453)

REFERENCE	QTY.	REMARKS	Project
			Location
			Architect
			Engineer
			Contractor
			Submitted by Date