

This Owner's Manual is provided and hosted by [Appliance Factory Parts](https://www.appliancefactoryparts.com).



BROAN L200 Owner's Manual

[Shop genuine replacement parts for BROAN L200](#)



[Find Your BROAN HVAC Parts - Select From 1309 Models](#)

----- Manual continues below -----

LOSONE SELECT® CEILING MOUNT VENTILATORS L100 SERIES & L150 SERIES

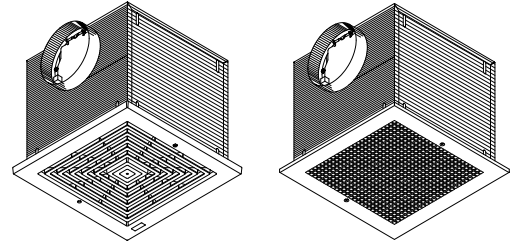

Incredibly reliable. Unbelievably quiet. Offering the CFM choices you need at the lowest sound levels in the industry.

FEATURES

GRILLE:

- Conceals interior
- Low profile styling blends with any decor
- White polymeric ("MG" models - metal, finished with white painted enamel)

BLOWER:

- Low RPM for quiet operation
- Resilient anti-vibration mounts
- Dynamically-balanced, polymeric, centrifugal blower wheel for quiet, efficient performance
- Permanently lubricated, thermally protected motor
- Plug-in motor rated at 120 VAC
- Designed for continuous operation

HOUSING:

- Rugged, 20 gauge galvanized steel
- 6" round duct connector
- 1/2" acoustic insulation inside
- May be installed in ceiling or wall (size permitting)
- 8-position mounting brackets for easy installation and greater adaptability to various mounting requirements
- Automatic backdraft damper located within duct connector
- Factory-shipped in horizontal discharge position - easily converted to vertical discharge
- May be installed as an in-line ventilator with addition of accessory kit Model 961L (see "Accessories")

ACCESSORIES (purchase all separately):

- Model 57V (Ivory) / 57W (White) Electronic Variable Speed Control
- Model 59V (Ivory) / 59W (White) 60-Minute Time Control
- Model 61V (Ivory) / 61W (White) 15-Minute Time Control
- Model 71V (Ivory) / 71W (White) 12-Hour Time Control
- Electronic Variable Speed Controls – Model 72V (120 VAC)
- Model 961L In-line Adapter Plate
- Model RD1 Radiation Damper
- Model 80L Electronic Speed Control (Internal)

TYPICAL SPECIFICATION

Ventilator shall be Broan Model L100, (L100MG), (L150), (L150MG).

Ventilator shall have galvanized steel housing insulated with at least 1/2" of acoustic insulation. Housing to have adjustable mounting brackets.

Automatic backdraft damper to be located within duct connector. Duct connector, blower assembly and wiring plate shall be adjustable for either horizontal or vertical installation.

Blower unit shall be removable from housing and will have a polymeric, dynamically balanced centrifugal-type blower wheel. Motor to be permanently lubricated and mounted with resilient anti-vibration mounts. RPM not to exceed number listed for each model.

Air delivery shall be no less and sound levels no greater than listed for each model. All air and sound ratings shall be certified by AMCA. Units to be UL and cUL listed.



"Broan-NuTone LLC certifies that the models shown herein are licensed to bear the AMCA Seal. The ratings shown are based on tests and procedures performed in accordance with AMCA Publication 211 (and AMCA Publication 311 if sound is also certified) and comply with the requirements of the AMCA Certified Ratings Program"



Models L100 and L150 are UL listed for use over bathtubs and showers when connected to a GFCI-protected branch circuit.

Broan-NuTone LLC, 926 West State Street, Hartford, Wisconsin 53027 (1-800-637-1453)
Broan-NuTone Canada, 1140 Tristar Drive, Mississauga, Ontario, L5T 1H9 (1-888-882-7626)

REFERENCE	QTY.	REMARKS	Project
			Location
			Architect
			Engineer
			Contractor
			Submitted by Date

PERFORMANCE RATINGS - LOSONE SELECT® CEILING MOUNT VENTILATORS L100 SERIES & L150 SERIES

AMCA LICENSED PERFORMANCE

CFM / SONES - AT STATIC PRESSURES (Ps - inches of H ₂ O)																
MODEL NO.	NOMINAL VOLTAGE		0.0" Ps	.10" Ps	.125" Ps	.250" Ps	.375" Ps	.50" Ps	.625" Ps	.750" Ps	.875" Ps	1.0" Ps	NOMINAL RPM	AMPS @60 Hz	WATTS	
L100	120 VAC	CFM Hor.	136	115	109	93	80	65	44	12			640	1.1	87	
		SONES Hor.	0.5	0.8	0.9	1.3	1.8	2.3	3.0	3.2						
		CFM Ver.	138	117	112	94	80	67	46	13				650	1.1	87
		SONES Ver.	0.7	0.9	1.0	1.3	1.8	2.2	2.8	3.0						
L100MG	120 VAC	CFM Hor.	144	121	115	97	83	68	46	12			630	1.1	87	
		SONES Hor.	0.5	0.8	0.9	1.2	1.8	2.4	3.0	3.3						
		CFM Ver.	142	119	115	95	80	67	45	13				640	1.1	87
		SONES Ver.	0.5	0.8	0.9	1.4	1.8	2.3	2.9	3.1						
L150	120 VAC	CFM Hor.	181	161	157	141	132	124	114	94	62		710	1.3	100	
		SONES Hor.	1.3	1.4	1.5	2.2	2.6	3.1	3.6	4.1	4.6					
		CFM Ver.	179	163	160	149	142	133	122	105	73	23	750	1.3	100	
		SONES Ver.	1.4	1.6	1.6	2.0	2.5	3.0	3.3	3.6	3.9	4.2				
L150MG	120 VAC	CFM Hor.	184	165	161	148	141	135	126	108	74	19	710	1.3	100	
		SONES Hor.	1.1	1.4	1.4	1.9	2.3	2.8	3.2	3.8	4.1	4.5				
		CFM Ver.	183	165	162	151	143	135	124	107	76	26	725	1.3	100	
		SONES Ver.	1.4	1.6	1.6	2.0	2.5	3.0	3.3	3.6	4.0	4.4				

Performance ratings include the effects of inlet grille and backdraft damper in the airstream. Speed (RPM) shown is nominal. Performance is based on actual speed of test. The sound ratings shown are loudness values in fan sones at 5' (1.5m) in a hemispherical free field calculated per AMCA Std. 301. Values shown are for Installation Type B: Free inlet fan sone levels. Performance shown is for Installation Type B: Free inlet, Ducted outlet.



"Broan-NuTone LLC certifies that the models shown herein are licensed to bear the AMCA Seal. The ratings shown are based on tests and procedures performed in accordance with AMCA Publication 211 (and AMCA Publication 311 if sound is also certified) and comply with the requirements of the AMCA Certified Ratings Program."



Models L100 and L150 are UL listed for use over bathtubs and showers when connected to a GFCI-protected branch circuit.

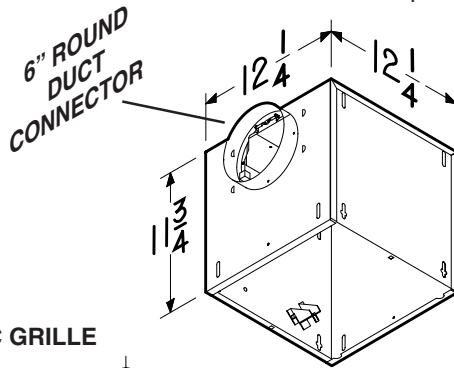
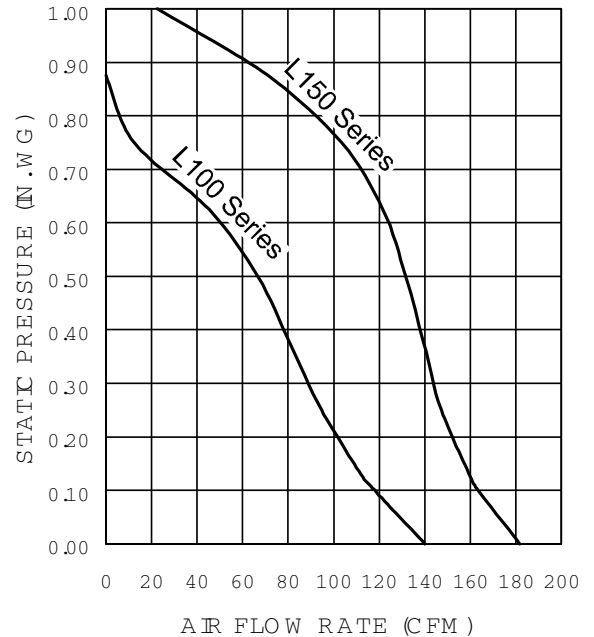

POLYMERIC GRILLE MODELS
L100
L150

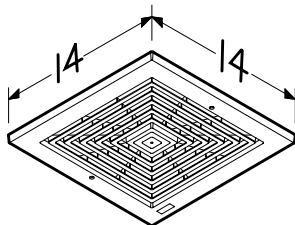

METAL GRILLE MODELS
L100MG
L150MG

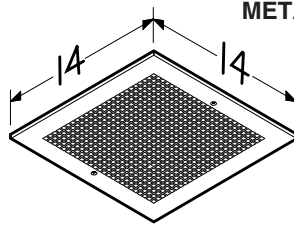

WEIGHT

MODEL NO.	SHIPPING WT.
L100	22.8 lbs.
L100MG	23.7 lbs.
L150	23.1 lbs.
L150MG	23.7 lbs.



Broan-NuTone LLC, 926 West State Street, Hartford, Wisconsin 53027 (1-800-637-1453)
Broan-NuTone Canada, 1140 Tristar Drive, Mississauga, Ontario, L5T 1H9 (1-888-882-7626)