

This Owner's Manual is provided and hosted by [Appliance Factory Parts](#).



BROAN L150MG Owner's Manual

[Shop genuine replacement parts for BROAN L150MG](#)



[Find Your BROAN HVAC Parts - Select From 1309 Models](#)

----- Manual continues below -----

BROAN®

LOSONE SELECT® VENTILATORS

Ceiling/Wall Mount

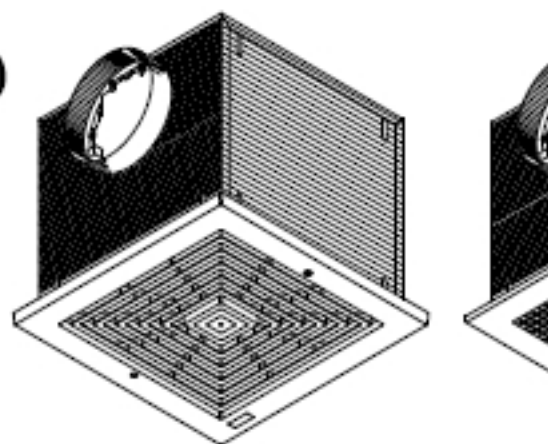

READ AND SAVE TH

WARNING



TO REDUCE THE RISK OF FIRE, ELECTRIC SHOCK, OR INJURY TO PERSONS, OBSERVE THE FOLLOWING:

1. Use this unit only in the manner intended by the manufacturer. If you have questions, contact the manufacturer at the address or telephone number listed in the warranty.
2. Before servicing or cleaning unit, switch power off at service panel and lock the service disconnecting means to prevent power from being switched on accidentally. When the service disconnecting means cannot be locked, securely fasten a prominent warning device, such as a tag, to the service panel.
3. Installation work and electrical wiring must be done by a qualified person(s) in accordance with all applicable codes and standards, including fire-rated construction codes and standards.
4. Sufficient air is needed for proper combustion and exhausting of gases through the flue (chimney) of fuel burning equipment to prevent backdrafting. Follow the heating equipment manufacturer's guideline and safety standards such as those published by the National Fire Protection Association (NFPA), and the American Society for Heating, Refrigeration and Air Con-

BROAN®

TYPICAL INSTALLATION

MOUNTING *(New Frame Construction)*

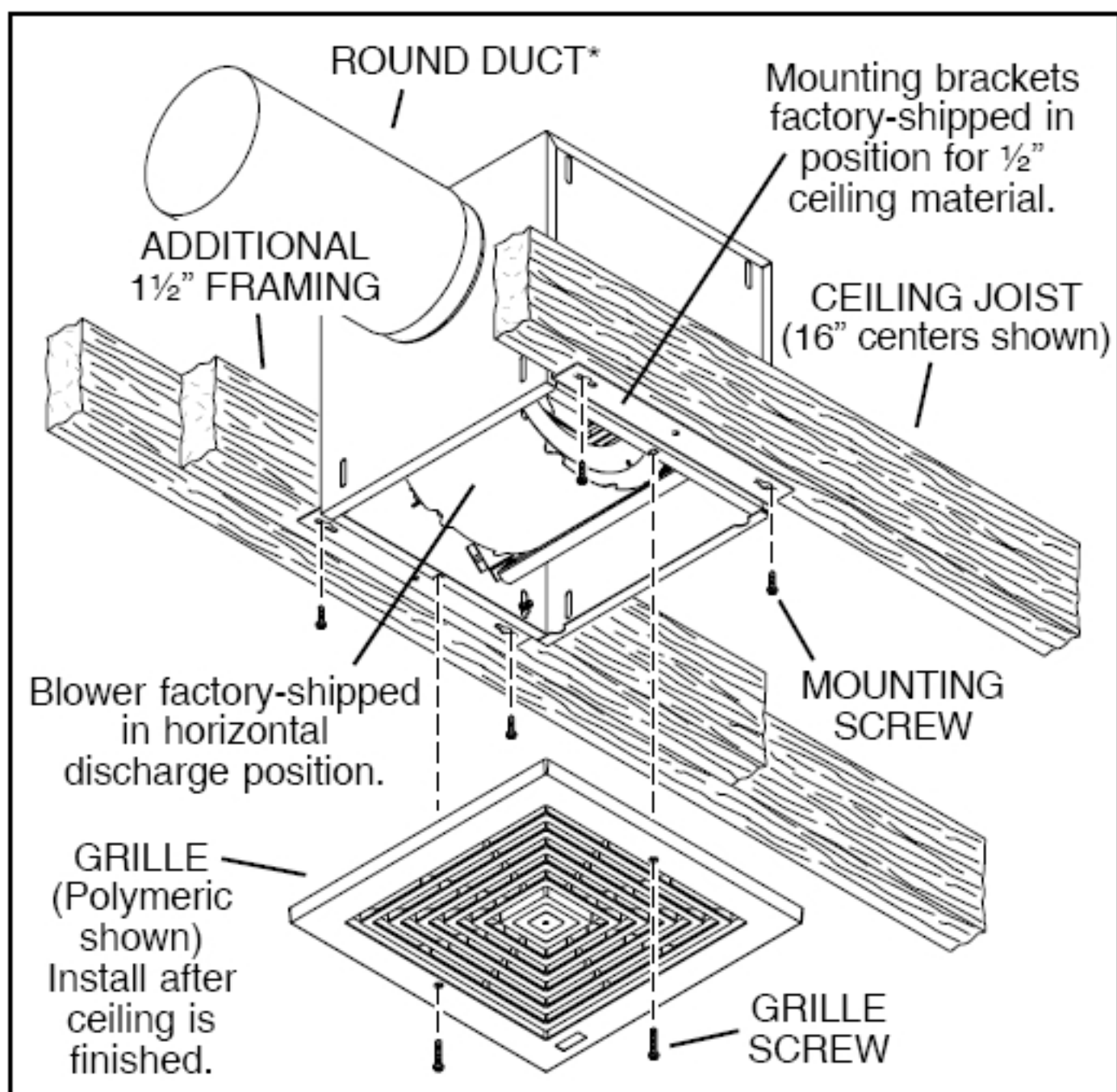

Factory-shipped unit installed in new construction.



MOUNTING OPTIONS

1/4-20 hex nuts secure mounting brackets to housing. Loosen and re-tighten or remove and replace nuts as necessary for desired mounting bracket position.

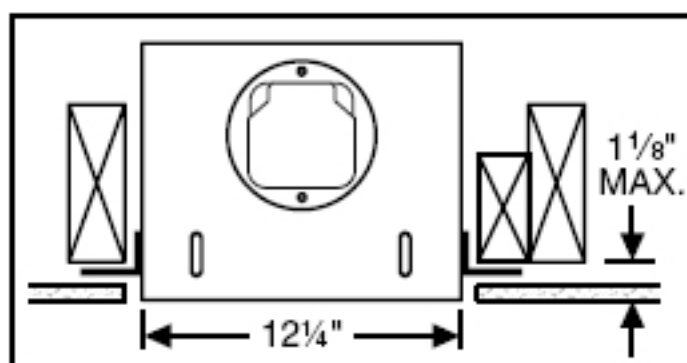

Mounting brackets in factory-shipped position. (Outlet parallel to joists.) (New construction)

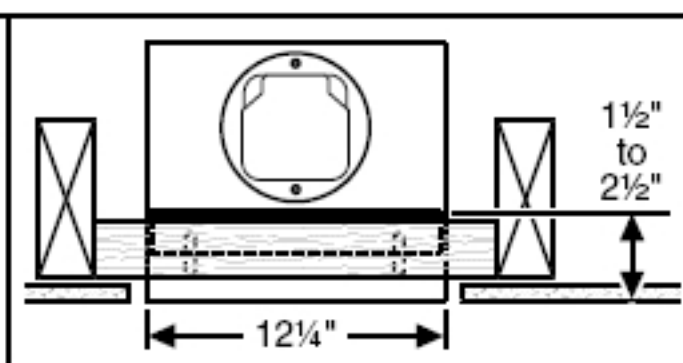

Mounting brackets flipped over and mounted to outlet sides of housing. (Outlet parallel to joists.) (Existing construction)

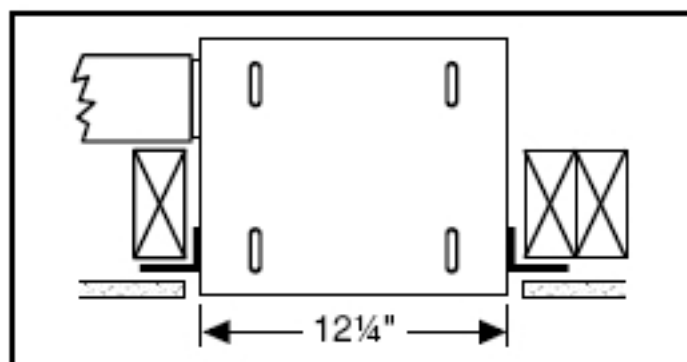

Mounting brackets mounted to outlet sides of housing. (Outlet perpendicular to joists.) (New construction)

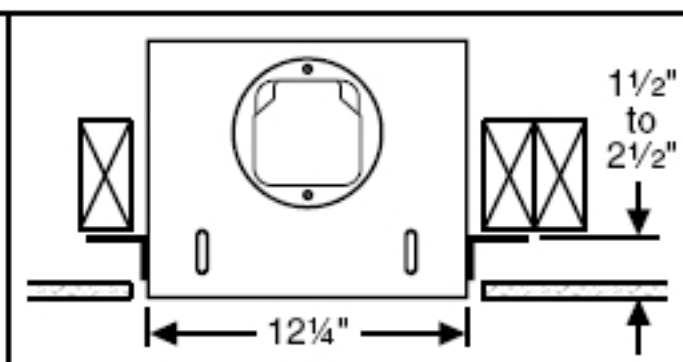

Mounting brackets flipped over to give approx. 1" more clearance. (Outlet parallel to joists.) (New construction)



SERVICE PARTS

KEY NO.	PART NO.	DESCRIPTION
1	97014725	Housing Assembly (L100's & L150's)
	97014726	Housing Assembly (L200's thru L300's)
2	97014728	Mounting Bracket (2 req.)
3	97014760	Damper Assembly (6" dia.)
	97014761	Damper Assembly (8" dia.)
4	99150415	Screw, 8-18 x 1/4 (12 req.)*
5	98005513	Wire Box Cover
6	99400035	Strain Relief Bushing
7	98005512	Wiring Plate
8	99150471	Ground Screw, 10-32 x 1/2 (2 req.)
9	97014774	Scroll Assembly (L100's & L150's)
	97014775	Scroll Assembly (L200's thru L300's)
10	98009399	Inlet Ring
11	99110805	Blower Wheel
12	99080481	Motor (L100 & L100MG)
	99080482	Motor (L150 & L150MG)
	99080483	Motor (L200 & L200MG)
	99080484	Motor (L250 & L250MG)
	99080485	Motor (L300 & L300MG)
	99080493	Motor (L100C)
	99080494	Motor (L150C)
	99080495	Motor (L200C)
	99080496	Motor (L250C)
	99080497	Motor (L300C)
	99080503	Motor (L100EX)
	99080504	Motor (L150EX)
	99080505	Motor (L200EX)
	99080506	Motor (L250EX)
	99080507	Motor (L300EX)
13	99260558	Lock Nut, 8-32 (4 req.)*
14	99250959	Washer (4 req.)*
15	99100491	Grommet (4 req.)
9-15		Blower Assembly, Complete