

This Owner's Manual is provided and hosted by [Appliance Factory Parts](#).



BROAN RM503623 Owner's Manual

[Shop genuine replacement parts for BROAN RM503623](#)



[Find Your BROAN HVAC Parts - Select From 1309 Models](#)

----- Manual continues below -----

RM50000 SERIES (RANGEMASTER®) by Broan-NuTone RANGE HOOD

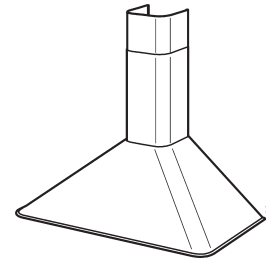

A combination of Italian chimney hood design with tremendous value to meet the requirements of today's conventional appliance and kitchen styles.

FEATURES

- Professional style design
- Finishes: 430 Stainless Steel #4 Brushed, White, Black
- Wall mount installation
- Seamless corners for easy cleaning
- Ducted/non-ducted telescopic flue - fits 8 ft. to 9 ft. ceilings
- 6" round duct connector/backdraft damper
- Includes non-ducted kit for indoor exhaust recirculation
- 270 cfm centrifugal blower
- Multi-speed slide control
- Dual incandescent lighting (2 x 40 W) (bulbs included)
- Dishwasher-safe aluminum filter features a quick-release latch and professional style appearance
- Available sizes: 30", 35-7/16"

OPTIONS

- Replacement grease filter and bulbs available
- Replacement charcoal filters available (Model FILTEREB40 or Part No. SB03300495)
- Flue Extension for 10-ft. ceiling (ducted applications) (Model RFX50 series in Stainless Steel, White and Black — 35" long)
- Flue Extension for 10-ft. ceiling (non-ducted applications) (Model RFXN5004 in Stainless Steel only — 35" long)

SPECIFICATIONS

VOLTS	AMPS	CFM	SONES	DUCT
120	2.86	270	6.5	6" round



Broan-NuTone LLC Hartford, Wisconsin www.broan.com 800-558-1711
Broan-NuTone Canada Mississauga, Ontario www.broan.ca 877-896-1119



HVI-2100 CERTIFIED RATINGS comply with new testing technologies and procedures prescribed by the Home Ventilating Institute, for off-the-shelf products, as they are available to consumers. Product performance is rated at 0.1 in. static pressure, based on tests conducted in a state-of-the-art test laboratory. Sones are a measure of humanly-perceived loudness, based on laboratory measurements.

TYPICAL SPECIFICATION

Range hood shall be Broan Model RM50000.

Unit shall be for indoor use only.

Unit shall be convertible between ducted (using a washable aluminum filter) and non-ducted (using a recirculation kit).

Motor to be permanently lubricated.

Unit shall have four-speed fan switch and separate light switch.

Sides shall be mitered and bottom edge hemmed - with no sharp edges.

Air delivery shall be no less than 270 CFM.

Unit shall be U.L. and cUL listed.

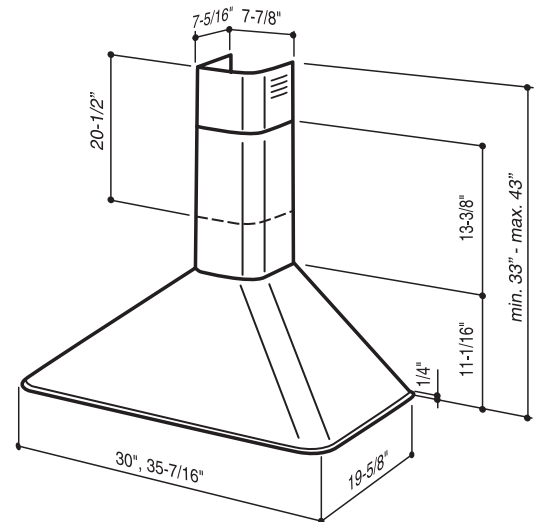

REFERENCE	QTY.	REMARKS	Project
			Location
			Architect
			Engineer
			Contractor
			Submitted by Date

RM50000 SERIES WIRING

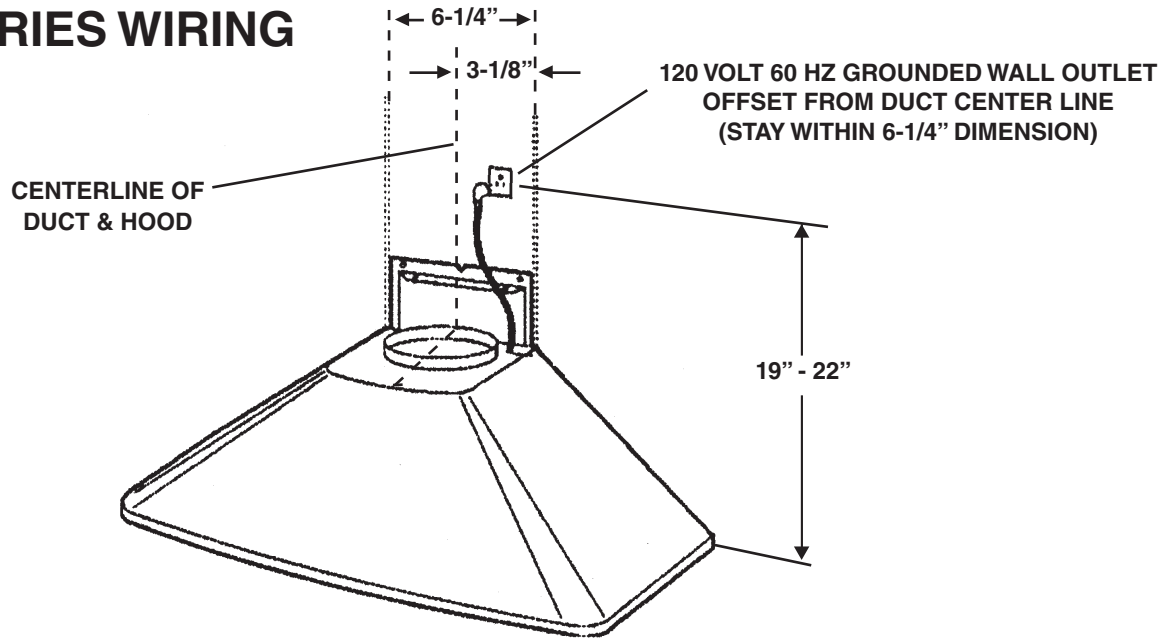

RM50000 SERIES MOUNTING

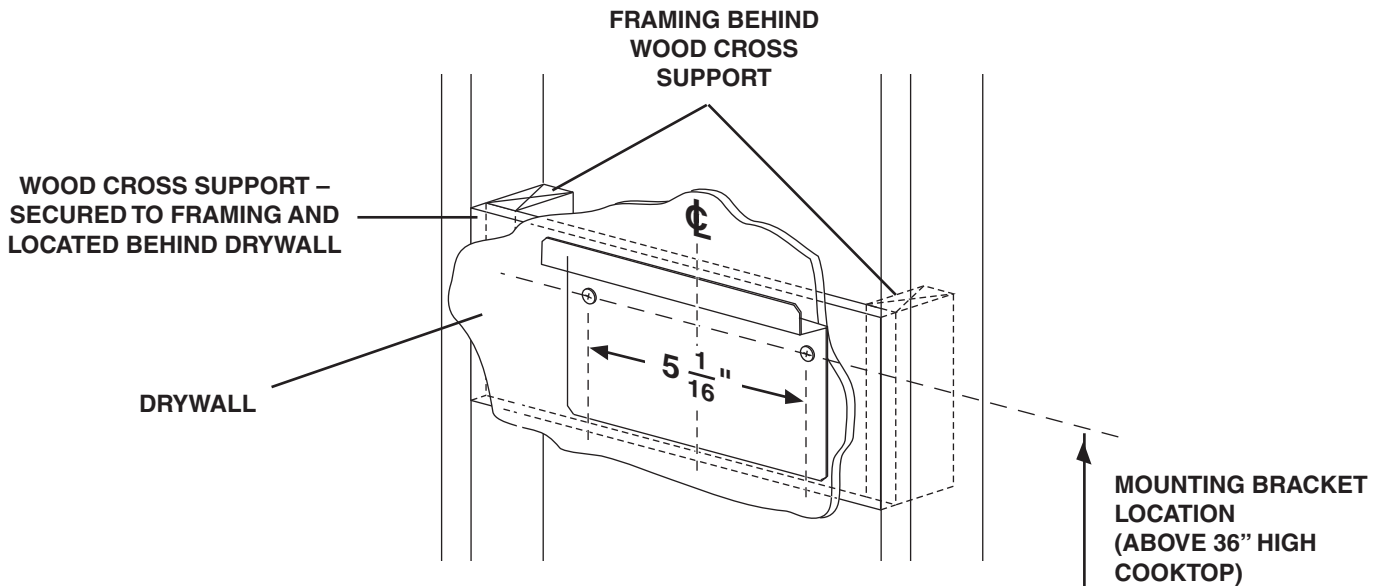

CEILING HEIGHT	DUCT METHOD	MOUNTING DISTANCE ABOVE 36" HIGH COOKTOP (SEE NOTE 1)						
		24"	25"	26"	27"	28"	29"	30"
8 FEET	DUCTED OR NONDUCTED	37"	38"	39"	40"			
9 FEET	DUCTED OR NONDUCTED						42"	43"
10 FEET	DUCTED OR NONDUCTED (SEE NOTE 2)				40"	41"	42"	43"

NOTES:

1. Minimum hood distance above cooktop must not be less than 24".
A maximum of 30" above the cooktop is highly recommended for best capture of cooking impurities.
Distances over 30" above the cooktop are at the installer's and user's discretion - providing that ceiling height and flue length permit.
2. Requires optional 10-foot flue extension model RFX5004 (ducted) or RFXN5004 (non-ducted).

BROAN® *Elite*

(RANGEMASTER®
by Broan-NuTone)

Broan-NuTone LLC Hartford, Wisconsin www.broan.com 800-558-1711
Broan-NuTone Canada Mississauga, Ontario www.broan.ca 877-896-1119